

REAR BUMPER 2022-UP/TOYOTA TUNDRA R7602350901NA

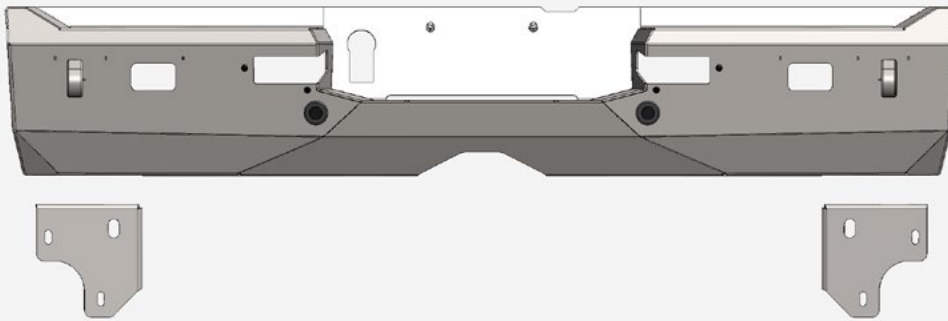

TOOLS REQUIRED

- 8mm, 5/16, 7/16, 9/16, 11/16, 3/8, 7/8, 1/2 sockets
- 8mm, 5/16, 7/16, 9/16, 11/16, 3/8, 7/8, 1/2 wrenches
- Pushpin Puller or Flathead Screwdriver
- Phillips Screwdriver
 - 5/32 Allen
- Needle Nose Pliers
 - Grinder
 - Razor Blade

SKILL LEVEL

- Medium

TIME REQUIRED

- Approximately 2 Hours (This installation guide covers the installation of the product only. It does not include instructions and time for wiring)

WARNINGS/CAUTIONS BEFORE STARTING INSTALLATION

-BEFORE YOU INSTALL THIS KIT-

Read and understand all instructions, warnings, cautions, & notes contained in this installation instruction guide. Consult your vehicle owner's manual for proper disconnection of electrical and lifting of vehicle if required for installation of this product.

This install may require some technical skills and knowledge of basic mechanical work. If you do not feel that you are capable of performing this install please take this product to a trained professional.

After reading this guide please contact us with any questions or concerns before installing product.

Customer Service: 830-896-7571
Rago Fabrication is **not** responsible for any bodily injury or harm to you or your vehicle as a result of an improper install.

Proper installation of this kit required knowledge of the factory recommended procedures for removal and installation of original equipment components.

We recommend that the factory shop manual and any special tools needed to service your vehicle be on hand during the installation. Installation of this kit without proper knowledge of the factory recommended procedures may affect the

performance of these components and the safety of the vehicle. Inspect all contents of this package to make sure product is not damaged and all installation hardware has been included. If parts are missing from kit, please be prepared to provide the following information:

1. Name of purchase location
2. Bar Code on side of box
3. Date above bar code
4. Date inside box cover

***ALWAYS WEAR EYE PROTECTION
WHEN OPERATING POWER TOOLS***

HARDWARE

A.



1/4-20 X 1" BUTTON HEAD BOLT

QTY: 4

A1.



1/4-20" NYLON LOCK NUT

QTY: 6

B.

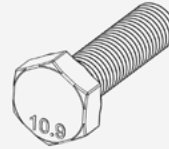

M10 - 1.25 X 35MM HEX HEAD BOLT

QTY: 2

B1.



3/8" FLAT WASHER ZINC

QTY: 2

C.

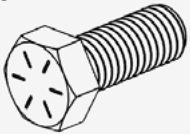

3/8-16 X 1" HEX HEAD BOLT YELLOW

QTY: 2

C1.



3/8" FLAT WASHER YELLOW

QTY: 4

C2.

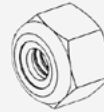

3/8-16 NYLON LOCK NUT YELLOW

QTY: 2

D.

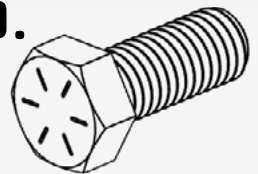

1/2-13 X 1 1/2" HEX HEAD BOLT

QTY: 6

D1.



1/2" FLAT WASHER

QTY: 12

D2.

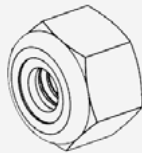

1/2-13" NYLON LOCK NUT

QTY: 6

E.



1/4" HEX SCREW

QTY: 2

E1.



1/4" PLASTIC SNAP IN NUT

QTY: 2

F.



3M DOUBLE SIDE TAPE 1X1 SQUARE

QTY: 4

G.



Isolator Grommet
SGONRB2-92118918

QTY: 2

SENSOR GROMMETS SUPPLIED FOR NON SENSOR TRIMS



7/8 RUBBER GROMMET

QTY: 2



7/8 PLASTIC PLUG

QTY: 2



□ STEP 1

Unplug/remove the trailer plug on the backside of the bumper using a (flathead screwdriver) to release clips.

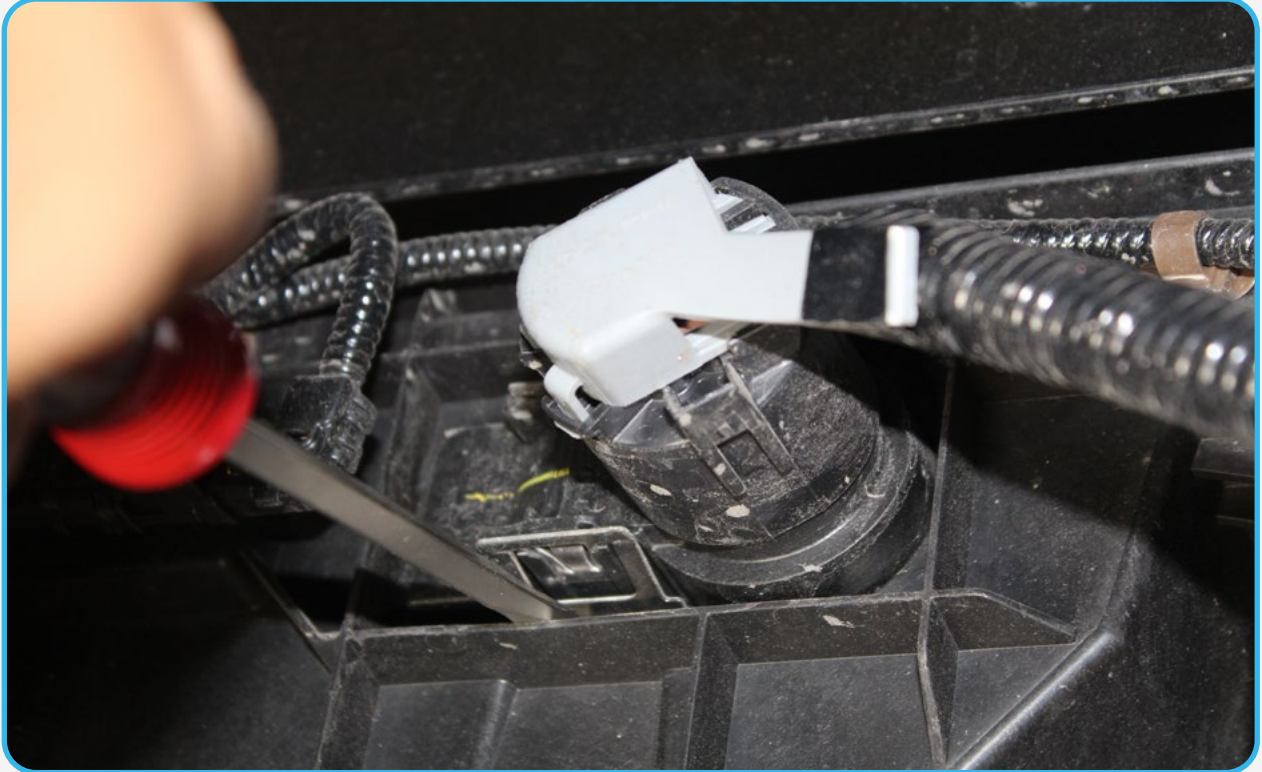
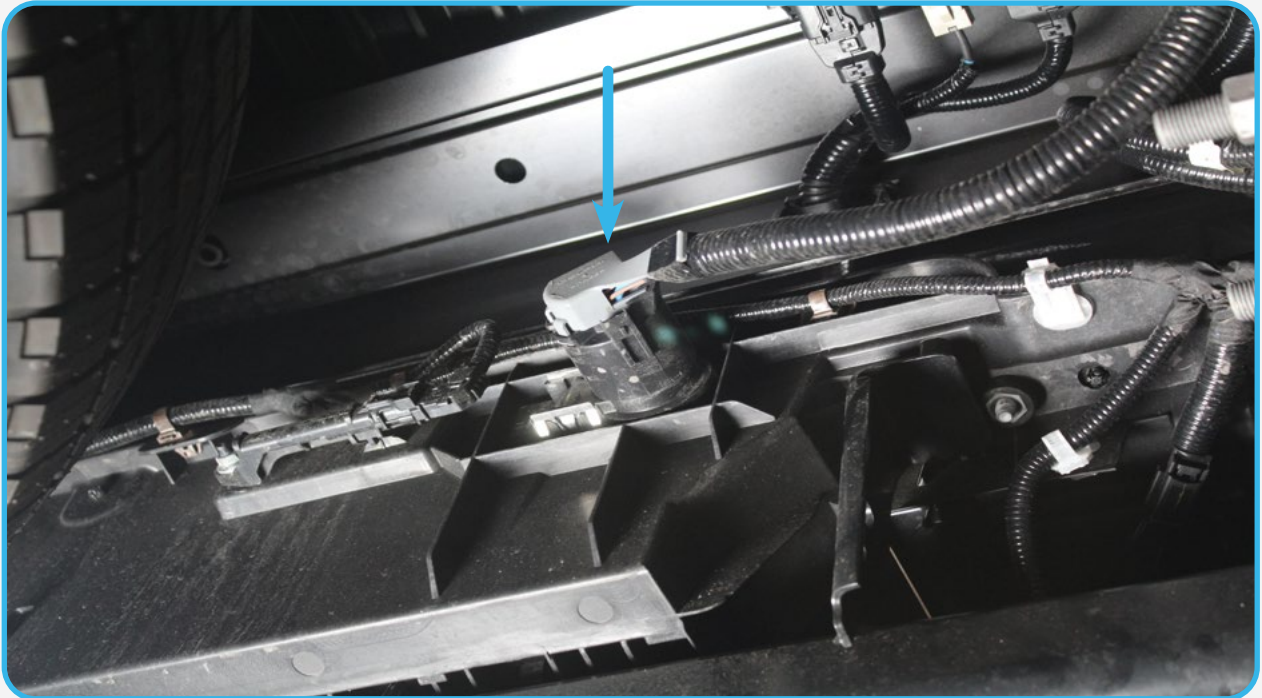

□ STEP 2

Depress and pull all three plugs on the wiring harness located underneath the bed on the passenger side of the spare tire.



□ STEP 3

Depress and pull all three plugs on the wiring harness located underneath the bed on the passenger side of the spare tire.



□ STEP 4

Carefully release rear corner panels with (trim removal tool). (Repeat on other side) ****Do not fully remove corner panels****



□ STEP 5

Unplug blind spot sensors to free the harness. Depress the tab to unplug the sensor and remove the wire loom clip located on the arrow. (Repeat on other side)

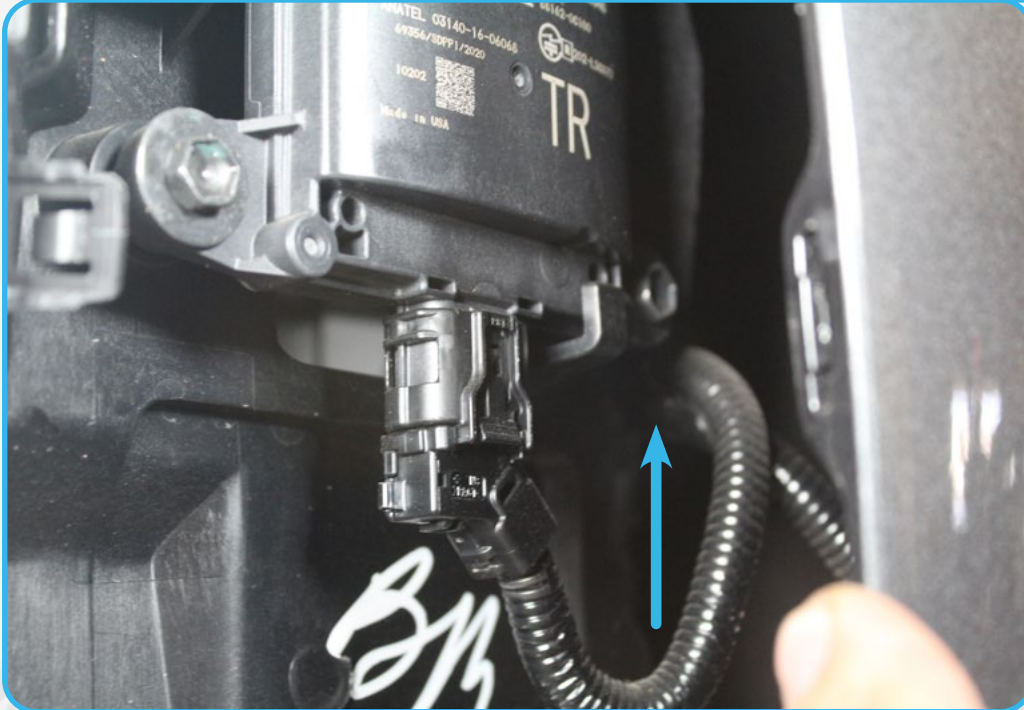
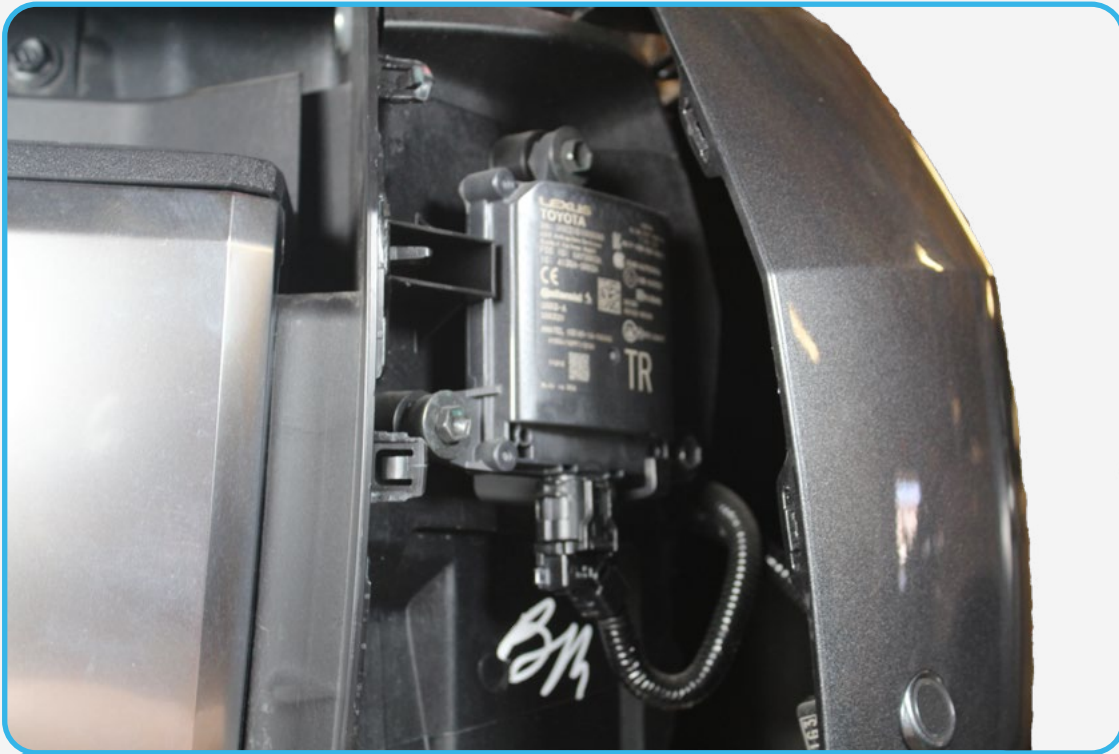

□ STEP 6

Release parking sensors from bezel. (Repeat on other side) ****DO NOT pry tabs hard due to breakage****

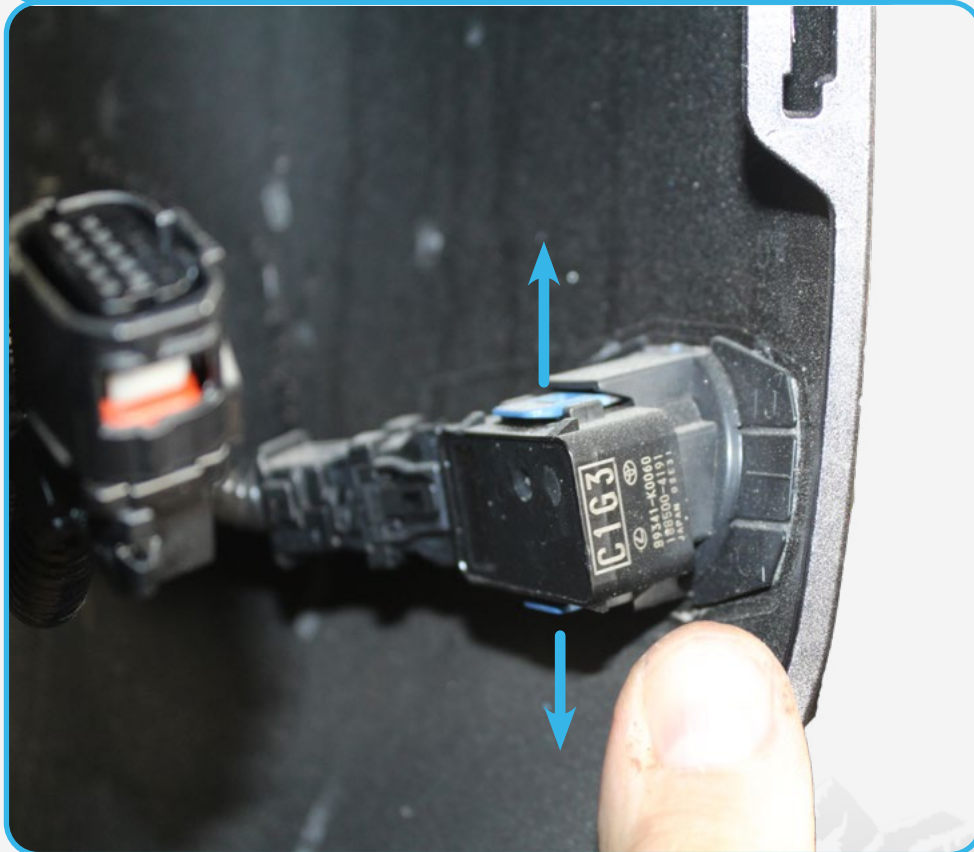

□ STEP 7

Remove the wire loom clip using (needle nose pliers) to free the harness from the body. (Repeat on other side)



□ STEP 8

Use a (7/8 wrench and 7/8 socket) to remove the hitch bolts. ****This will release the hitch, be sure to have a second hand**** ****Keep OEM hardware as they will be reused later in install****



STEP 9

Hitch and bumper will come off together.



STEP 10

Depress tab and pull to release license plate light plug.

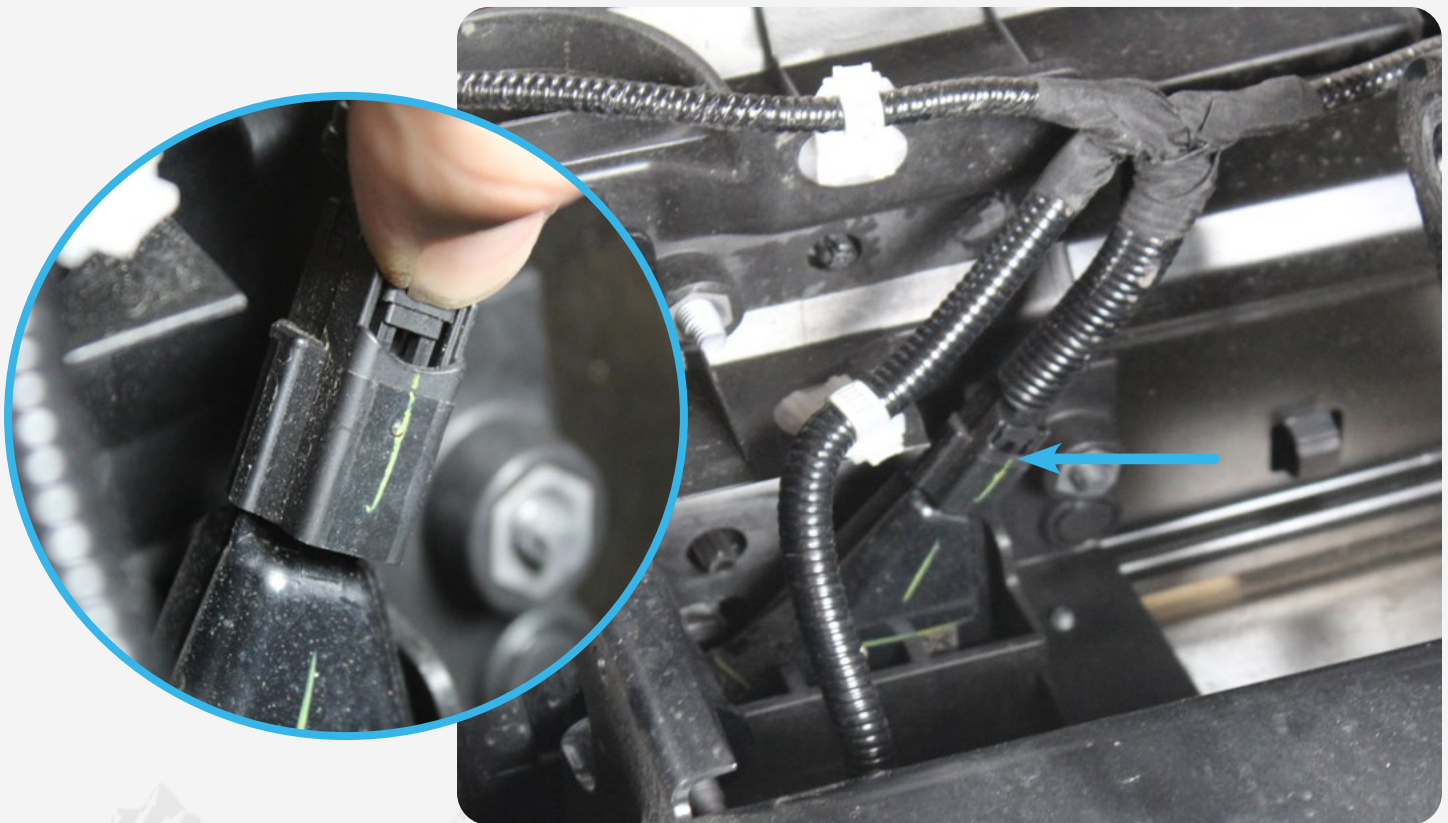

STEP 11

Using a (3/8 socket) remove the key less entry antenna.



□ STEP 12

Release parking sensors from bezel. (Repeat on other side) ****DO NOT pry tabs hard due to breakage****

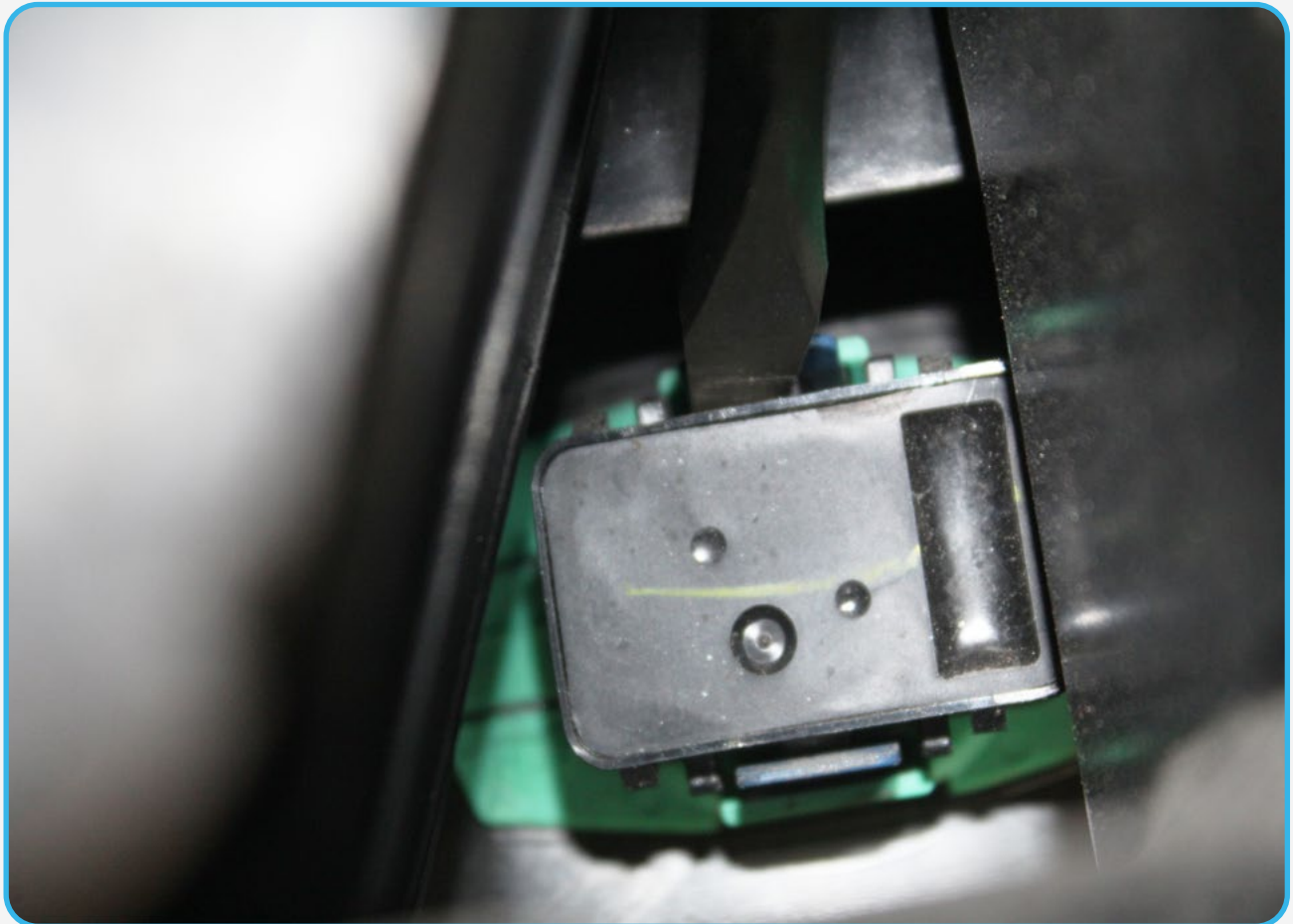

□ STEP 13

Remove all wiring loom clips with **(needle nose pliers)** from the stock bumper.

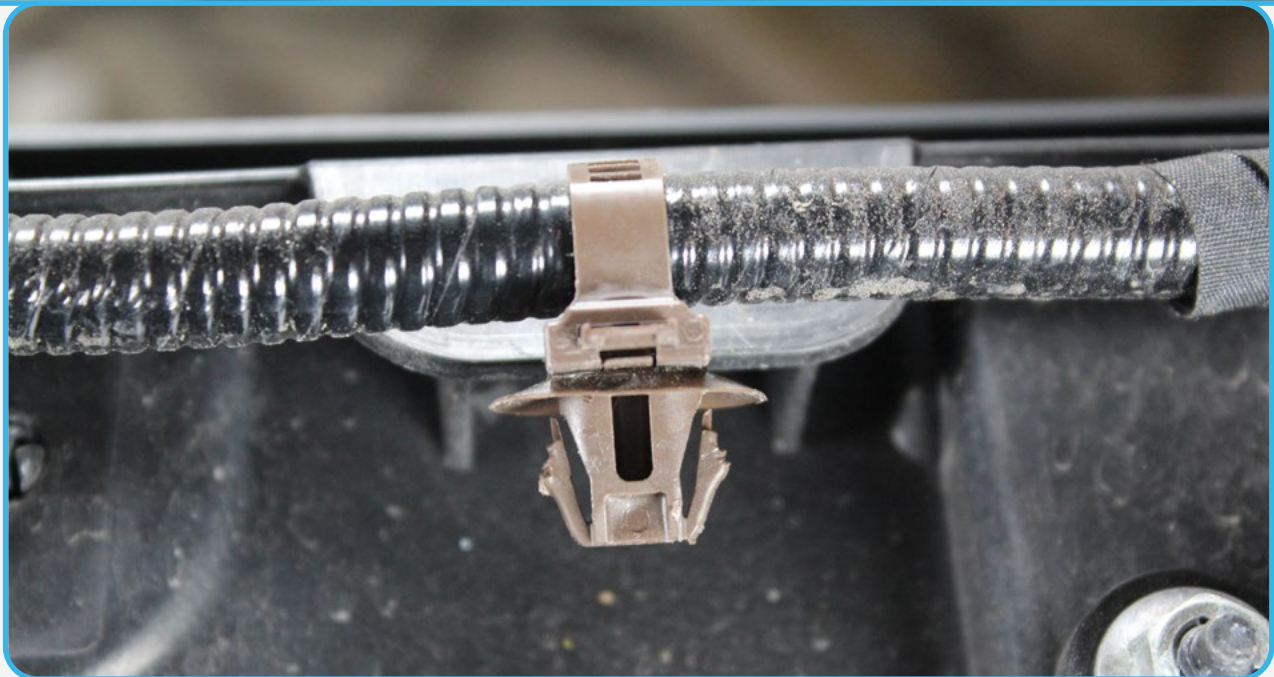

STEP 14

Set wiring harness aside. ****Remember the orientation of the harness for this will be important for install****



PASSENGER

DRIVER

□ STEP 15

Using your (trim removal tool) remove plastic caps on both sides.





□ STEP 16

Remove top plastic panels by using a (fastener remover/flathead). (repeat on other side)

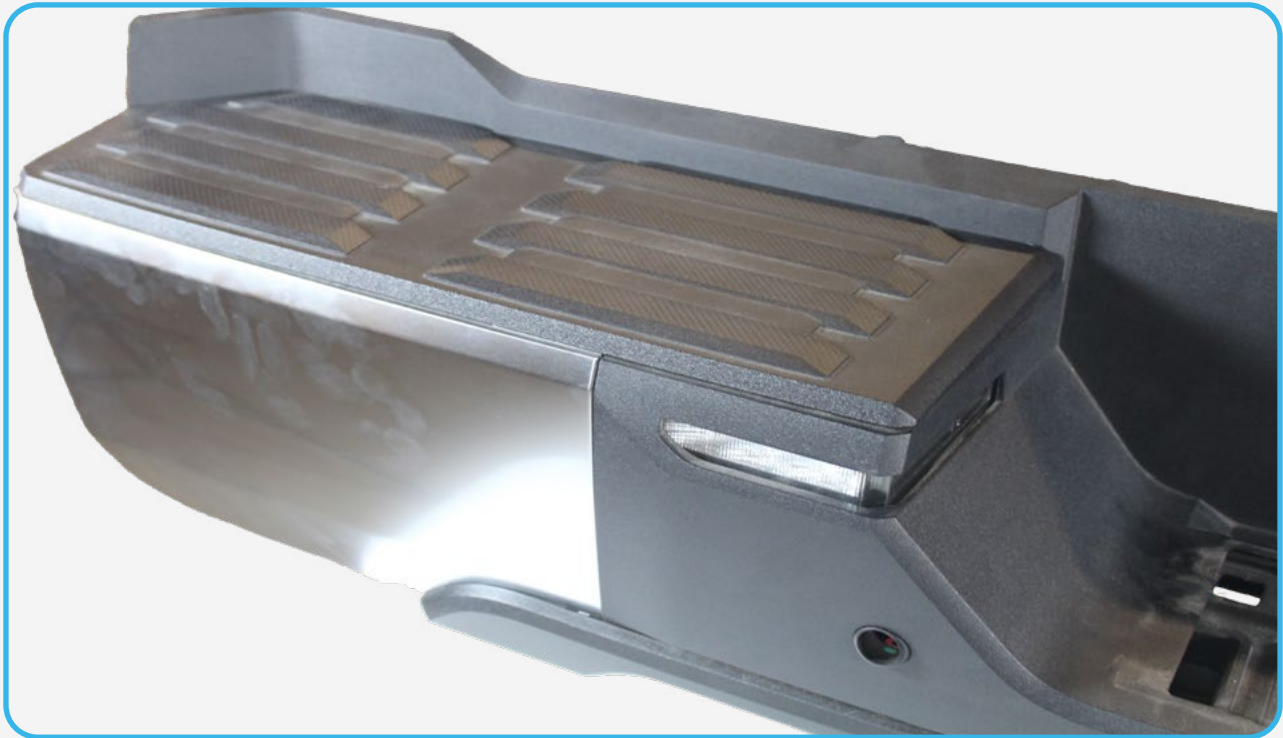

□ STEP 17

Use your (fastener remover/flathead) to remove retainer clips. (Repeat on other side)



STEP 18

Remove retainer clip with (fastener remover/flathead screwdriver).



□ STEP 19

Remove retainer clips with (fastener remover/flathead screwdriver) and use a (5/16 socket) to remove bolts from the bottom of the hitch.

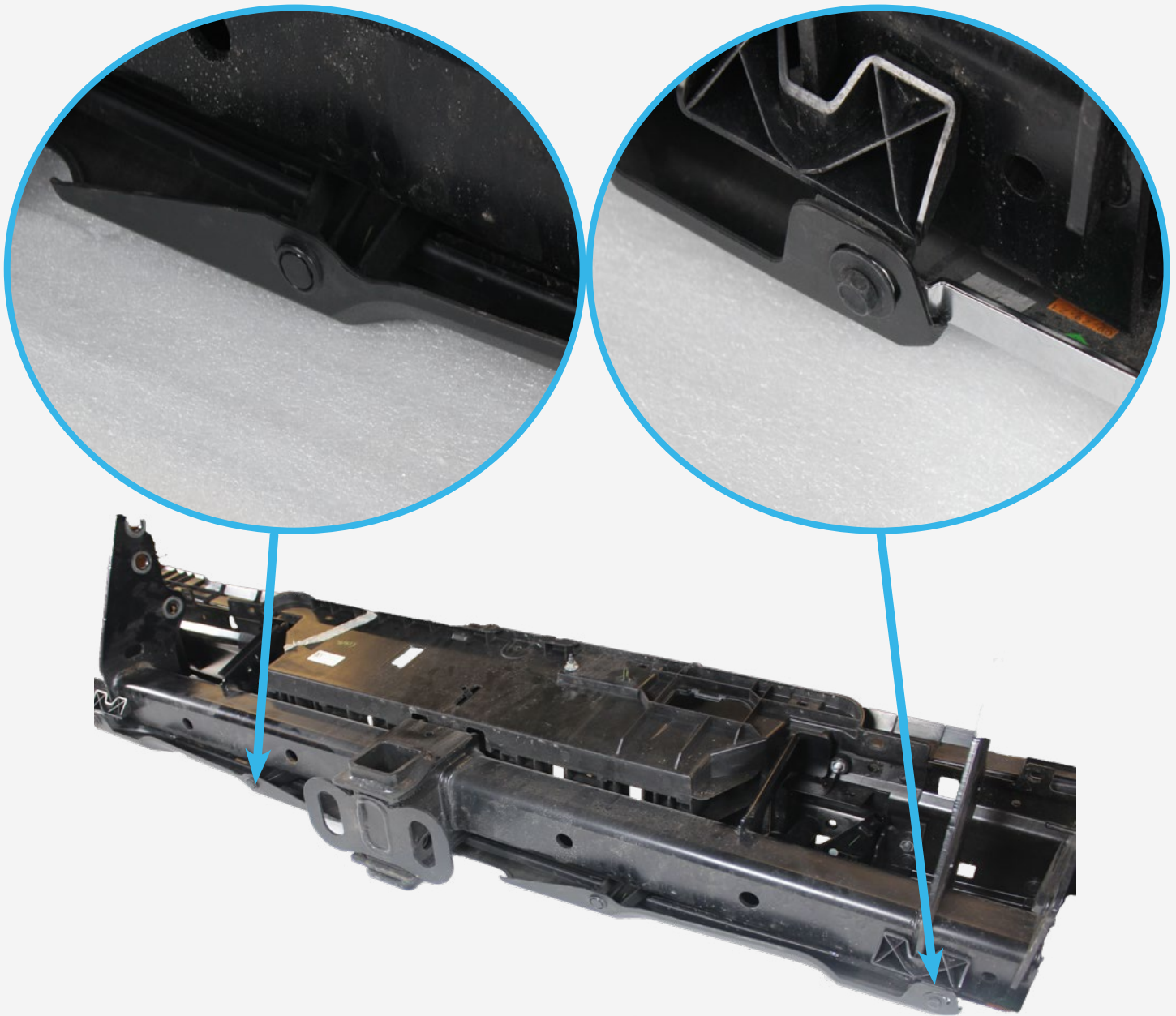

STEP 20

You can now completely remove top plastic from the hitch.



□ STEP 21

Use your (**fastener remover/flathead screwdriver**) to remove the retainer clips from underneath bumper. (Repeat on other side)

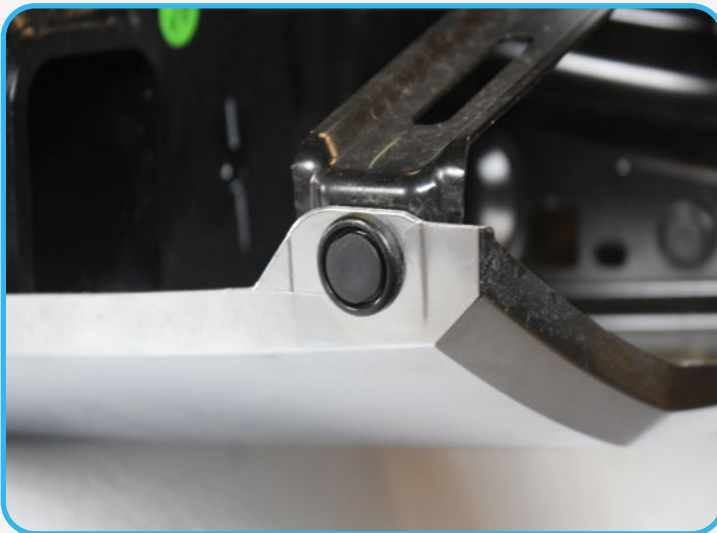

□ STEP 22

Use a (1/2 socket) to remove the bolts on top and middle of the bumper to release plastic from hitch.



□ STEP 23

Remove the retaining clips using a (fastener remover/flathead screwdriver) from underneath the bumper.



□ STEP 24

Using a (8mm socket/Philips head screwdriver) remove the screws for license plate light. (Repeat on other side)

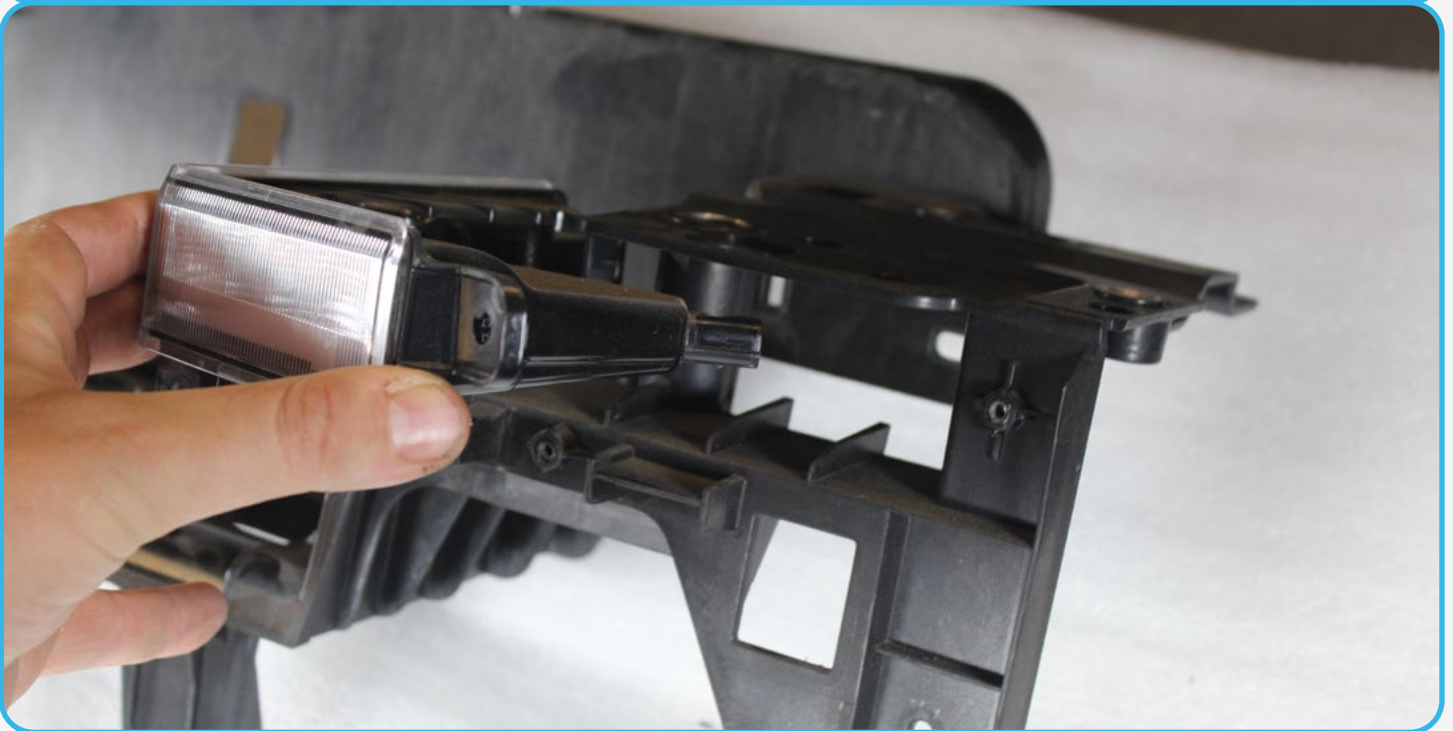
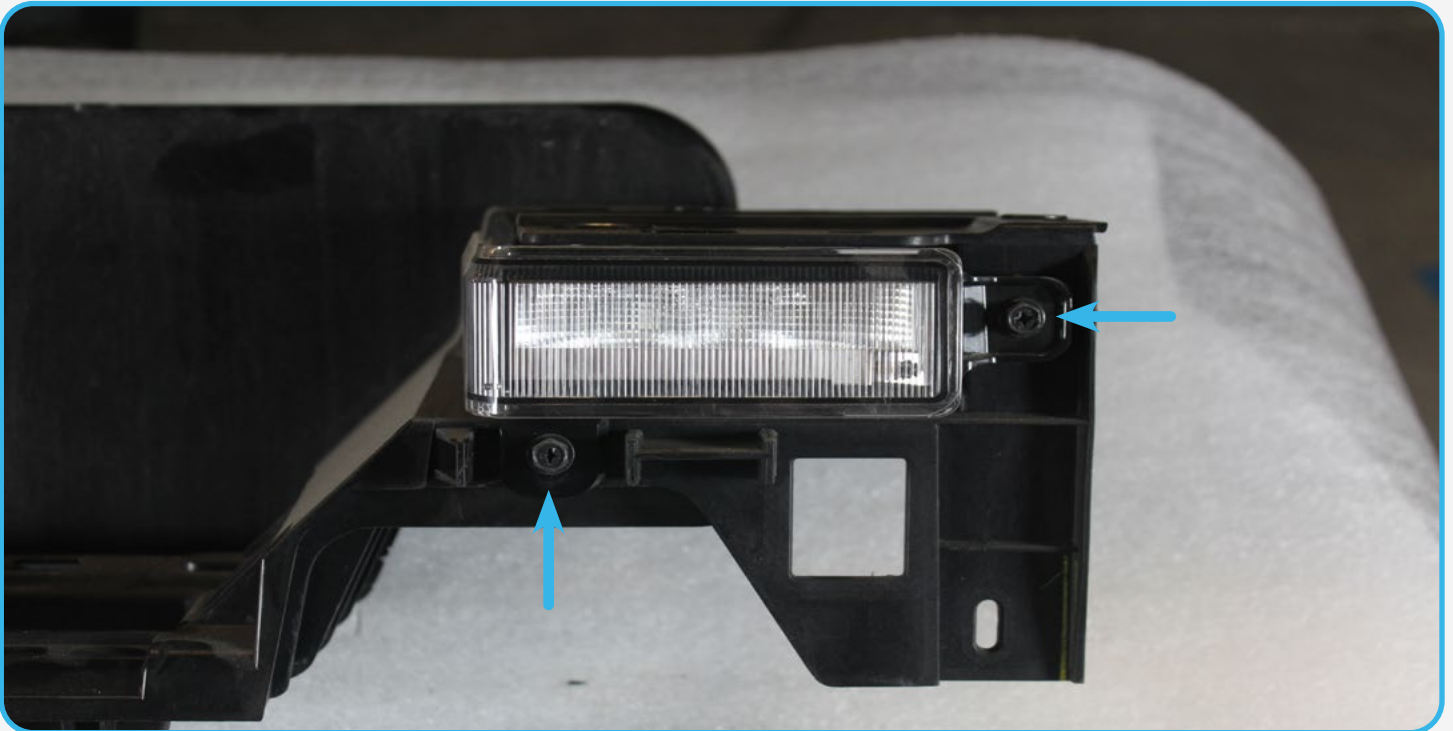

□ STEP 25

Using a (flathead screwdriver) remove the sensor bezels. ****Be careful not to break tabs on top****

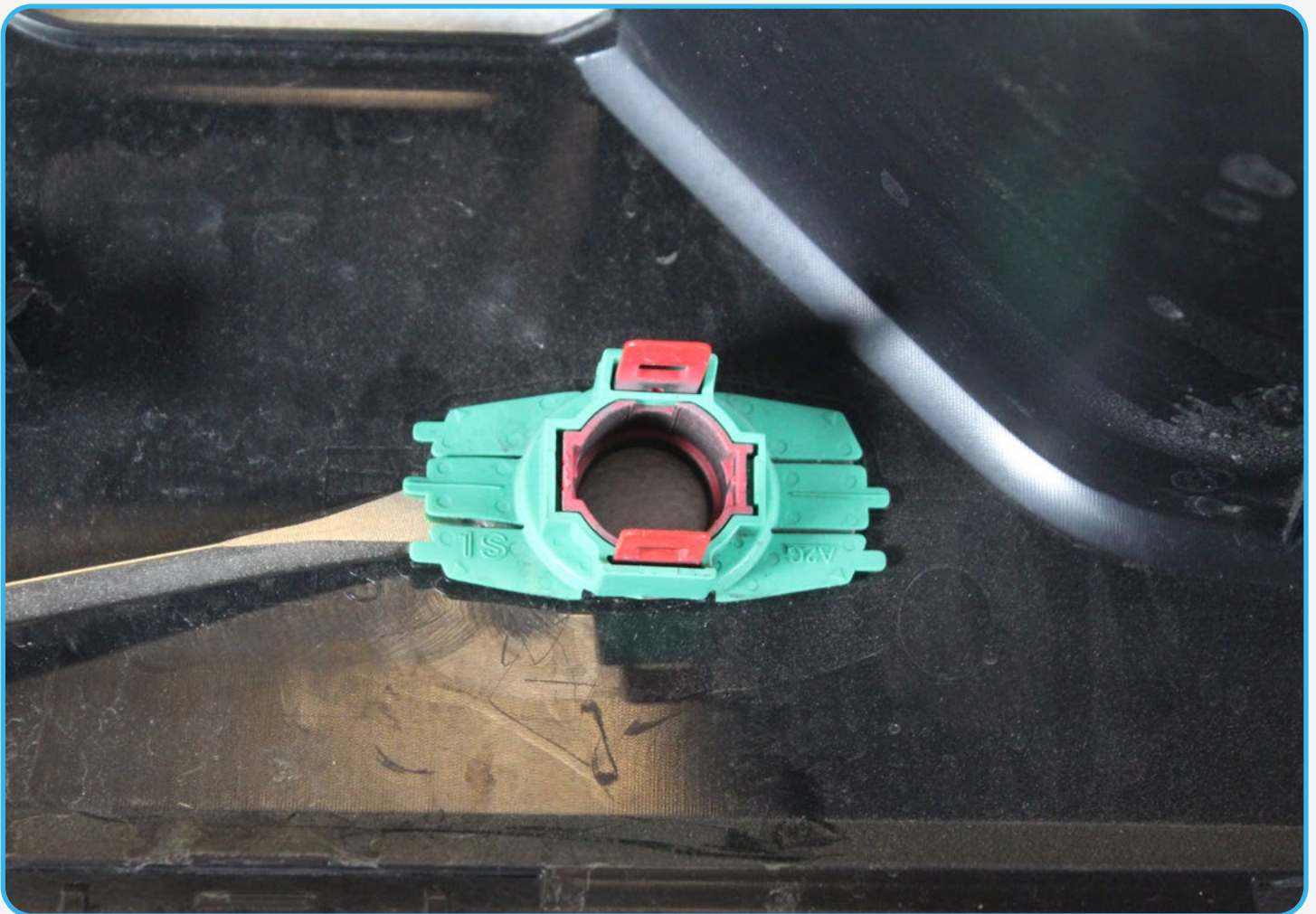
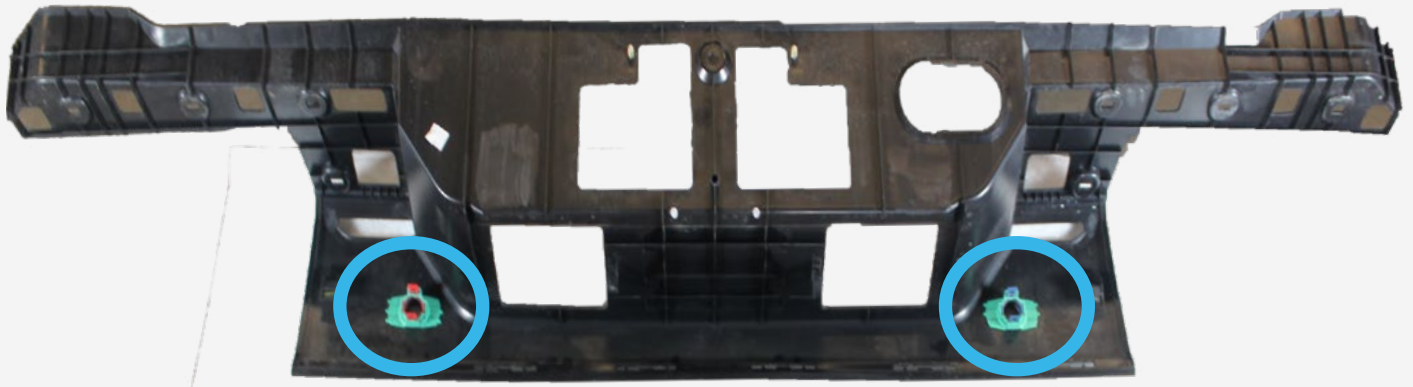

□ STEP 26

With your choice of cutting tools, cut the brackets off the hitch as shown below.



□ STEP 27

With your choice of cutting tools, cut the brackets off the hitch as shown below.

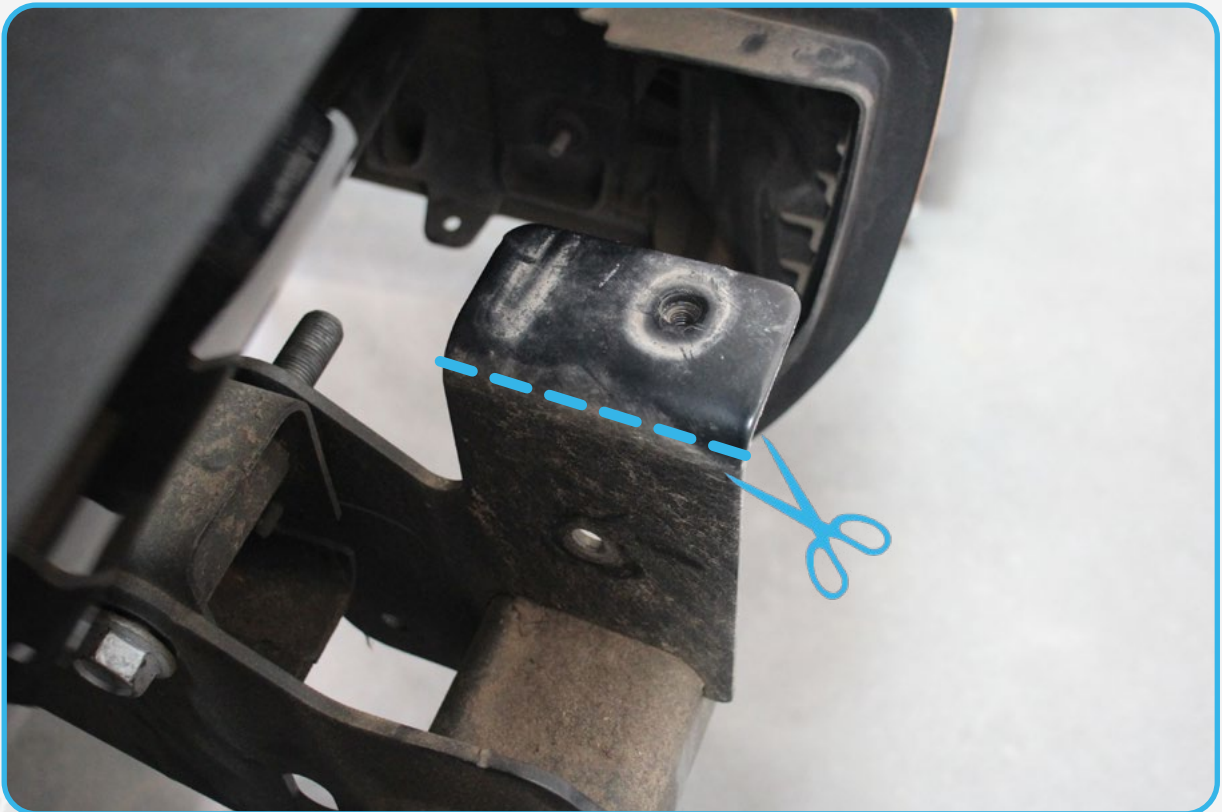

STEP 28

Install hitch. Use pins on hitch to line up correctly.

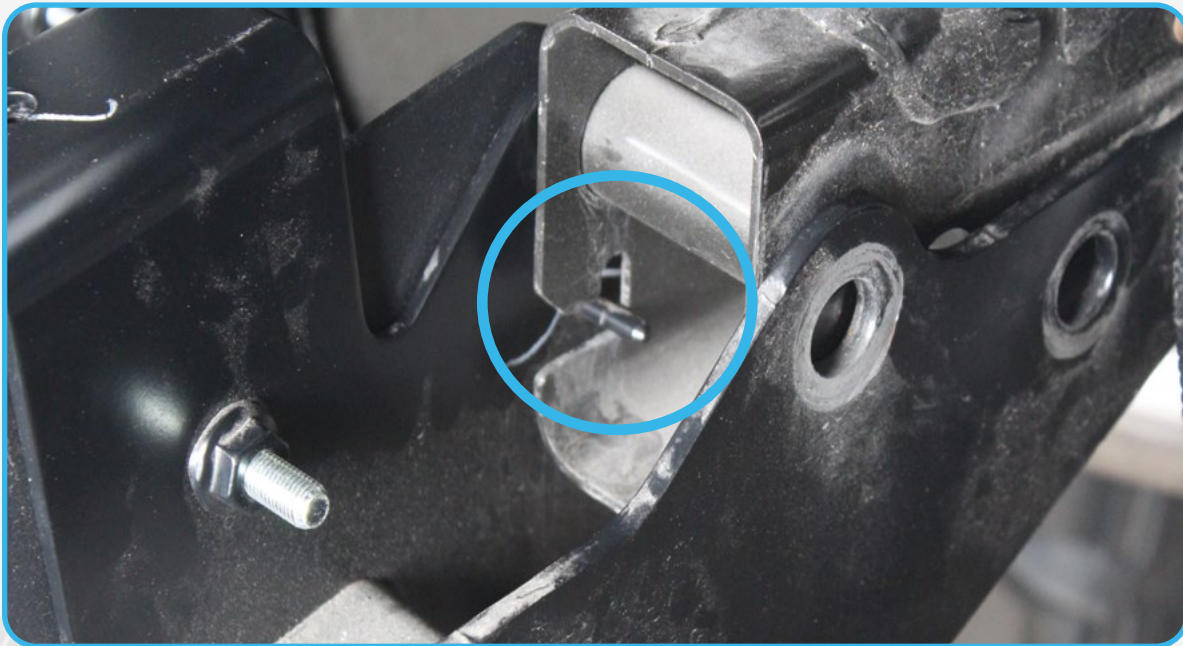

□ STEP 29

Using a (7/8 wrench and socket), install OEM hitch hardware that was removed in **step 8**. Follow the orientation provided in pictures. **Ensure that the one highlighted below does not get installed for later in the install.** (Repeat on other side)

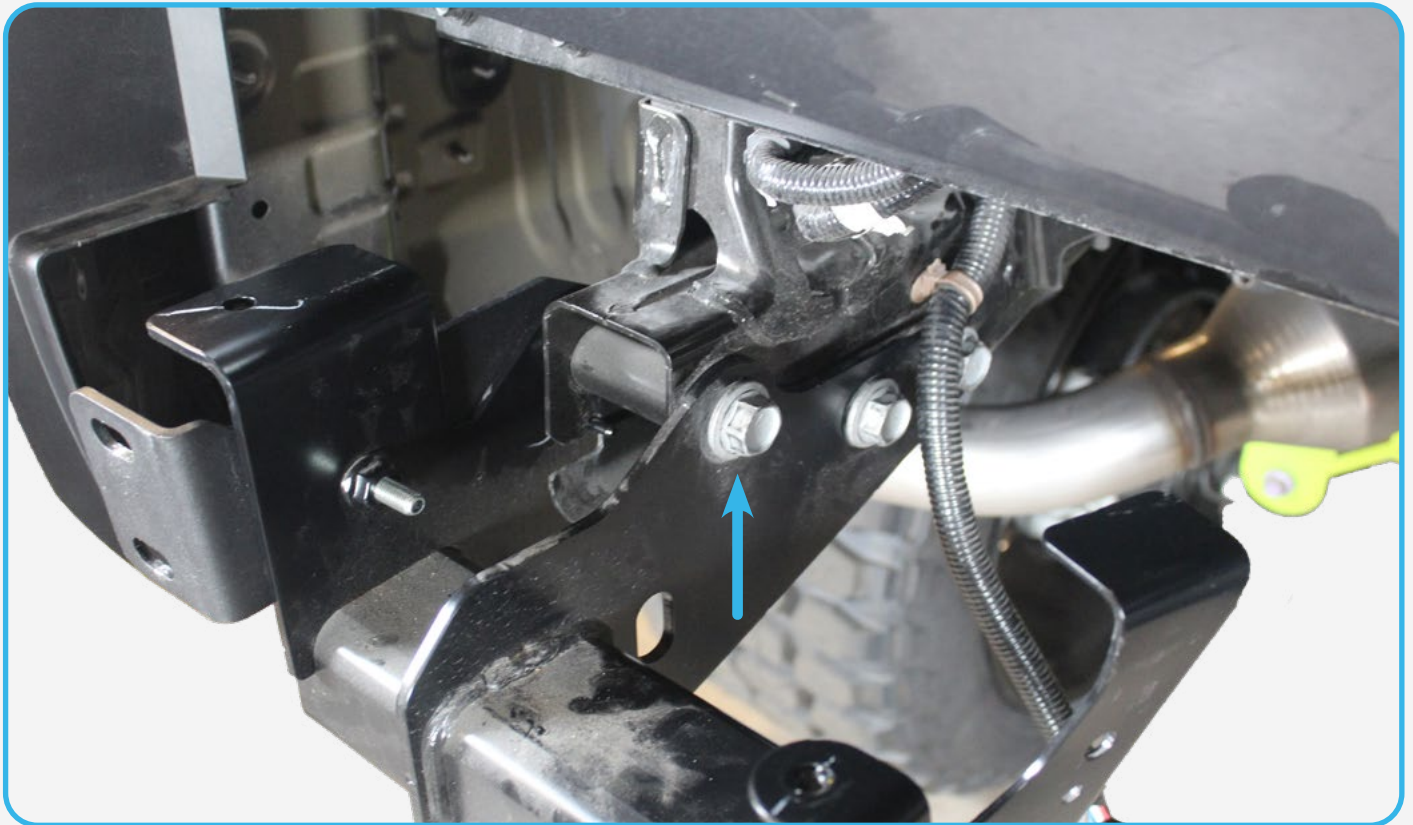

□ STEP 30

Install the mounting plates (picture below is driver side) with the hardware you left out on step 29 but **ensure to flip the bolt with the nut on the inside of the hitch** and install the provided **(B, B1)** M10 bolt and washer on driver side using a **(11/16 socket)**. On **passenger side** install the provided **(C, C1, C2)** 3/8 hardware using a **(9/16 socket)** and a **(9/16 wrench)**.

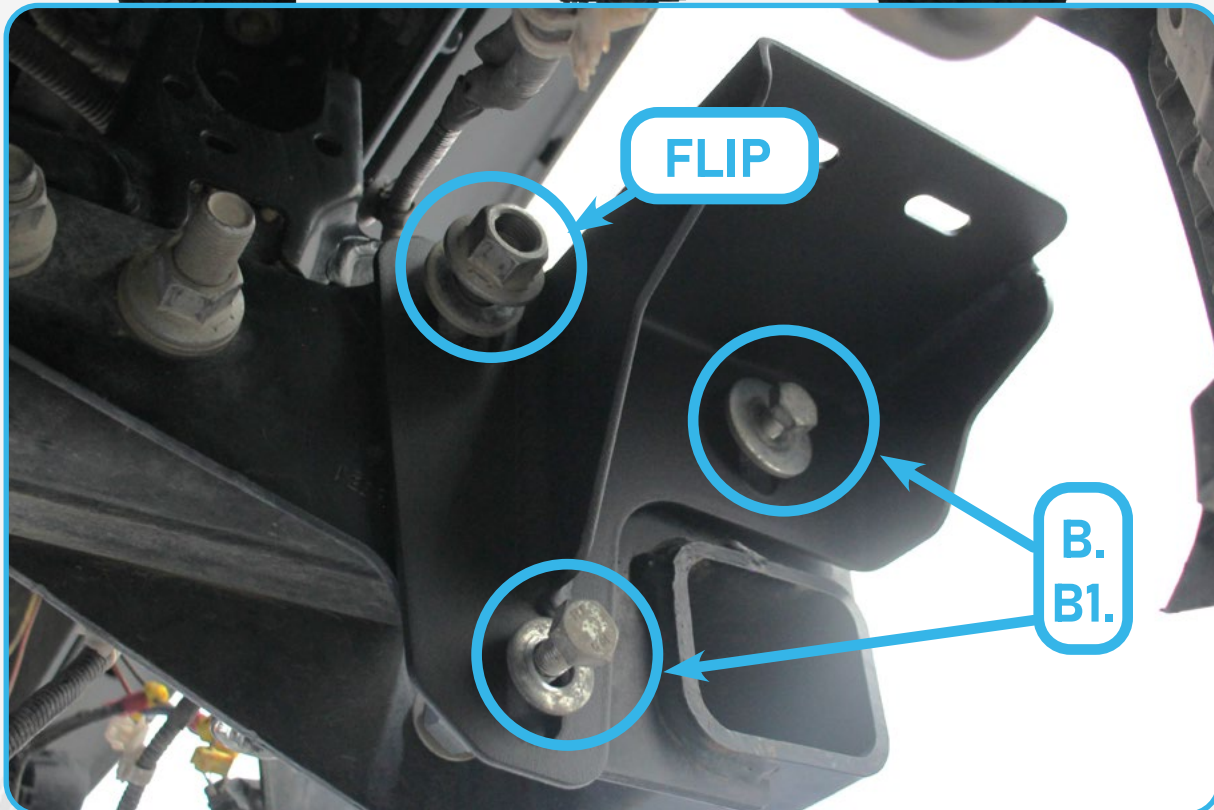

STEP 31

Remove double sided tape from the bezel until the surface is clear of residue.

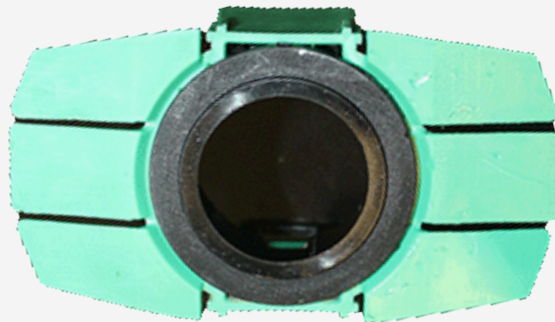

□ STEP 32

Install the provided (F) 3m double sided tape to each side of the bezel wings and trim excess with a (razor blade).

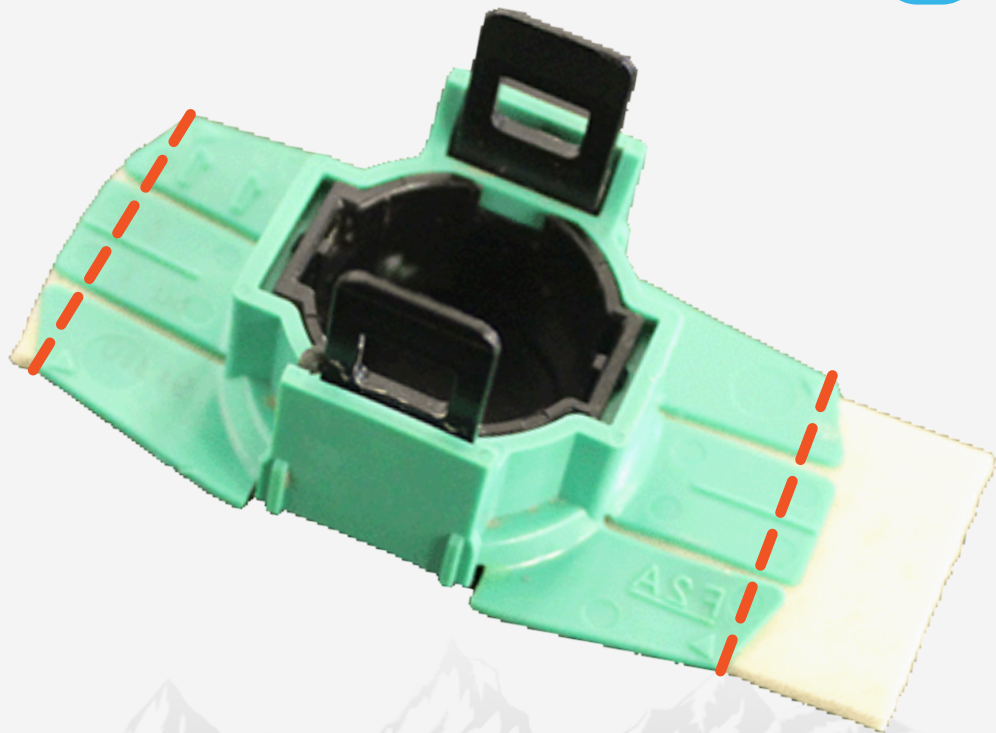
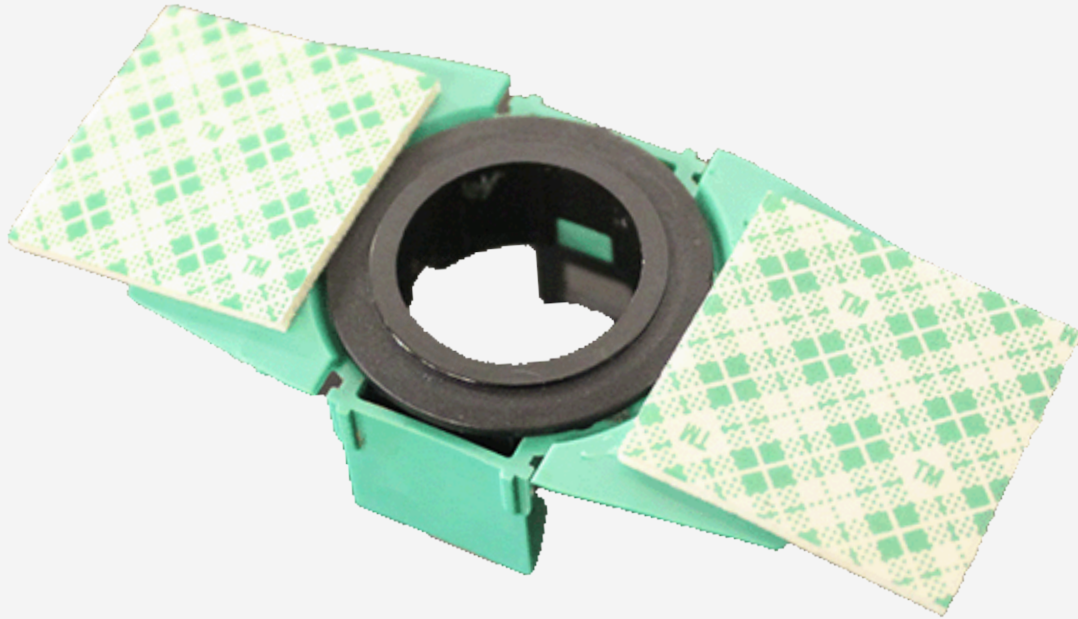

□ STEP 33

Install the bezels in the correct orientation as shown below. ****TAPE TAKES UP TO 72 HOURS TO CURE. PRO TIP: Using a heat gun, warm up the tape on the bezels and also the location where the bezels will be installed. Ensure the bumper surface is clean before installing****

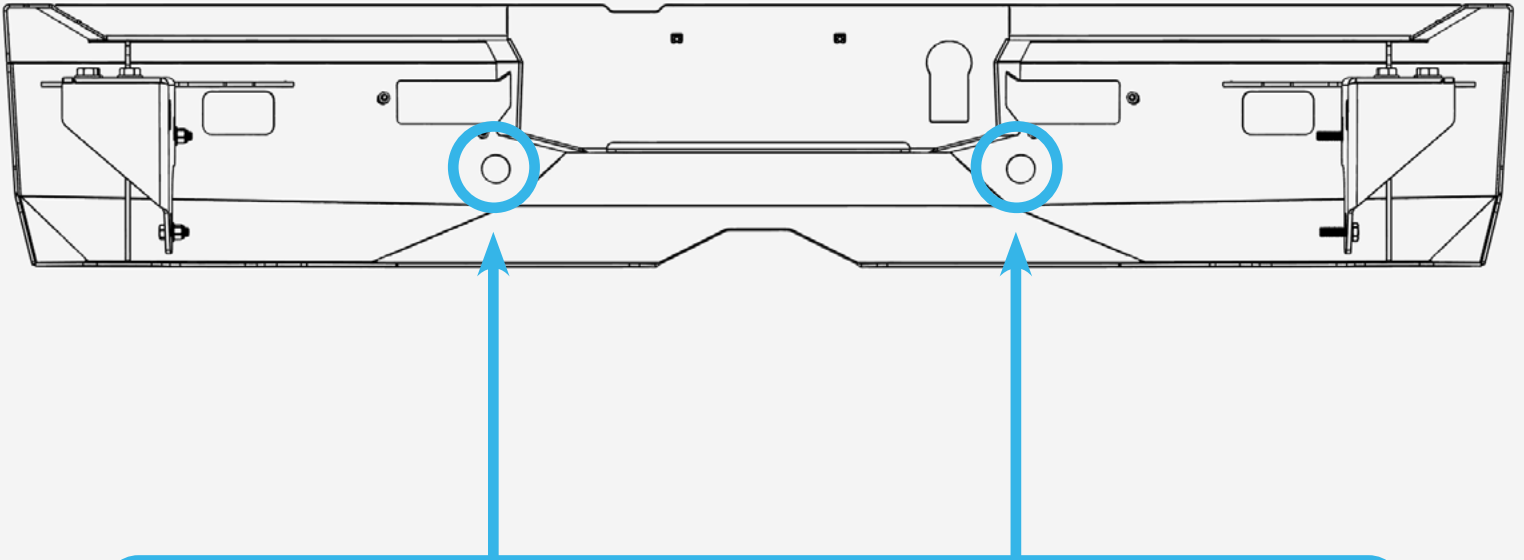

□ STEP 34

If the sensors are smaller than the cutout on the bumper, install the supplied (G) isolator grommet around the sensor to cover the gap.

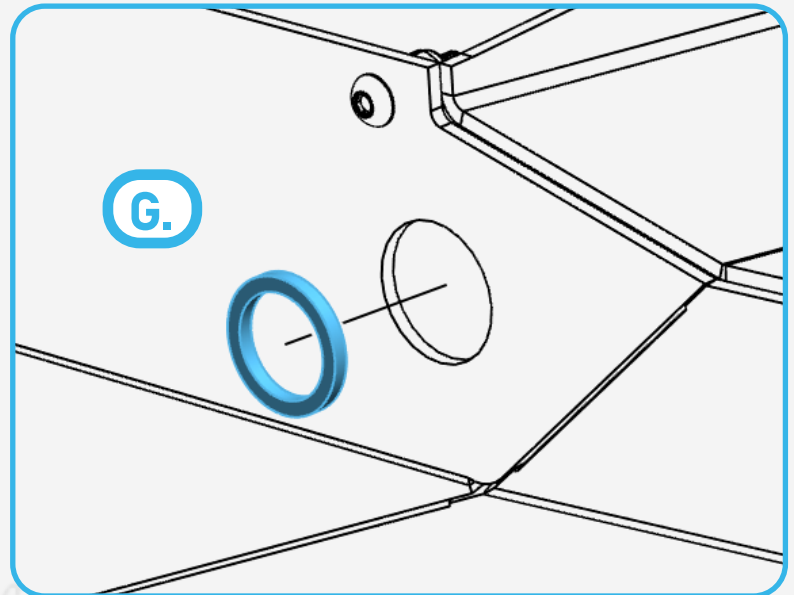
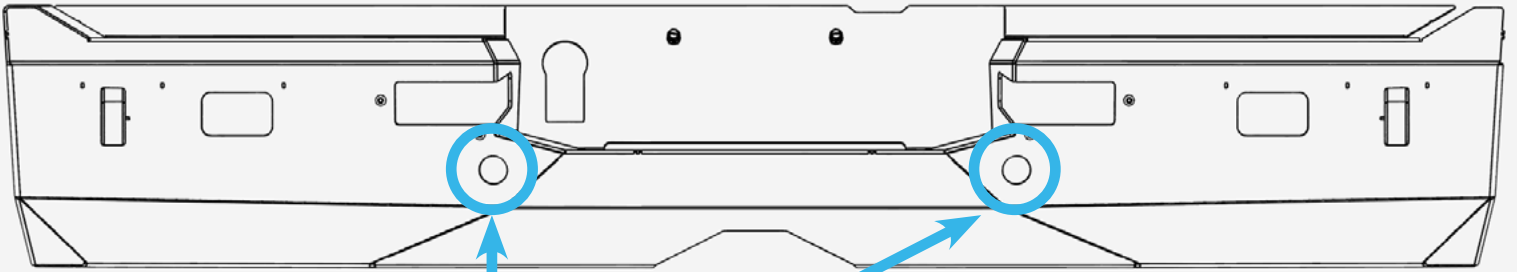

□ STEP 35

Install trailer plug and pry out the tabs to securely seat plug (flathead screwdriver).

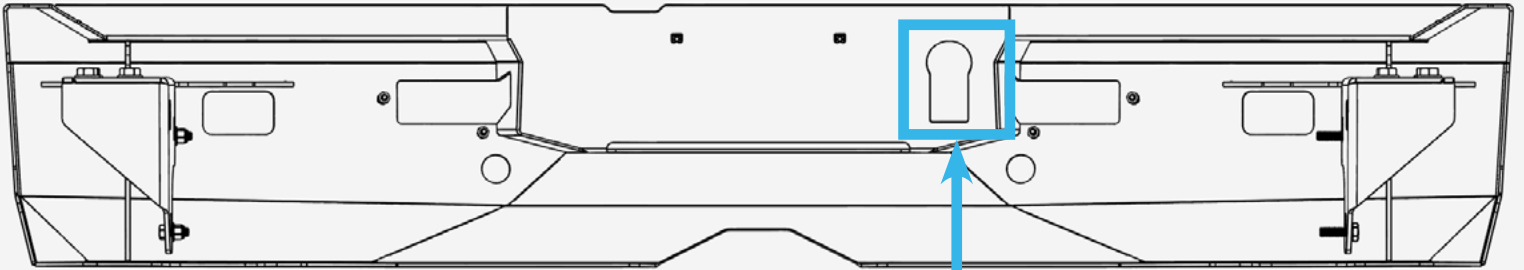

□ STEP 36

Install the license plate lights as shown below with the provided (C, B, D, D1) 1/4 hardware and the provided (C1, B, D, D1) 1/4 hardware using a (5/32 allen) and a (7/16 wrench).

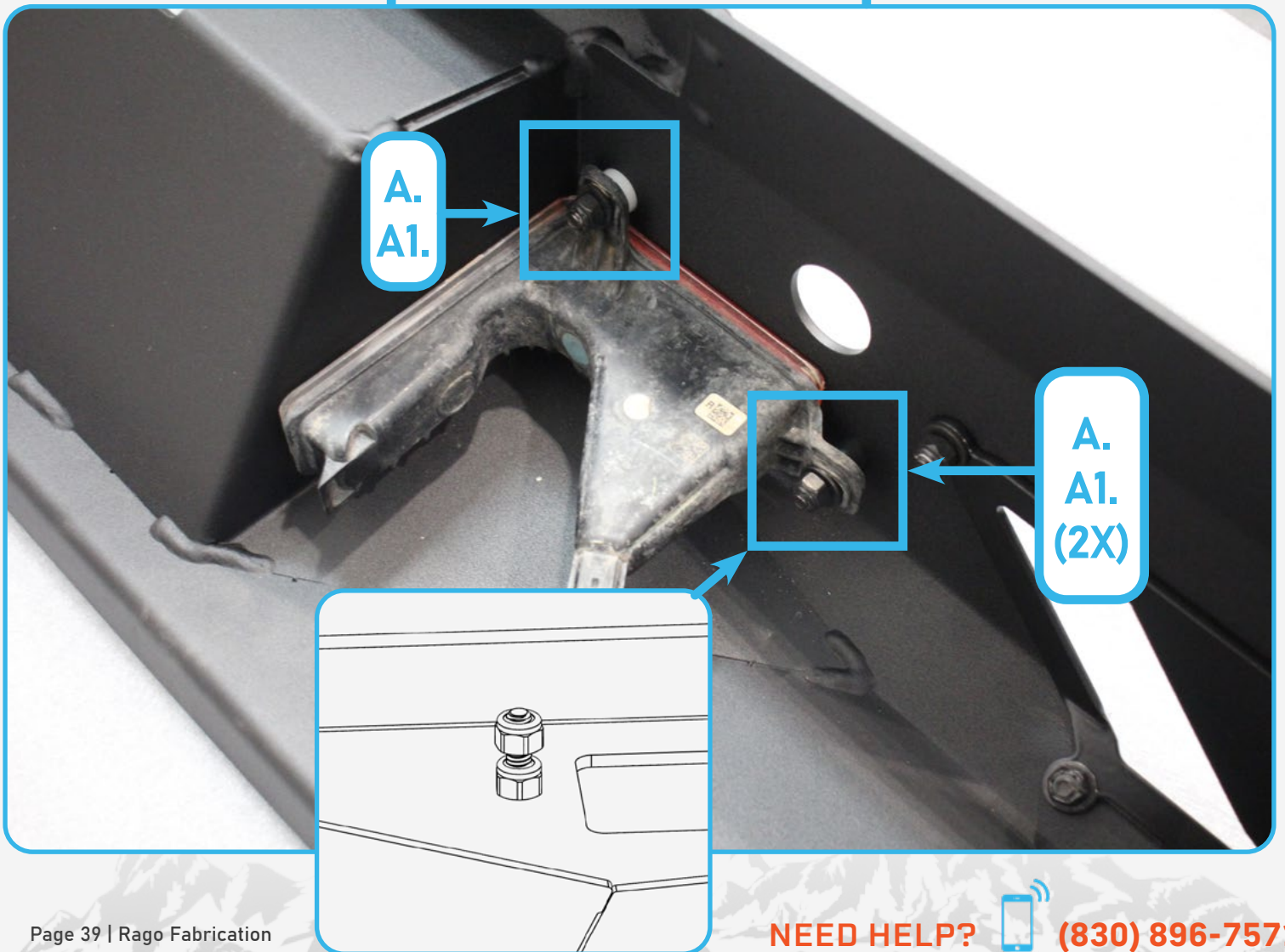
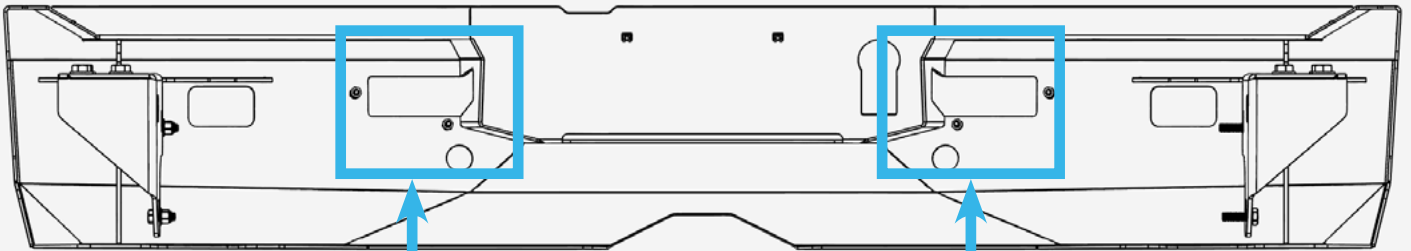

□ STEP 37

With a helping hand, install the rear bumper with the bumper going underneath the mounting bracket as shown below with the provided (D, D1, D2) 1/2" hardware using a (3/4 wrench and socket). If you are not happy with the fitment, loosen all hardware and adjust to the desired position.

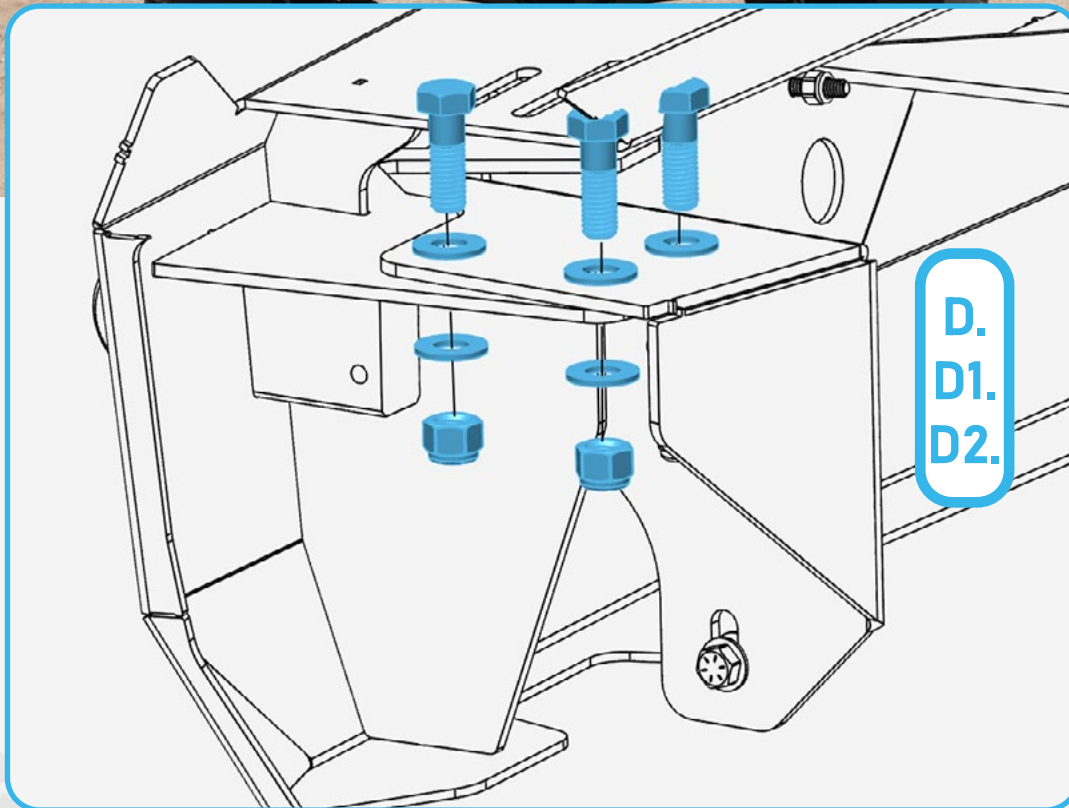
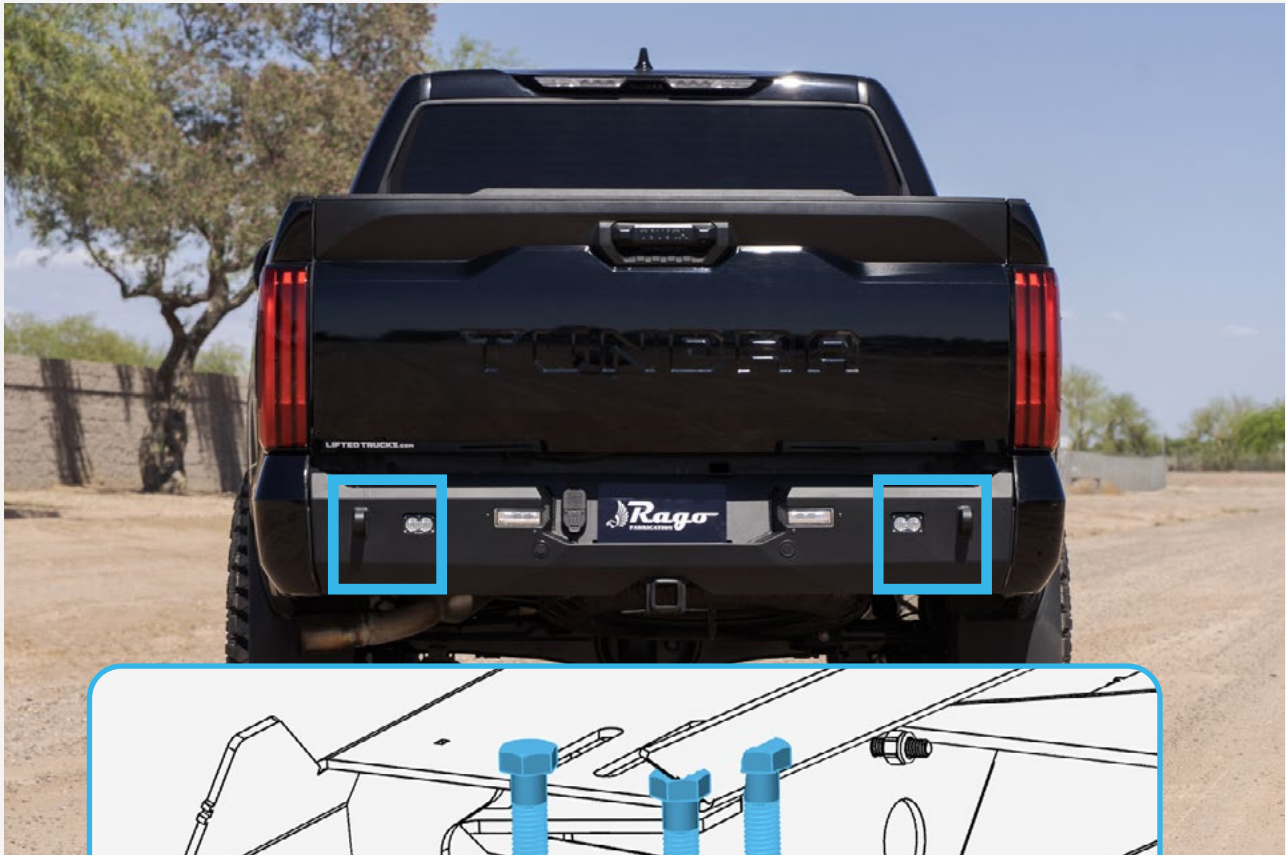

□ STEP 38

Install the license plate with the provided (E, E1) hardware using a (8mm socket).

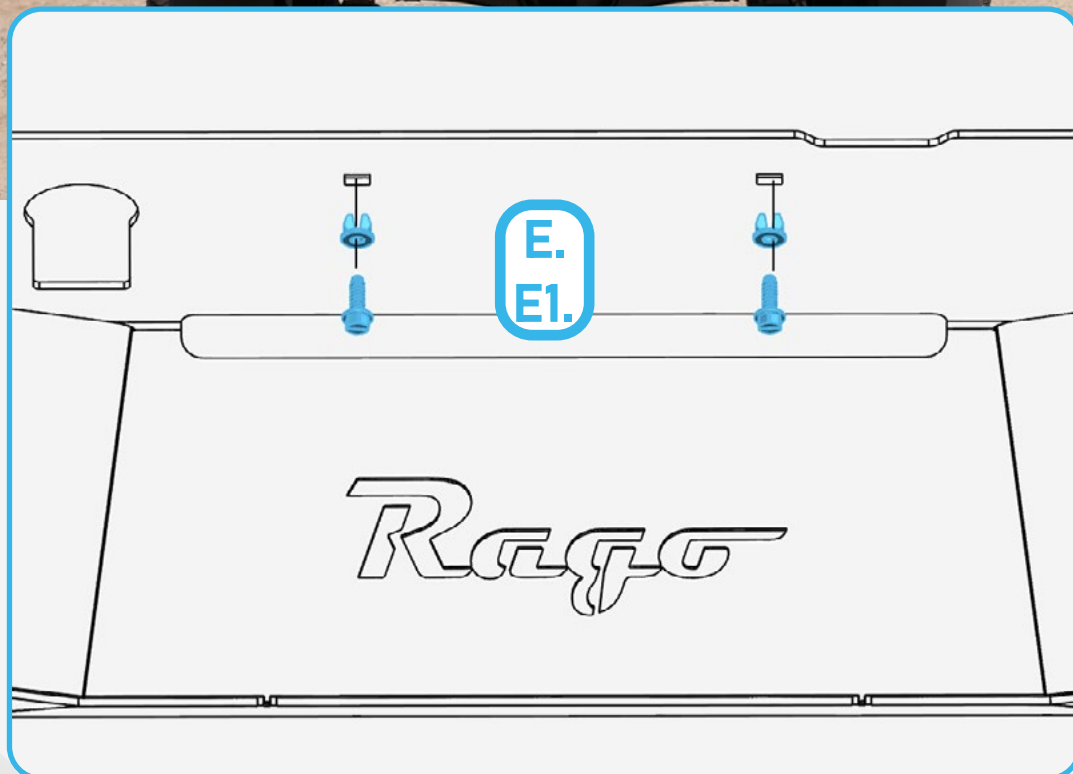

□ STEP 39

Plug the blind spot sensor and your parking sensor back in and clip side panel back in and install your push pins from **step 3**.





□ STEP 40

Plug the wiring harness back into the three plugs located on the passenger side of the spare tire.

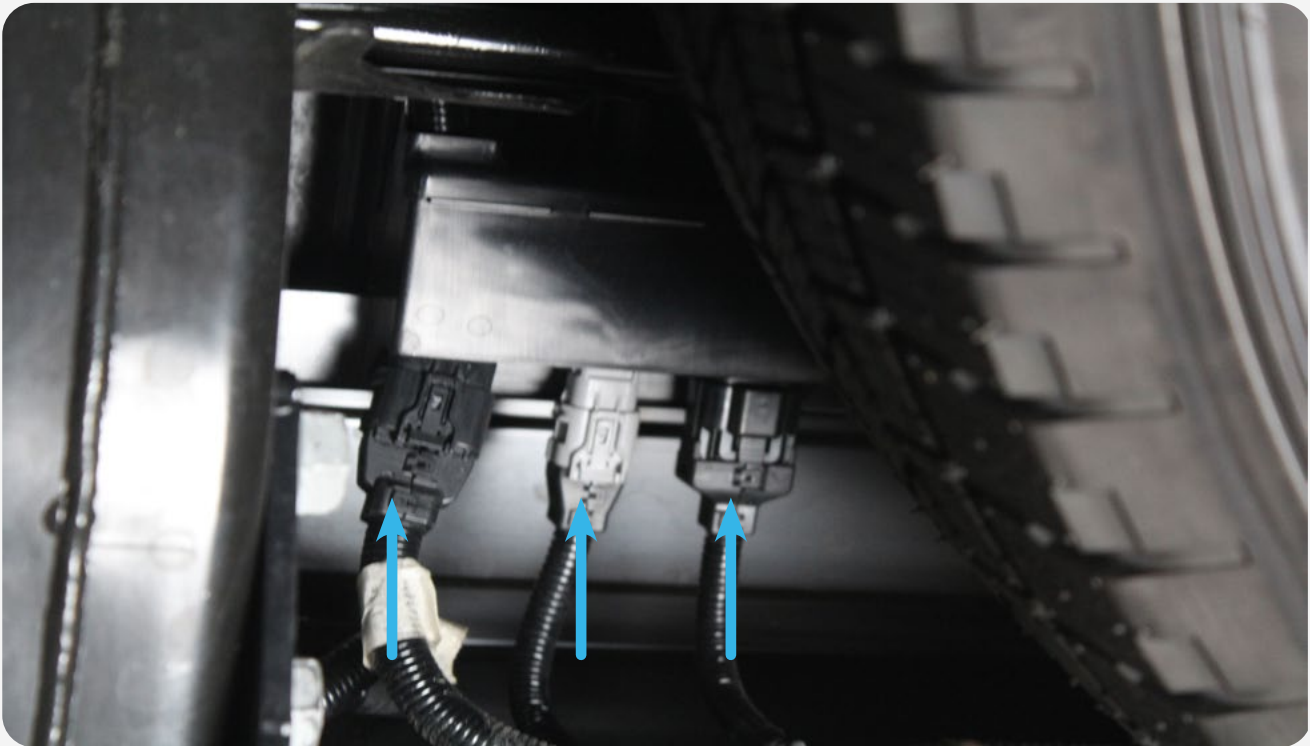

STEP 41

Remove wire loom clip for the trailer plug in to reach. Plug back in.

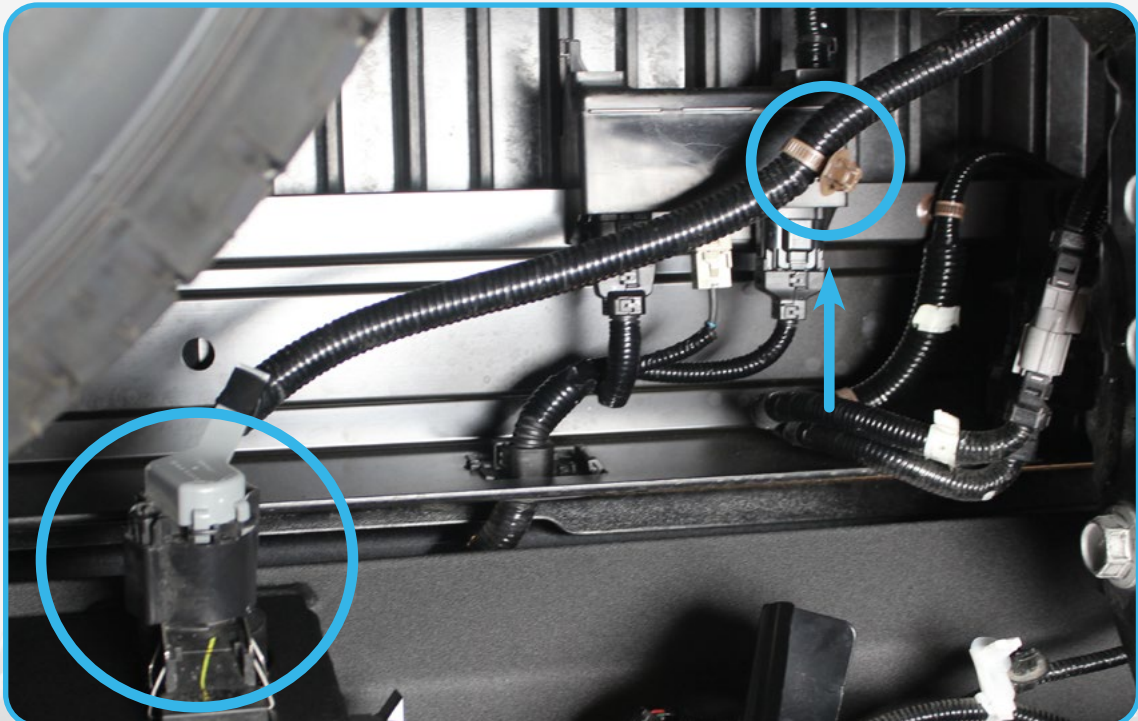
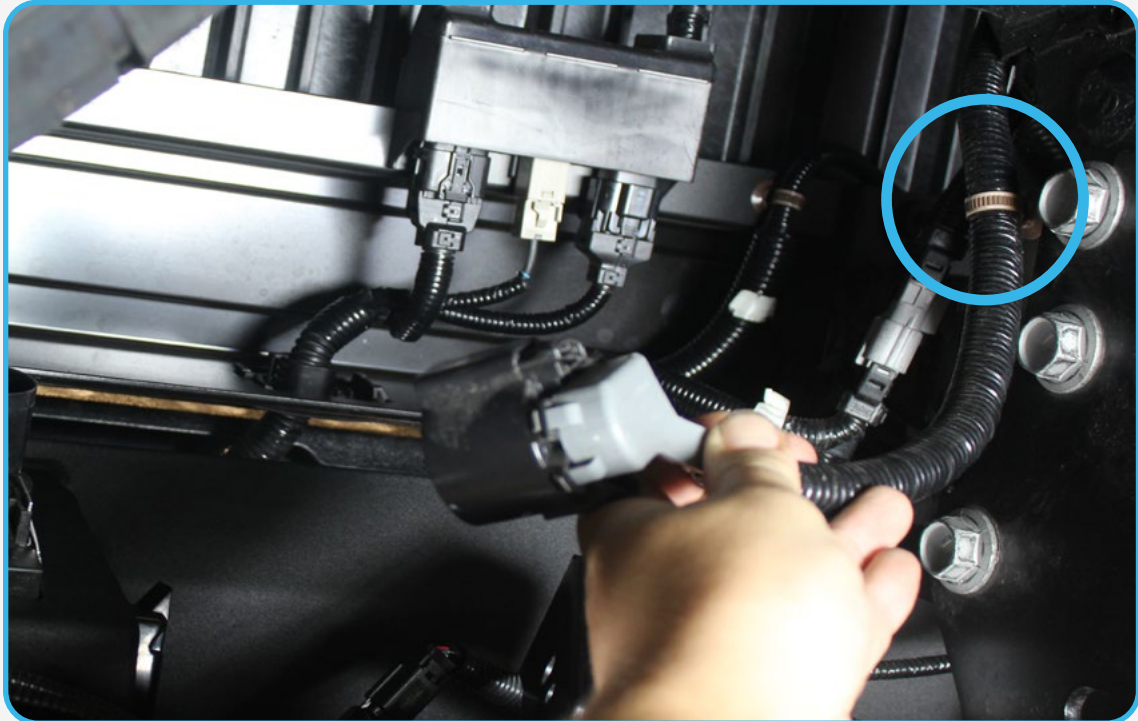

STEP 42

Stand back and enjoy your new RAGO Rear Bumper.

Check and re-tighten all mounting bolts after 100 miles and periodically thereafter.

