

7929 Lincoln Ave. Riverside, CA 92504
 Phone: 951.689.ICON | Fax: 951.689.1016

PART #	DESCRIPTION
52050	TOYOTA REAR 8.0" U-BOLT KIT

COMPONENTS INCLUDED	
N/A	
HARDWARE INCLUDED	
(4) 159689 8.0" SQ TOP UBOLT 9/16-18 W/NUTS /WASHERS/TACO/TUNDRA/COLORADO	
TOOLS REQUIRED	
JACK JACK STANDS TORQUE WRENCH	7/8" SOCKET / WRENCH 19MM SOCKET / WRENCH
TECH NOTES	
N/A	

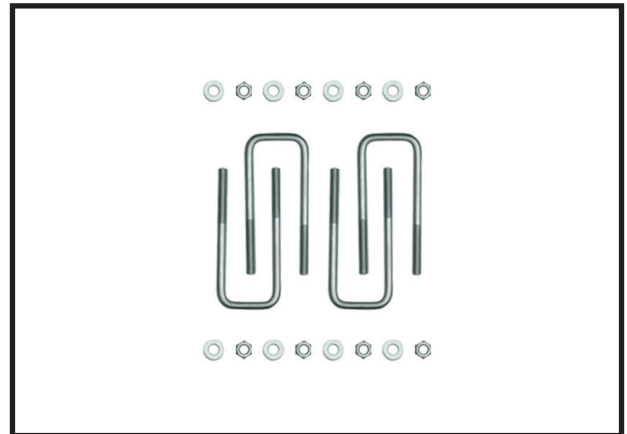

WARNING!
<p>** READ ALL INSTRUCTIONS THOROUGHLY FROM START TO FINISH BEFORE BEGINNING INSTALLATION! IF THESE INSTRUCTIONS ARE NOT PROPERLY FOLLOWED SEVERE FRAME, SUSPENSION AND TIRE DAMAGE MAY RESULT TO THE VEHICLE!</p> <p>** ICON VEHICLE DYNAMICS RECOMMENDS THAT YOU EXERCISE EXTREME CAUTION WHEN WORKING UNDER A VEHICLE THAT IS SUPPORTED WITH JACK STANDS.</p> <p>** ICON VEHICLE DYNAMICS RECOMMENDS ALL INSTALLATION TO BE PERFORMED BY A PROFESSIONAL SHOP/SERVICE TECHNICIAN. PRODUCT FAILURE CAUSED BY IMPROPER INSTALLATION WILL NOT BE COVERED UNDER ICON'S WARRANTY POLICY.</p>

INSTALLATION

- Using a properly rated jack, raise the rear of the vehicle and support the frame rails with jack stands. Ensure the jack stands are secure and set properly before lowering the jack. NEVER WORK UNDER AN UNSUPPORTED VEHICLE. Remove the rear wheels.
- Remove the lower rear shock bolts using a 19mm socket/wrench.
- Use a jack to support the axle then loosen and remove the driver side U-bolts using a 19mm socket/wrench. Make sure the axle is well supported or it could fall when the U-bolts are removed.
- Slowly lower the axle away from the springs. Make desired changes to leaf spring. Refer to leaf spring install instructions.
- Use a jack to raise the axle and guide the spring center pin into the hole on the top of the axle. Install supplied U-bolts washers and nuts using a 7/8" socket/wrench. [Torque to 90ft-lbs]
- Repeat steps 2-5 on opposite side of the vehicle.
- Reinstall shock to the factory lower shock mount using a 19mm socket/wrench. [Torque to factory spec]
- Reinstall wheels and lower to the ground. [Torque to factory spec]

VERIFY ALL FASTENERS ARE PROPERLY TORQUED BEFORE DRIVING VEHICLE.

RETORQUE ALL NUTS, BOLTS AND LUGS AFTER 100 MILES AND PERIODICALLY THEREAFTER.

ICON VEHICLE DYNAMICS LIMITED LIFETIME WARRANTY

ICON Vehicle Dynamics warrants to the original retail purchaser who owns the vehicle on which the product was originally installed. ICON Vehicle Dynamics does not warrant the product for finish, alterations, modifications and/or installation contrary to ICON Vehicle Dynamics instructions. ICON Vehicle Dynamics products are not designed, nor are they intended to be installed on vehicles used in race applications, for racing purposes or for similar activities. (A "race" is defined as any contest between two or more vehicles, or a contest of one or more vehicles against the clock, whether or not such contest is for a prize). This warranty does not include coverage for police or taxi vehicles, race vehicles, or vehicles used for government or commercial purposes. Also excluded from this warranty are sales outside of the United States of America and Canada.

ICON Vehicle Dynamics' obligation under this warranty is limited to the repair or replacement, at ICON Vehicle Dynamics' discretion, of the defective product. Any and all costs of removal, installation or re-installation, freight charges and incidental or consequential damages are expressly excluded from this warranty. Items that are subject to wear are not considered defective when worn and are not covered.

ICON Vehicle Dynamics components must be installed as a complete kit as shown in our current application guide. Any substitutions or exemptions of required components will immediately void the warranty. Some finish damage may happen to parts during shipping and is not covered under warranty.

This warranty is expressly in lieu of all other warranties expressed or implied. This warranty shall not apply to any product that has been improperly installed, modified or customized subject to accident, negligence, abuse or misuse.



ICON VEHICLE DYNAMICS®
PERFORMANCE SUSPENSION SYSTEMS AND SHOCK ABSORBERS

7929 Lincoln Ave. Riverside, CA 92504 Phone: 951.689.ICON Fax: 951.689.1016
www.iconvehicledynamics.com



FOLLOW US ON FACEBOOK!



7929 Lincoln Ave. Riverside, CA 92504
 Phone: 951.689.ICON Fax: 951.689.1016

PART #	DESCRIPTION
56108	07-UP TUNDRA REAR HYDRAULIC BUMP STOP SYSTEM

COMPONENTS INCLUDED	
(1) 154152 07+ TUNDRA REAR AIR BUMP (DRVR) (1) 154153 07+ TUNDRA REAR AIR BUMP (PASS) (2) 154154 07+ TUNDRA STRIKER PLATE	(2) 204908 2.0 AIR BUMP 2.5" TRAVEL 1:1 RATIO (1) 56108H REAR AIR BUMP HARDWARE KIT
HARDWARE INCLUDED	
56108H HARDWARE KIT	
(4) 605052 1/4-20 NYLOCK NUT (4) 605057 1/4-20 X 2.00 BOLT (8) 605202 7/16-14 X 1.250 BOLT	(8) 695220 7/16-14 LOCK NUT (16) 605230 7/16 FLAT WASHER (1) 605969 VIBRATITE RED 2ML BULLET (2) 605970 VIBRATITE ANTI-SEIZE TUBE
TOOLS REQUIRED	
JACK JACK STANDS GRINDER W/ CUT-OFF WHEEL AIR CHISEL HAMMER	DRIFT PUNCH 19MM SOCKET / WRENCH 7/16" SOCKET / WRENCH 5/8" SOCKET / WRENCH TORQUE WRENCH
TECH NOTES	
<p>1. APPLY ANTI-SEIZE TO THE BUMP STOP CYLINDER BEFORE INSERTING INTO THE BRACKET. FAILURE TO APPLY ANTI-SEIZE MAY CAUSE BUMP STOP TO BECOME STUCK IN THE BRACKET.</p> <p>2. YOUR ICON BUMP STOP ASSEMBLIES COME FACTORY CHARGED TO 150 PSI. PLEASE CONSULT ICON PRIOR TO MAKING ANY NITROGEN PRESSURE CHANGES.</p>	



WARNING!

**** READ ALL INSTRUCTIONS THOROUGHLY FROM START TO FINISH BEFORE BEGINNING INSTALLATION! IF THESE INSTRUCTIONS ARE NOT PROPERLY FOLLOWED SEVERE FRAME, SUSPENSION AND TIRE DAMAGE MAY RESULT TO THE VEHICLE!**

**** ICON VEHICLE DYNAMICS RECOMMENDS THAT YOU EXERCISE EXTREME CAUTION WHEN WORKING UNDER A VEHICLE THAT IS SUPPORTED WITH JACK STANDS.**

**** ICON VEHICLE DYNAMICS RECOMMENDS ALL INSTALLATION TO BE PERFORMED BY A PROFESSIONAL SHOP/SERVICE TECHNICIAN. PRODUCT FAILURE CAUSED BY IMPROPER INSTALLATION WILL NOT BE COVERED UNDER ICON'S WARRANTY POLICY.**

INSTALLATION

- Using a properly rated jack, raise the rear of the vehicle and support the frame rails with jack stands. Ensure the jack stands are secure and set properly before lowering the jack. NEVER WORK UNDER AN UNSUPPORTED VEHICLE. Remove the front wheels.
- Cut an X into the head of each rivet of the factory bump stop bracket. [FIGURE 1]

FIG.1



FIG.2



- Use an air chisel to cut the head of the rivets off. [FIGURE 2]
- Using a punch and hammer, push the remainder of the rivet through the frame.

5. Remove the old bump stop bracket. [FIGURE 3]

FIG.3

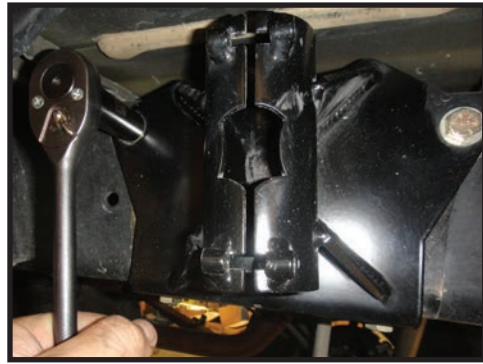

FIG.4

6. Bolt the ICON bump stop bracket to the frame using the supplied 7/16" hardware and (2) 5/8" sockets/wrenches. The brackets are labeled 'driver' and 'passenger'. [Torque to 50 ft-lbs] [FIGURE 4]

7. Apply anti-sieze to the body of the bump stop and slide it into the bump stop brackets. [FIGURE 5]

FIG.5



FIG.6

8. Use the 1/4" hardware and (2) 7/16" sockets/wrenches to clamp the bump stop in the bracket. [Torque to 8 ft-lbs] [FIGURE 6]

9. Place a floor jack under the axle and remove the U-bolts using a 19mm socket. [FIGURE 7]

FIG.7



10. Remove the factory bump stop from the top of the leaf spring and place the supplied striker plate on the spring using the center pin to locate it.

11. Reinstall the U-bolts. Push the striker plate inboard as you tighten the U-bolts. This will remove the space between the support tangs and the side of the spring pack. Torque to factory spec. [FIGURE 8 & 9]

FIG.8



FIG.9

12. Install the wheels and lower the vehicle back to the ground. [Torque to factory spec]

VERIFY ALL FASTENERS ARE PROPERLY TORQUED BEFORE DRIVING VEHICLE.

RETORQUE ALL NUTS, BOLTS AND LUGS AFTER 100 MILES AND PERIODICALLY THEREAFTER.

2.0 HYDRAULIC BUMP STOP TECHNICAL INFORMATION

MAINTENANCE

ICON shock absorbers are a high quality rebuildable race style shock absorber designed for optimal performance. With a unit of this caliber on your vehicle, routine maintenance is required to keep them looking and operating in like new condition. Residual oil and assembly lube may be present at all seal paths from the factory out of the box and is considered normal. Pooling of oil however is not acceptable at any time and one should contact the ICON dealer where purchased.

BELOW ARE GUIDELINES BASED ON HOW YOU USE YOUR VEHICLE BUT YOUR MILEAGE MAY VARY:

STREET USE:

- Send in for factory servicing every 40,000 miles or if a leak develops, ride quality decreases, or they begin to make excessive noise.
- Remove any buildup of road salt, mud, or debris from shocks anytime accrued
- Clean with mild soap and water with each oil change or anytime you notice build up.
- Wax the cylinders yearly with automotive wax to prevent corrosion.
- Check nitrogen pressure yearly.

STREET/DIRT:

- Send in for factory servicing every 15,000 miles or if a leak develops, ride quality decreases, or they begin to make excessive noise.
- Clean with mild soap and water with each oil change, offroad trip, or anytime you notice build up.
- Wax the cylinders yearly with automotive wax to prevent corrosion.
- Check nitrogen pressure each dirt outing.

DIRT USE:

- Send in for factory servicing every 1,000 miles.
- Check nitrogen pressure each outing.
- Remove any buildup of mud or debris from shocks after every outing.

SELF-SERVICE:

- Contact ICON for service kits & tools at (951) 689-4266.

PRODUCT REGISTRATION

Please visit: <http://www.iconvehicledynamics.com/tech-support/registration/> to register your product.

ICON VEHICLE DYNAMICS SHOCK ABSORBER WARRANTY

This shock absorber has a 1 year warranty against any manufacturer's defects. If a shock fails within the initial year of ownership, the shock must be shipped to ICON Vehicle Dynamics for inspection and service. If a shock is inspected and it has been determined the shock failed due to neglect, damage caused by improper installation or any other reason besides "normal wear and tear", the owner of said shock is responsible for all service costs. This includes labor, parts, and shipping.

ICON Vehicle Dynamics warrants to the original retail purchaser who owns the vehicle on which the product was originally installed. ICON Vehicle Dynamics does not warrant the product for finish, alterations, modifications and/or installation contrary to ICON Vehicle Dynamics instructions. ICON Vehicle Dynamics products are not designed, nor are they intended to be installed on vehicles used in race applications, for racing purposes or for similar activities. (A "race" is defined as any contest between two or more vehicles, or a contest of one or more vehicles against the clock, whether or not such contest is for a prize). This warranty does not include coverage for police or taxi vehicles, race vehicles, or vehicles used for government or commercial purposes. Also excluded from this warranty are sales outside of the United States of America and Canada.

ICON Vehicle Dynamics' obligation under this warranty is limited to the repair or replacement, at ICON Vehicle Dynamics' discretion, of the defective product. Any and all costs of removal, installation or re-installation, freight charges and incidental or consequential damages are expressly excluded from this warranty. Items that are subject to wear are not considered defective when worn and are not covered.

ICON Vehicle Dynamics components must be installed as a complete kit as shown in our current application guide. Any substitutions or exemptions of required components will immediately void the warranty. Some finish damage may happen to parts during shipping and is not covered under warranty.

This warranty is expressly in lieu of all other warranties expressed or implied. This warranty shall not apply to any product that has been improperly installed, modified or customized subject to accident, negligence, abuse or misuse.

To send a shock in for warranty please visit our website <http://www.iconvehicledynamics.com/tech-support/shock-service/>

ICON VEHICLE DYNAMICS

PERFORMANCE SUSPENSION SYSTEMS AND SHOCK ABSORBERS

7929 Lincoln Ave. Riverside, CA 92504 Phone: 951.689.ICON Fax: 951.689.1016
www.iconvehicledynamics.com



FOLLOW US ON FACEBOOK!



7929 Lincoln Ave. Riverside, CA 92504
 Phone: 951.689.ICON | Fax: 951.689.1016

PART #	DESCRIPTION
57823P	07-21 TUNDRA RXT REAR 2.5 VS RR PAIR

COMPONENTS INCLUDED	
(2) 154884R-AL 07-21 TUNDRA RXT REAR 2.5 AL RR UPKG (2) 250003 10" RESERVOIR MOUNTING PLATE	(2) 611008 RXT STEM BUSHING KIT (1) 611051 #36 1.188-2.750 STAINLESS HOSE CLAMP KIT (4)
HARDWARE INCLUDED	
(2) 605131 3/8" SPLIT LOCK WASHER	(2) 605144 3/8-12 X .750 SELF TAPPING BOLT
611008 RXT STEM BUSHING KIT	
(2) HEAVY DUTY 9/16" ID STEM BUSHING (2) HEAVY DUTY 9/16" ID STEM WASHER	(2) M12-1.25 JAM NUT
TOOLS REQUIRED	
JACK JACK STANDS SANDER DRILL 17/32" DRILL BIT	TORQUE WRENCH 5/16" SOCKET / WRENCH 9/16" SOCKET / WRENCH 17MM SOCKET / WRENCH 19MM SOCKET / WRENCH
TECH NOTES	
<p>1. FAILURE TO SAND LOWER SHOCK MOUNT WILL CAUSE DAMAGE TO THE RETAINING RING OF THE SHOCK.</p> <p>2. IF PLANNING TO INSTALL THE HYDRAULIC BUMP STOP KIT IN THE FUTURE, ALLOW FOR A LITTLE EXTRA HOSE SLACK WHEN MOUNTING THE SHOCK RESERVOIR.</p> <p>3. YOUR ICON SHOCK ASSEMBLIES COME FACTORY CHARGED TO 250 PSI. RELEASING NITROGEN PRESSURE MAY LEAD TO SHOCK MALFUNCTION AND REDUCED RIDE QUALITY. FAILURE CAUSED BY LOW NITROGEN PRESSURE IS NOT COVERED UNDER ICON'S WARRANTY POLICY.</p>	



WARNING!

**** READ ALL INSTRUCTIONS THOROUGHLY FROM START TO FINISH BEFORE BEGINNING INSTALLATION! IF THESE INSTRUCTIONS ARE NOT PROPERLY FOLLOWED SEVERE FRAME, SUSPENSION AND TIRE DAMAGE MAY RESULT TO THE VEHICLE!**

**** ICON VEHICLE DYNAMICS RECOMMENDS THAT YOU EXERCISE EXTREME CAUTION WHEN WORKING UNDER A VEHICLE THAT IS SUPPORTED WITH JACK STANDS.**

**** ICON VEHICLE DYNAMICS RECOMMENDS ALL INSTALLATION TO BE PERFORMED BY A PROFESSIONAL SHOP/SERVICE TECHNICIAN. PRODUCT FAILURE CAUSED BY IMPROPER INSTALLATION WILL NOT BE COVERED UNDER ICON'S WARRANTY POLICY.**

INSTALLATION

- Using a properly rated jack, raise the rear of the vehicle and support the frame rails with jack stands. Ensure the jack stands are secure and set properly before lowering the jack. NEVER WORK UNDER AN UNSUPPORTED VEHICLE. Remove the rear wheels.
- Remove the factory shock using (2) 17mm.
- The lower shock mount will need to be trimmed to allow for clearance on the RXT shock. [FIGURE 1 & 2]

FIG.1



FIG.2



- Paint any exposed metal to avoid corrosion.

5. Install the RXT shock using the factory lower bolt and a 17mm. [FIGURE 3]

FIG.3



6. Install stem bushings and hardware as shown in the diagram: Install the first nut and fasten until there are enough exposed threads available to secure the second jam nut. Install jam nut until it is flush with the top of the stem (DO NOT OVERTIGHTEN) and torque to 50 ft-lbs while holding the lower nut with a 19mm wrench. Do not overtighten bushing assembly, as this can lead to shock stem failure. Failure caused by incorrect installation of stem bushings and hardware is NOT covered under ICON's warranty policy.

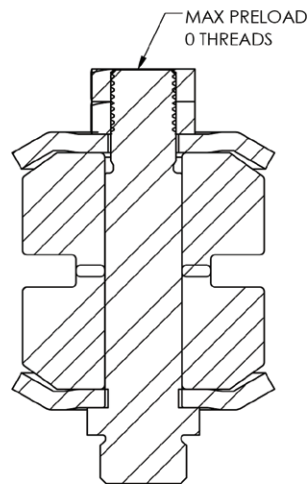

7. Mount the reservoir bracket to the reservoir using the supplied hose clamps and a 5/16”.

8. Hold the reservoir against the frame and mark the hole location of the mounting hole from the reservoir bracket. (Be sure to account for the added slack needed if installing the ICON Hydraulic Bump Stop System #56108) [FIGURE 4]

FIG.4



9. Remove the reservoir bracket from the reservoir.

10. Center punch the hole location previously marked. Drill an 17/32” hole in the frame. Take care to not damage any lines running in the frame channel. [FIGURE 5 & 6]

FIG.5



FIG.6



- 11.** Thread the holes using the supplied 3/8” self tapping bolts and a 9/16”.
- 12.** Mount the reservoir bracket using the self tapping bolts 605144 & 605131 washers.
- 13.** Mount the reservoir to the bracket using a 5/16” and the supplied hose clamps. [FIGURE 7]

FIG.7



14. Install wheels and lower the vehicle back to the ground. [Torque lugs to factory spec]

***VERIFY ALL FASTENERS ARE PROPERLY TORQUED BEFORE DRIVING VEHICLE.
RETORQUE ALL NUTS, BOLTS AND LUGS AFTER 100 MILES AND PERIODICALLY THEREAFTER.***

2.5 VS SERIES SHOCK & COILOVER TECHNICAL INFORMATION

MAINTENANCE

ICON shock absorbers are a high quality rebuildable race style shock absorber designed for optimal performance. With a unit of this caliber on your vehicle, routine maintenance is required to keep them looking and operating in like new condition. Residual oil and assembly lube may be present at all seal paths from the factory out of the box and is considered normal. Pooling of oil however is not acceptable at any time and one should contact the ICON dealer where purchased.

BELOW ARE GUIDELINES BASED ON HOW YOU USE YOUR VEHICLE BUT YOUR MILEAGE MAY VARY:

STREET USE:

- Send in for factory servicing every 40,000 miles or if a leak develops, ride quality decreases, or they begin to make excessive noise.
- Remove any buildup of road salt, mud, or debris from shocks and coil springs anytime accrued
- Clean with mild soap and water with each oil change or anytime you notice build up.
- Wax the cylinders yearly with automotive wax to prevent corrosion.
- Check nitrogen pressure yearly. (252004 charge needle assembly available at any ICON distributor)
- Check bearings for excessive wear yearly.
- DO NOT apply any type of lube to the upper and lower bearings.

STREET/DIRT:

- Send in for factory servicing every 15,000 miles or if a leak develops, ride quality decreases, or they begin to make excessive noise.
- Clean with mild soap and water with each oil change, offroad trip, or anytime you notice build up.
- Wax the cylinders yearly with automotive wax to prevent corrosion.
- Check nitrogen pressure each dirt outing. (252004 charge needle assembly available at any ICON distributor)
- Check bearings for excessive wear yearly.
- DO NOT apply any type of lube to the upper and lower bearings.

DIRT USE:

- Send in for factory servicing every 1,000 miles.
- Check nitrogen pressure each outing. (252004 charge needle assembly available at any ICON distributor)
- Remove any buildup of mud or debris from shocks and coil springs after every outing.

SELF-SERVICE:

- Contact ICON for service kits & tools at (951) 689-4266.

PRODUCT REGISTRATION

Please visit: <http://www.iconvehicledynamics.com/tech-support/registration/> to register your product.

ICON VEHICLE DYNAMICS SHOCK ABSORBER WARRANTY

This shock absorber has a 1 year warranty against any manufacturer's defects. If a shock fails within the initial year of ownership, the shock must be shipped to ICON Vehicle Dynamics for inspection and service. If a shock is inspected and it has been determined the shock failed due to neglect, damage caused by improper installation or any other reason besides "normal wear and tear", the owner of said shock is responsible for all service costs. This includes labor, parts, and shipping.

ICON Vehicle Dynamics warrants to the original retail purchaser who owns the vehicle on which the product was originally installed. ICON Vehicle Dynamics does not warrant the product for finish, alterations, modifications and/or installation contrary to ICON Vehicle Dynamics instructions. ICON Vehicle Dynamics products are not designed, nor are they intended to be installed on vehicles used in race applications, for racing purposes or for similar activities. (A "race" is defined as any contest between two or more vehicles, or a contest of one or more vehicles against the clock, whether or not such contest is for a prize). This warranty does not include coverage for police or taxi vehicles, race vehicles, or vehicles used for government or commercial purposes. Also excluded from this warranty are sales outside of the United States of America and Canada.

ICON Vehicle Dynamics' obligation under this warranty is limited to the repair or replacement, at ICON Vehicle Dynamics' discretion, of the defective product. Any and all costs of removal, installation or re-installation, freight charges and incidental or consequential damages are expressly excluded from this warranty. Items that are subject to wear are not considered defective when worn and are not covered.

ICON Vehicle Dynamics components must be installed as a complete kit as shown in our current application guide. Any substitutions or exemptions of required components will immediately void the warranty. Some finish damage may happen to parts during shipping and is not covered under warranty.

This warranty is expressly in lieu of all other warranties expressed or implied. This warranty shall not apply to any product that has been improperly installed, modified or customized subject to accident, negligence, abuse or misuse.

To send a shock in for warranty please visit our website <http://www.iconvehicledynamics.com/tech-support/shock-service/>



ICON VEHICLE DYNAMICS®
PERFORMANCE SUSPENSION SYSTEMS AND SHOCK ABSORBERS

7929 Lincoln Ave. Riverside, CA 92504 Phone: 951.689.ICON Fax: 951.689.1016
www.iconvehicledynamics.com



FOLLOW US ON FACEBOOK!



7929 Lincoln Ave. Riverside, CA 92504
Phone: 951.689.ICON | Fax: 951.689.1016

PART #	DESCRIPTION
158509	07-21 TUNDRA MULTI RATE RXT LEAF PACK W/ ADD IN LEAF

COMPONENTS INCLUDED	
(1) 158509 07-21 TUNDRA MULTI RATE RXT LEAF PACK W/ ADD IN LEAF	
HARDWARE INCLUDED	
158509H HARDWARE KIT	
(1) LEAF SPRING LINER (1) LEAF SPRING CENTER PIN W/ NUT	(1) LEAF SPRING U-CLIP
TOOLS REQUIRED	
JACK JACK STANDS TORQUE WRENCH 9/16" SOCKET / WRENCH	7/8" SOCKET / WRENCH 12MM SOCKET / WRENCH 17MM SOCKET / WRENCH 19MM SOCKET / WRENCH
TECH NOTES	
<p>1. ICON MULTI-RATE LEAF SPRING KIT REQUIRES TOYOTA U-BOLT KIT (52050) FOR INSTALLATION.</p> <p>2. THE ICON MULTI RATE LEAF SPRING IS MODULAR, MEANING THAT YOU CAN CONFIGURE THE SPRING PACK TO YOUR DESIRED SETTING FROM THESE AVAILABLE OPTIONS:</p> <p>OPTION #1 - THE SPRING IS SHIPPED AT THIS SETTING (LIGHTEST SPRING RATE).</p> <p>OPTION #2 - REPLACE THE 3RD SPRING (COUNTING FROM THE TOP DOWN) WITH THE ADDITIONAL LEAF.</p> <p>OPTION #3 - PLACE THE ADDITIONAL LEAF BETWEEN THE 3RD AND 4TH SPRING (COUNTING FROM THE TOP DOWN). DO NOT REMOVE LEAF FROM SPRING PACK.</p> <p>ICON'S MEASURED SPECS FROM THE TEST TRUCK (2016 4WD CREW CAB TUNDRA):</p> <p>OPTION #1 - LIFT HEIGHT OVER STOCK: + 1.75" (UNLOADED) (RECOMMENDED FOR CONSTANT LOAD UP TO 250 LBS)</p> <p>OPTION #2 - LIFT HEIGHT OVER STOCK + 3.00" (UNLOADED) (RECOMMENDED FOR CONSTANT LOAD OF 250-500 LBS)</p> <p>OPTION #3 - LIFT HEIGHT OVER STOCK: + 4.00" (UNLOADED) (RECOMMENDED FOR CONSTANT LOAD OF 500-750 LBS)</p> <p>Note: Location of weight in rear of vehicle will also have an effect on rear ride height. For example, weight mounted in bumper/tailgate area will have greater reduction in rear ride height than the same amount of weight mounted toward front of bed area.</p> <p>Note: Level stance with 3" front-end lift may not be achievable with rear lift heights above 1.75" over stock. Consider desired vehicle stance, available front-end lift range, as well as constant rear weight and its location when determining spring pack configuration.</p>	

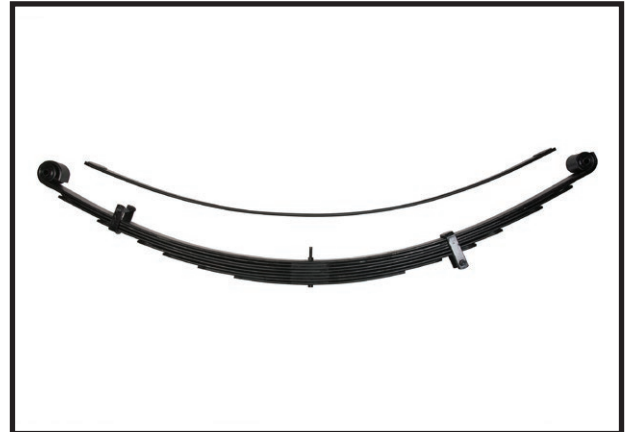

WARNING!
<p>** READ ALL INSTRUCTIONS THOROUGHLY FROM START TO FINISH BEFORE BEGINNING INSTALLATION! IF THESE INSTRUCTIONS ARE NOT PROPERLY FOLLOWED SEVERE FRAME, SUSPENSION AND TIRE DAMAGE MAY RESULT TO THE VEHICLE!</p> <p>** ICON VEHICLE DYNAMICS RECOMMENDS THAT YOU EXERCISE EXTREME CAUTION WHEN WORKING UNDER A VEHICLE THAT IS SUPPORTED WITH JACK STANDS.</p> <p>** ICON VEHICLE DYNAMICS RECOMMENDS ALL INSTALLATION TO BE PERFORMED BY A PROFESSIONAL SHOP/SERVICE TECHNICIAN. PRODUCT FAILURE CAUSED BY IMPROPER INSTALLATION WILL NOT BE COVERED UNDER ICON'S WARRANTY POLICY.</p>

6. Remove the pivot bolt from the front frame mount using (2) 19mm. [FIGURE 1]

7. Remove the upper and lower nut from the spring shackle using a 19mm.

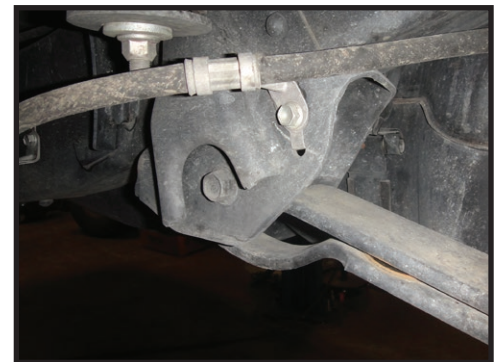

FIG.1

INSTALLATION

- Using a properly rated jack, raise the rear of the vehicle and support the frame rails with jack stands. Ensure the jack stands are secure and set properly before lowering the jack. NEVER WORK UNDER AN UNSUPPORTED VEHICLE. Remove the rear wheels.
- Remove the lower shock bolt using (2) 19mm.
- Disconnect the parking brake bracket from the axle using a 12mm.
- Support the axle using the floor jack. Remove the U-bolts from one side of the truck using a 19mm.
- Slowly lower the axle being careful to not overextend brake lines or ABS wires.

8. Remove the shackle plate from the nut side of the shackle. [FIGURE 2]

FIG.2



9. Remove the shackle from the inside of the frame rail. This may require removal of the spare tire.

10. Lift the factory spring out being careful to not damage brake lines, hoses, and ABS wires. Two people are recommended, as leaf springs are very heavy.

If adjusting the **MULTI RATE** spring configuration:

A. Remove the front clip bolts and rear clip using a 9/16". [FIGURE A]

FIG.A



FIG.B

B. Clamp the pack on both sides of the center pin. [FIGURE B]

C. Use locking pliers to hold the head of the center pin and remove the nut using a 9/16".

D. Carefully release the clamps from the spring pack. Use caution, as the pack may still have tension upon release.

E. Remove the top two leaves from the spring pack. [FIGURE C]

FIG.C



F. Configure the spring pack as desired from the available options.

G. You can either replace the 3rd leaf (counting from the leaf down) with the additional leaf, or add the additional leaf between spring #3 and #4.

Option #1: Standard (as shipped) = 30% reduced ride rate from stock. (+1.75" over stock unloaded)

Option #2: Additional leaf #3 = 20% over standard ICON configuration. (+3.00" over stock unloaded)

Option #3: Standard + Additional leaf = 40% over standard ICON configuration. (+4.00" over stock unloaded)

Option #1: Recommended for constant loads up to 250lbs.

Option #2: Recommended for constant loads from 250-500lbs. (+250lbs = 2.00" lift | +500lbs = 1.35" lift)

Option #3: Recommended for constant loads from 500-750lbs. (+750lbs = 1.50" lift)

H. Be sure there is a liner between each leaf.

I. Slide the center pin through the pack and clamp together using clamps on both sides of the center pin. Once the center pin is through the whole pack, start the nut. [Torque to 15 ft-lbs]

J. Install the appropriate clips for the configuration. Longer clips are provided for additional pack thickness.

11. Lift the MULTI RATE spring pack into place. Loosely install the shackle, shackle plate, and nuts. Do not tighten.

12. Mount the spring in the front frame pocket using the factory bolt and nut. Do not tighten. Lift the axle and guide the center pin into the location hole in the spring pad on the axle tube.

13. Place the factory bump stop or ICON striker plate on top of the spring. The center pin may need to be trimmed. **[FIGURE 3]**



FIG.3



FIG.4

14. Install the U-bolts and tighten. **[FIGURE 4]**

15. Connect the parking brake brackets to the axle using a 12mm and the factory bolt.

16. If the rubber brake lines are too tight at full droop, the brake line bracket (on top of the rear differential) can be hand formed upwards for some extra clearance.

17. Install shocks and wheels and set the vehicle on the ground.

18. Torque shackle nuts and front spring bolt to factory spec. **[FIGURE 5 & 6]**



FIG.5



FIG.6

19. Torque U-bolts to 90ft-lbs.

***VERIFY ALL FASTENERS ARE PROPERLY TORQUED BEFORE DRIVING VEHICLE.
RETORQUE ALL NUTS, BOLTS AND LUGS AFTER 100 MILES AND PERIODICALLY THEREAFTER.***

MULTI-RATE LEAF SPRING RATE CHANGE OPTIONS

(General application for all models. Refer to these instructions for specific rates)

OPTION 1

ADDITIONAL
LEAF
NOT USED

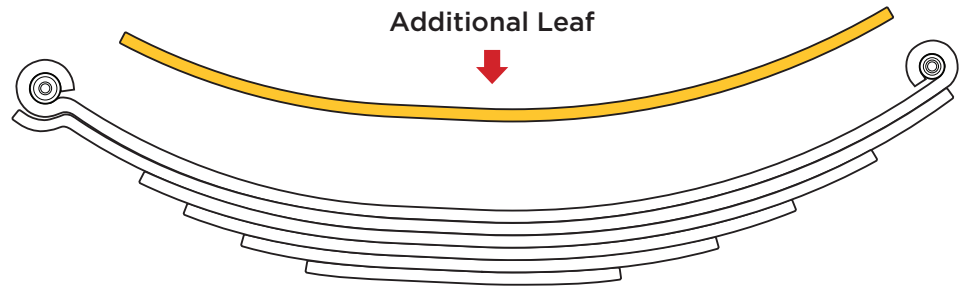

OPTION 2

ADDITIONAL
LEAF
REPLACES
LEAF

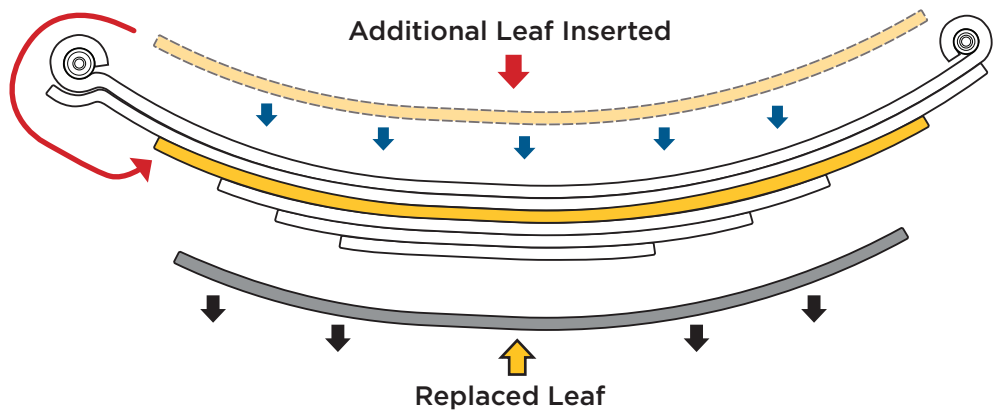

OPTION 3

ADDITIONAL
LEAF ADDED
TO PACK

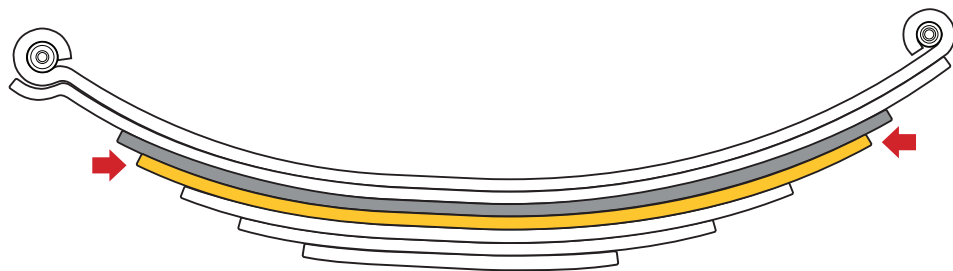



2007-2017 TOYOTA TUNDRA RXT MULTI-RATE LEAF SPRING

OPTION 1

INSTALL SPRING IN ORIGINAL CONFIGURATION, LEAVING ADDITIONAL LEAF OUT

LIFT HEIGHT OVER STOCK:
1.75"
(UNLOADED)

IMAGE SHOWN WITH NO WEIGHT IN BED

AS SHIPPED



OPTION 2

REPLACE THE 3RD SPRING IN THE PACK WITH THE ADDITIONAL LEAF PROVIDED IN KIT

LIFT HEIGHT OVER STOCK:
3.00"
(UNLOADED)

2.00"
(250LB LOAD)

IMAGE SHOWN WITH 250LB LOAD IN BED

LEAF REPLACEMENT



OPTION 3

ADD THE ADDITIONAL LEAF PROVIDED TO THE PACK, IN BETWEEN THE 3RD AND 4TH SPRING

LIFT HEIGHT OVER STOCK:
4.00"
(UNLOADED)

1.50"
(750LB LOAD)

IMAGE SHOWN WITH 750LB LOAD IN BED

LEAF ADDITION



ICON VEHICLE DYNAMICS LIMITED LIFETIME WARRANTY

ICON Vehicle Dynamics warrants to the original retail purchaser who owns the vehicle on which the product was originally installed. ICON Vehicle Dynamics does not warrant the product for finish, alterations, modifications and/or installation contrary to ICON Vehicle Dynamics instructions. ICON Vehicle Dynamics products are not designed, nor are they intended to be installed on vehicles used in race applications, for racing purposes or for similar activities. (A "race" is defined as any contest between two or more vehicles, or a contest of one or more vehicles against the clock, whether or not such contest is for a prize). This warranty does not include coverage for police or taxi vehicles, race vehicles, or vehicles used for government or commercial purposes. Also excluded from this warranty are sales outside of the United States of America and Canada.

ICON Vehicle Dynamics' obligation under this warranty is limited to the repair or replacement, at ICON Vehicle Dynamics' discretion, of the defective product. Any and all costs of removal, installation or re-installation, freight charges and incidental or consequential damages are expressly excluded from this warranty. Items that are subject to wear are not considered defective when worn and are not covered.

ICON Vehicle Dynamics components must be installed as a complete kit as shown in our current application guide. Any substitutions or exemptions of required components will immediately void the warranty. Some finish damage may happen to parts during shipping and is not covered under warranty.

This warranty is expressly in lieu of all other warranties expressed or implied. This warranty shall not apply to any product that has been improperly installed, modified or customized subject to accident, negligence, abuse or misuse.

ICON VEHICLE DYNAMICS LIABILITY DISCLAIMER

ICON does not make any representations or warranties regarding the fitness of any ICON product for a particular installation or conformance of any ICON product with a particular vehicle application. Installation of any ICON suspension system is at the sole discretion of the end user and in making a purchase of any ICON suspension system, the purchaser assumes the responsibility and liability for any and all damage or injury, of any kind or nature whatsoever, caused by, resulting from, arising out of, or occurring in connection with the use or installation of any ICON suspension system. ICON is not liable for and specifically disavows any installation that is not in conformance with original equipment manufacturer's recommendations or instructions. Purchaser agrees that in the event of any claim or lawsuit arising out of the installation or use of an ICON suspension system, purchaser shall indemnify and hold harmless ICON, its agents, employees, officers and owners from and against any and all loss, expense, damage or injury that ICON may sustain as the result of such claim. [If applicable, ICON defers to and recommends recalibration of any/all vehicle stability systems after suspension installation.]



ICON VEHICLE DYNAMICS®
PERFORMANCE SUSPENSION SYSTEMS AND SHOCK ABSORBERS

7929 Lincoln Ave. Riverside, CA 92504 Phone: 951.689.ICON Fax: 951.689.1016
www.iconvehicledynamics.com



FOLLOW US ON FACEBOOK!

