

7929 Lincoln Ave. Riverside, CA 92504  
Phone: 951.689.ICON | Fax: 951.689.1016

| PART # | DESCRIPTION  |
|--------|--|
| 51210  | 22-23 TUNDRA .5" LIFT TRIPLE RATE REAR COIL SPRING KIT |

| COMPONENTS INCLUDED  |  |
|--|--|
| (2) 158750 A 22-UP TUNDRA REAR 0.50" LIFT TRIPLE RATE COIL SPRING  |  |
| HARDWARE INCLUDED  |  |
| N/A  |  |
| TOOLS REQUIRED   |  |
| JACK<br>JACK STANDS<br>TORQUE WRENCH<br>RATCHETS   | 12MM SOCKET/WRENCH<br>17MM SOCKET / WRENCH<br>COIL SPRING COMPRESSOR |
| TECH NOTES   |  |
| <p>1. .5" LIFT ON NON TRD MODELS ONLY.</p> <p>2. WILL NOT WORK ON AIR RIDE EQUIPPED VEHICLES.</p> <p>3. ESTIMATED INSTALL TIME: 2 HOURS.</p> |  |



| WARNING!  |
|---|
| <p>** READ ALL INSTRUCTIONS THOROUGHLY FROM START TO FINISH BEFORE BEGINNING INSTALLATION! IF THESE INSTRUCTIONS ARE NOT PROPERLY FOLLOWED SEVERE FRAME, SUSPENSION AND TIRE DAMAGE MAY RESULT TO THE VEHICLE!</p> <p>** ICON VEHICLE DYNAMICS RECOMMENDS THAT YOU EXERCISE EXTREME CAUTION WHEN WORKING UNDER A VEHICLE THAT IS SUPPORTED WITH JACK STANDS.</p> <p>** ICON VEHICLE DYNAMICS RECOMMENDS ALL INSTALLATION TO BE PERFORMED BY A PROFESSIONAL SHOP/SERVICE TECHNICIAN. PRODUCT FAILURE CAUSED BY IMPROPER INSTALLATION WILL NOT BE COVERED UNDER ICON'S WARRANTY POLICY.</p> |

## INSTALLATION

Place vehicle in park on a level surface. Engage parking brake. Block the front tires. Lift rear of vehicle and place jack stands under the manufacturer recommended locations. NEVER WORK UNDER AN UNSUPPORTED VEHICLE.

**OPTION 1:** No spring compressor available.

1. Place a jack under the center of the axle so it can be lowered to assist in spring removal.
2. Using a 12mm, remove the brake line, E-brake line, speed sensor and E-locker wiring brackets.
3. Remove the lower shock eyelet using a 17mm and pull the shock off the mounting stud. [FIGURE 1]

FIG.1



4. Slowly lower the axle down until the springs become loose, being careful not to overextend any brake lines or wiring harness.
5. Lift the spring and pull it out from the bottom, rotating it can help to clear the mount on the axle housing spring perch.
6. Remove the bump stop cone from the factory spring and install it into the new ICON spring, then install it into the truck. Being sure the lower spring seat is in the spring perch correctly. Repeat on passenger side.
7. Reinstall shocks and brake lines.

**OPTION 2:** Use a spring compressor.

**1.** Use a spring compressor like the one shown. [FIGURE 2]

FIG.2



**2.** Leave all brackets attached. Remove the lower shock mount with a 17mm and lower the axle, being sure not to overextend any brake lines or wiring harness.

**3.** Install spring compressor with appropriate spring attachment and tighten to compress the spring until it can be removed. [FIGURE 3]

FIG.3



**4.** Remove the spring compressor from the factory spring and install it onto the new ICON spring.

**5.** Remove the bump stop cone from the factory spring and install it into the new ICON spring. Compress the spring enough so that it can be installed into the truck, making sure the spring seats into the upper and lower spring perch correctly. Repeat on passenger side.

**6.** Reinstall wheels and tires, enjoy your new springs and ride.

***VERIFY ALL FASTENERS ARE PROPERLY TORQUED BEFORE DRIVING VEHICLE.***

***RETORQUE ALL NUTS, BOLTS AND LUGS AFTER 100 MILES AND PERIODICALLY THEREAFTER.***

## ICON VEHICLE DYNAMICS LIMITED LIFETIME WARRANTY

ICON Vehicle Dynamics warrants to the original retail purchaser who owns the vehicle on which the product was originally installed. ICON Vehicle Dynamics does not warrant the product for finish, alterations, modifications and/or installation contrary to ICON Vehicle Dynamics instructions. ICON Vehicle Dynamics products are not designed, nor are they intended to be installed on vehicles used in race applications, for racing purposes or for similar activities. (A "race" is defined as any contest between two or more vehicles, or a contest of one or more vehicles against the clock, whether or not such contest is for a prize). This warranty does not include coverage for police or taxi vehicles, race vehicles, or vehicles used for government or commercial purposes. Also excluded from this warranty are sales outside of the United States of America and Canada.

ICON Vehicle Dynamics' obligation under this warranty is limited to the repair or replacement, at ICON Vehicle Dynamics' discretion, of the defective product. Any and all costs of removal, installation or re-installation, freight charges and incidental or consequential damages are expressly excluded from this warranty. Items that are subject to wear are not considered defective when worn and are not covered.

ICON Vehicle Dynamics components must be installed as a complete kit as shown in our current application guide. Any substitutions or exemptions of required components will immediately void the warranty. Some finish damage may happen to parts during shipping and is not covered under warranty.

This warranty is expressly in lieu of all other warranties expressed or implied. This warranty shall not apply to any product that has been improperly installed, modified or customized subject to accident, negligence, abuse or misuse.



**ICON VEHICLE DYNAMICS®**  
PERFORMANCE SUSPENSION SYSTEMS AND SHOCK ABSORBERS

7929 Lincoln Ave. Riverside, CA 92504 Phone: 951.689.ICON Fax: 951.689.1016  
[www.iconvehicledynamics.com](http://www.iconvehicledynamics.com)



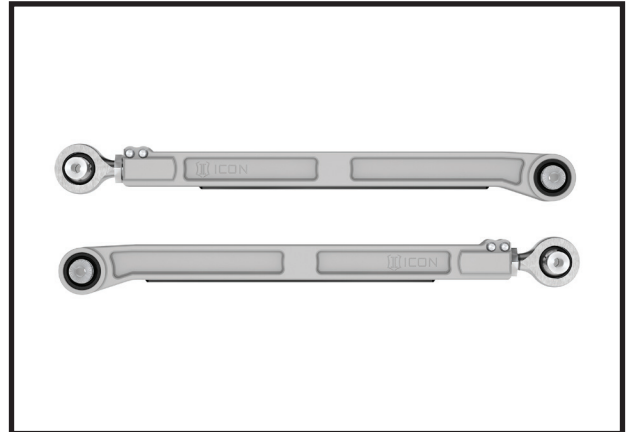
**FOLLOW US ON FACEBOOK!**



7929 Lincoln Ave. Riverside, CA 92504  
Phone: 951.689.ICON | Fax: 951.689.1016

| PART # | DESCRIPTION                        |
|--------|------------------------------------|
| 54002  | 22-UP TUNDRA BILLET LOWER LINK KIT |

| COMPONENTS INCLUDED   |   |
|---|---|
| (2) 157552 22-UP TUNDRA REAR LOWER LINK<br>(2) 157546 22-UP TUNDRA SERRATED SPACER .259<br>(2) 157548 22-UP TUNDRA SERRATED SLEEVE .259<br>(2) 157420 NUT PLATE 3/8-16 X 2<br>(4) 157551 HEIM SPACER 1.00 X .559 X 2.834  | (2) 167014 L/R ADJUSTER SLEEVE 1.25-12L / 1.00-14<br>(2) 127205 16.6" TRAILING ARM WEAR STRIP<br>(2) 295510 JM16-1T 1-14 RH ROD END F2 FIT<br>(2) 297102 GREASELESS PRESS IN BUSHING 2.135 X 14.3 X 58.85MM |
| HARDWARE INCLUDED   |   |
| (14) 605018 10-32 X .438 FLAT HEAD SCREW STAINLESS  | (4) 605146 3/8-16 X 1.5 12 PT FLANGED CAP SCREW   |
| TOOLS REQUIRED  |   |
| JACK<br>JACK STANDS<br>TORQUE WRENCH  | 19MM SOCKET / WRENCH<br>3/8 12-PT SOCKET / WRENCH   |
| TECH NOTES  |   |
| <p>1. DO NOT EXCEED 3.375" ADJUSTMENT FROM THE CENTER OF THE ROD END TO THE EDGE OF THE BILLET LINK. FAILURE CAUSED BY EXCESSIVE ADJUSTMENT WILL NOT BE COVERED UNDER ICON'S WARRANTY POLICY.</p> <p>2. LINKS ARE PRESET TO 26.938" (FACTORY LENGTH).</p> <p>3. IF CUSTOM PINION ANGLE IS DESIRED YOU CAN ADJUST THIS WITH THE VEHICLE ON THE GROUND.</p> |   |



| WARNING!  |
|---|
| <p>** READ ALL INSTRUCTIONS THOROUGHLY FROM START TO FINISH BEFORE BEGINNING INSTALLATION! IF THESE INSTRUCTIONS ARE NOT PROPERLY FOLLOWED SEVERE FRAME, SUSPENSION AND TIRE DAMAGE MAY RESULT TO THE VEHICLE!</p> <p>** ICON VEHICLE DYNAMICS RECOMMENDS THAT YOU EXERCISE EXTREME CAUTION WHEN WORKING UNDER A VEHICLE THAT IS SUPPORTED WITH JACK STANDS.</p> <p>** ICON VEHICLE DYNAMICS RECOMMENDS ALL INSTALLATION TO BE PERFORMED BY A PROFESSIONAL SHOP/SERVICE TECHNICIAN. PRODUCT FAILURE CAUSED BY IMPROPER INSTALLATION WILL NOT BE COVERED UNDER ICON'S WARRANTY POLICY.</p> |

## INSTALLATION

**1.** Lift vehicle and securely place heavy duty jack stands under the manufacturer recommended lifting locations for the back of the vehicle. NEVER WORK UNDER AN UNSUPPORTED VEHICLE. Remove the wheels.

**2.** Remove the driver side rear upper link using a 19mm. [FIGURE 1]



FIG.1

**3.** Install the billet link with the heim joint toward the frame and the pinch bolts up. The pinch bolts should be on the outer side of the link. Tighten the factory hardware to factory spec using a 19mm. [FIGURE 2]



FIG.2

4. Repeat steps on opposite side of vehicle.
5. To adjust, loosen the pinch bolts billet link using a 3/8" 12pt. Turn the L/R adjusting collar until desired length is reached.
6. Make sure that the slit in the collar is lined up with the slit in the pinch housing and tighten pinch bolts using an alternating pattern [Torque to 40 ft-lbs]. Go back and forth between bolts 3 times to torque equally.
7. Never exceed the maximum length as listed in the tech notes

[TECH NOTE #1]



**VERIFY ALL FASTENERS ARE PROPERLY TORQUED BEFORE DRIVING VEHICLE.**

**RETORQUE ALL NUTS, BOLTS AND LUGS AFTER 100 MILES AND PERIODICALLY THEREAFTER.**

### ICON VEHICLE DYNAMICS LIMITED LIFETIME WARRANTY

ICON Vehicle Dynamics warrants to the original retail purchaser who owns the vehicle on which the product was originally installed. ICON Vehicle Dynamics does not warrant the product for finish, alterations, modifications and/or installation contrary to ICON Vehicle Dynamics instructions. ICON Vehicle Dynamics products are not designed, nor are they intended to be installed on vehicles used in race applications, for racing purposes or for similar activities. (A "race" is defined as any contest between two or more vehicles, or a contest of one or more vehicles against the clock, whether or not such contest is for a prize). This warranty does not include coverage for police or taxi vehicles, race vehicles, or vehicles used for government or commercial purposes. Also excluded from this warranty are sales outside of the United States of America and Canada.

ICON Vehicle Dynamics' obligation under this warranty is limited to the repair or replacement, at ICON Vehicle Dynamics' discretion, of the defective product. Any and all costs of removal, installation or re-installation, freight charges and incidental or consequential damages are expressly excluded from this warranty. Items that are subject to wear are not considered defective when worn and are not covered.

ICON Vehicle Dynamics components must be installed as a complete kit as shown in our current application guide. Any substitutions or exemptions of required components will immediately void the warranty. Some finish damage may happen to parts during shipping and is not covered under warranty.

This warranty is expressly in lieu of all other warranties expressed or implied. This warranty shall not apply to any product that has been improperly installed, modified or customized subject to accident, negligence, abuse or misuse.



**ICON VEHICLE DYNAMICS®**  
PERFORMANCE SUSPENSION SYSTEMS AND SHOCK ABSORBERS

7929 Lincoln Ave. Riverside, CA 92504 Phone: 951.689.ICON Fax: 951.689.1016  
www.iconvehicledynamics.com



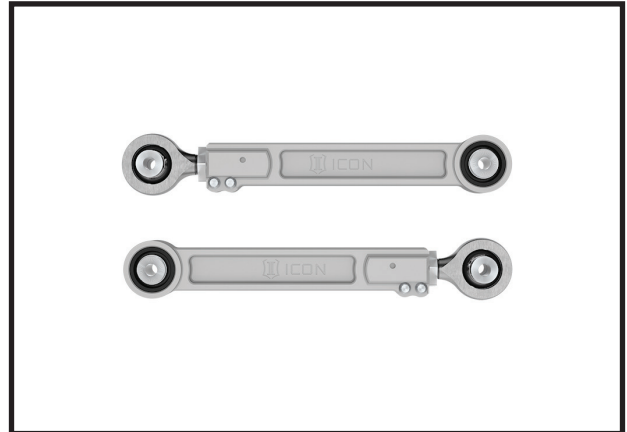
**FOLLOW US ON FACEBOOK!**



7929 Lincoln Ave. Riverside, CA 92504  
Phone: 951.689.ICON | Fax: 951.689.1016

| PART # | DESCRIPTION                        |
|--------|------------------------------------|
| 54102  | 22-UP TUNDRA BILLET UPPER LINK KIT |

| COMPONENTS INCLUDED   |   |
|---|---|
| (2) 157553 22-UP TUNDRA REAR UPPER LINK<br>(2) 157547 22-UP TUNDRA SERRATED SPACER .200<br>(2) 157549 22-UP TUNDRA SERRATED SLEEVE .200<br>(2) 157420 NUT PLATE 3/8-16 X 2<br>(4) 157551 HEIM SPACER 1.00 X .559 X 2.834  | (2) 167014 L/R ADJUSTER SLEEVE 1.25-12L / 1.00-14<br>(2) 295510 JM16-IT 1-14 RH ROD END F2 FIT<br>(2) 297102 GREASELESS PRESS IN BUSHING 2.135 X 14.3 X 58.85MM |
| HARDWARE INCLUDED   |   |
| (4) 605146 3/8-16 X 1.5 12 PT FLANGED CAP SCREW   |   |
| TOOLS REQUIRED  |   |
| JACK<br>JACK STANDS<br>TORQUE WRENCH<br>DIE GRINDER   | PAINT PEN (BLACK)<br>19MM SOCKET / WRENCH<br>3/8 12-PT SOCKET / WRENCH  |
| TECH NOTES  |   |
| <p>1. IF EQUIPPED WITH AIR RIDE SUSPENSION, KIT PN-55153 IS REQUIRED.</p> <p>2. DO NOT EXCEED 3.375" ADJUSTMENT FROM THE CENTER OF THE ROD END TO THE EDGE OF THE BILLET LINK. FAILURE CAUSED BY EXCESSIVE ADJUSTMENT WILL NOT BE COVERED UNDER ICON'S WARRANTY POLICY.</p> <p>3. LINKS ARE PRESET TO 15.438" (FACTORY LENGTH).</p> <p>4. IF CUSTOM PINION ANGLE IS DESIRED YOU CAN ADJUST THIS WITH THE VEHICLE ON THE GROUND.</p> |   |



| WARNING!  |
|---|
| <p>** READ ALL INSTRUCTIONS THOROUGHLY FROM START TO FINISH BEFORE BEGINNING INSTALLATION! IF THESE INSTRUCTIONS ARE NOT PROPERLY FOLLOWED SEVERE FRAME, SUSPENSION AND TIRE DAMAGE MAY RESULT TO THE VEHICLE!</p> <p>** ICON VEHICLE DYNAMICS RECOMMENDS THAT YOU EXERCISE EXTREME CAUTION WHEN WORKING UNDER A VEHICLE THAT IS SUPPORTED WITH JACK STANDS.</p> <p>** ICON VEHICLE DYNAMICS RECOMMENDS ALL INSTALLATION TO BE PERFORMED BY A PROFESSIONAL SHOP/SERVICE TECHNICIAN. PRODUCT FAILURE CAUSED BY IMPROPER INSTALLATION WILL NOT BE COVERED UNDER ICON'S WARRANTY POLICY.</p> |

## INSTALLATION

- Lift vehicle and securely place heavy duty jack stands under the manufacturer recommended lifting locations for the back of the vehicle. NEVER WORK UNDER AN UNSUPPORTED VEHICLE. Remove the wheels.
- If the vehicle is equipped with air-ride suspension, refer to PN-55153 instructions for disconnecting the position sensing arm from the link.
- Remove the driver side rear upper link using a 19mm. [FIGURE 1 & 2]

FIG.1

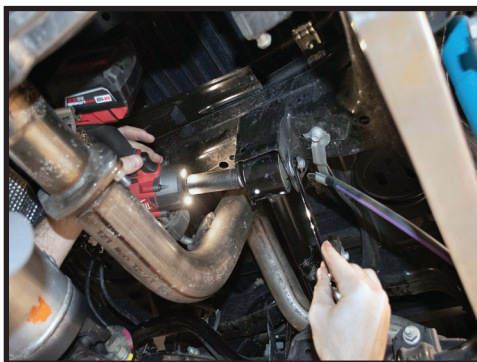
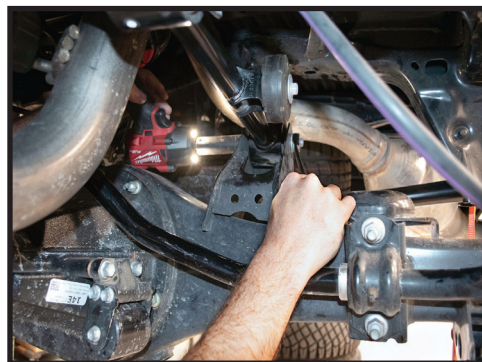


FIG.2



**4.** The pocket on the differential requires trimming for the billet link. Using a die grinder, grind the radius on the pocket gusset as shown. [FIGURE 3 & 4]

FIG.3

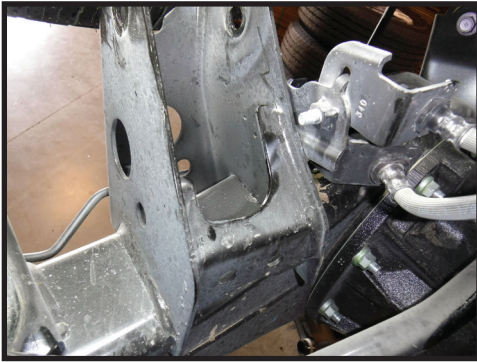
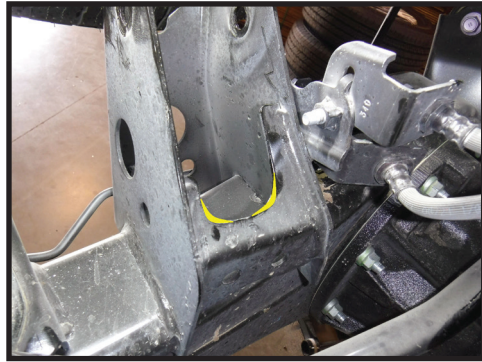


FIG.4



**5.** Paint exposed metal using a paint pen.

**6.** Install the billet link with the heim joint toward the frame and the pinch bolts down. The pinch bolts should be on the outer side of the link. Tighten the factory hardware to factory spec using a 19mm. [FIGURE 5]

FIG.5



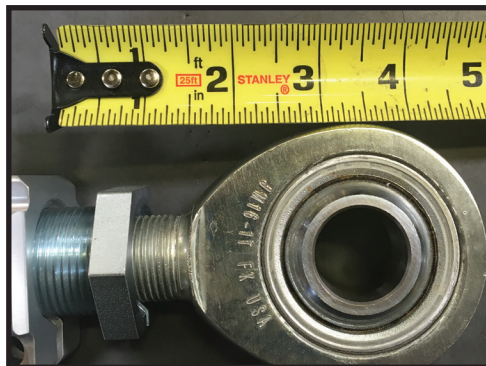
**7.** Repeat steps on opposite side of vehicle.

**8.** To adjust, loosen the pinch bolts billet link using a 3/8" 12pt. Turn the L/R adjusting collar until desired length is reached.

**9.** Make sure that the slit in the collar is lined up with the slit in the pinch housing and tighten pinch bolts using an alternating pattern [Torque to 40 ft-lbs]. Go back and forth between bolts 3 times to torque equally.

**10.** Never exceed the maximum length as listed in the tech notes.

[TECH NOTE #1]



**VERIFY ALL FASTENERS ARE PROPERLY TORQUED BEFORE DRIVING VEHICLE.**

**RETORQUE ALL NUTS, BOLTS AND LUGS AFTER 100 MILES AND PERIODICALLY THEREAFTER.**

## ICON VEHICLE DYNAMICS LIMITED LIFETIME WARRANTY

ICON Vehicle Dynamics warrants to the original retail purchaser who owns the vehicle on which the product was originally installed. ICON Vehicle Dynamics does not warrant the product for finish, alterations, modifications and/or installation contrary to ICON Vehicle Dynamics instructions. ICON Vehicle Dynamics products are not designed, nor are they intended to be installed on vehicles used in race applications, for racing purposes or for similar activities. (A "race" is defined as any contest between two or more vehicles, or a contest of one or more vehicles against the clock, whether or not such contest is for a prize). This warranty does not include coverage for police or taxi vehicles, race vehicles, or vehicles used for government or commercial purposes. Also excluded from this warranty are sales outside of the United States of America and Canada.

ICON Vehicle Dynamics' obligation under this warranty is limited to the repair or replacement, at ICON Vehicle Dynamics' discretion, of the defective product. Any and all costs of removal, installation or re-installation, freight charges and incidental or consequential damages are expressly excluded from this warranty. Items that are subject to wear are not considered defective when worn and are not covered.

ICON Vehicle Dynamics components must be installed as a complete kit as shown in our current application guide. Any substitutions or exemptions of required components will immediately void the warranty. Some finish damage may happen to parts during shipping and is not covered under warranty.

This warranty is expressly in lieu of all other warranties expressed or implied. This warranty shall not apply to any product that has been improperly installed, modified or customized subject to accident, negligence, abuse or misuse.



**ICON VEHICLE DYNAMICS®**  
PERFORMANCE SUSPENSION SYSTEMS AND SHOCK ABSORBERS

7929 Lincoln Ave. Riverside, CA 92504 Phone: 951.689.ICON Fax: 951.689.1016  
[www.iconvehicledynamics.com](http://www.iconvehicledynamics.com)



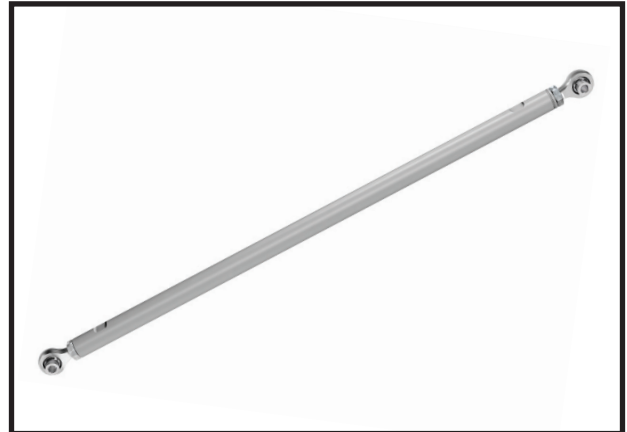
**FOLLOW US ON FACEBOOK!**



7929 Lincoln Ave. Riverside, CA 92504  
 Phone: 951.689.ICON | Fax: 951.689.1016

| PART # | DESCRIPTION                       |
|--------|-----------------------------------|
| 54202  | 22-UP TUNDRA BILLET TRACK BAR KIT |

| COMPONENTS INCLUDED   |   |
|---|---|
| (1) 157555 22-UP TUNDRA ALUMINUM REAR TRACK BAR<br>(4) 257432 HEIM SPACER JM12 X .562 X 1.965   | (1) 295514 RSMX12T ROD END F1 FIT<br>(1) 295532 RSMXL12T ROD END F1 FIT |
| HARDWARE INCLUDED   |   |
| (1) 605740 7/8-14 JAM NUT THIN  | (1) 605741 7/8-14 LEFT HAND JAM NUT THIN                                |
| TOOLS REQUIRED  |   |
| TORQUE WRENCH<br>19MM SOCKET / WRENCH   | 1-5/16" SOCKET / WRENCH   |
| TECH NOTES  |   |
| <p>1. TRACK BAR IS DESIGNED TO BE ADJUSTED ON THE VEHICLE WITH LEFT AND RIGHT HAND THREADS AT EACH END, THE WITNESS MARK AT THE END OF THE BAR INDICATES LEFT HAND THREAD. ADJUSTING IT OFF THE VEHICLE BY TURNING ONLY ONE ROD END WILL LEAD TO INCORRECT THREAD ENGAGEMENT AND FAILURE. ALWAYS ADJUST EQUALLY.</p> <p>2. SOLID MOUNTED ENDS INCREASE VEHICLE RESPONSE AND VEHICLE FEEDBACK BUT CAN GENERATE INCREASED ROAD NOISE.</p> <p>3. TRACK BAR SHOULD BE ADJUSTED ROUGHLY 1/16" LONGER FOR EACH INCH OF LIFT ASSUMING FACTORY TRACK BAR MOUNTING LOCATION. FINAL NUMBER DETERMINED BY PROFESSIONAL ALIGNMENT.</p> <p>4. TRACK BAR IS SET TO 41.938" (FACTORY LENGTH).</p> <p>5. DO NOT EXCEED 42.625" EYE TO EYE LENGTH.</p> |   |



| WARNING!  |
|---|
| <p>** READ ALL INSTRUCTIONS THOROUGHLY FROM START TO FINISH BEFORE BEGINNING INSTALLATION! IF THESE INSTRUCTIONS ARE NOT PROPERLY FOLLOWED SEVERE FRAME, SUSPENSION AND TIRE DAMAGE MAY RESULT TO THE VEHICLE!</p> <p>** ICON VEHICLE DYNAMICS RECOMMENDS THAT YOU EXERCISE EXTREME CAUTION WHEN WORKING UNDER A VEHICLE THAT IS SUPPORTED WITH JACK STANDS.</p> <p>** ICON VEHICLE DYNAMICS RECOMMENDS ALL INSTALLATION TO BE PERFORMED BY A PROFESSIONAL SHOP/SERVICE TECHNICIAN. PRODUCT FAILURE CAUSED BY IMPROPER INSTALLATION WILL NOT BE COVERED UNDER ICON'S WARRANTY POLICY.</p> |

## INSTALLATION

1. Remove the factory track bar using a 19mm. [FIGURE 1 & 2]

FIG.1

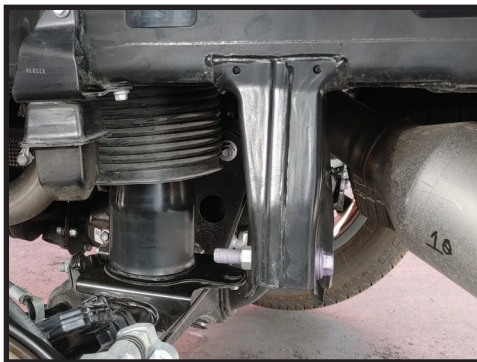


FIG.2



2. Install the billet track bar using the factory hardware and torque to factory spec using a 19mm. [FIGURE 3 & 4]

FIG.1



FIG.2



**3.** To adjust, loosen jam nuts using a 1-5/16" and turn the billet track bar. Once the differential is centered under the frame, torque the jam nuts to 180 ft-lbs.

**4.** Never exceed the maximum length as listed in the tech notes.

**VERIFY ALL FASTENERS ARE PROPERLY TORQUED BEFORE DRIVING VEHICLE.**

**RETORQUE ALL NUTS, BOLTS AND LUGS AFTER 100 MILES AND PERIODICALLY THEREAFTER.**

### **ICON VEHICLE DYNAMICS LIMITED LIFETIME WARRANTY**

ICON Vehicle Dynamics warrants to the original retail purchaser who owns the vehicle on which the product was originally installed. ICON Vehicle Dynamics does not warrant the product for finish, alterations, modifications and/or installation contrary to ICON Vehicle Dynamics instructions. ICON Vehicle Dynamics products are not designed, nor are they intended to be installed on vehicles used in race applications, for racing purposes or for similar activities. (A "race" is defined as any contest between two or more vehicles, or a contest of one or more vehicles against the clock, whether or not such contest is for a prize). This warranty does not include coverage for police or taxi vehicles, race vehicles, or vehicles used for government or commercial purposes. Also excluded from this warranty are sales outside of the United States of America and Canada.

ICON Vehicle Dynamics' obligation under this warranty is limited to the repair or replacement, at ICON Vehicle Dynamics' discretion, of the defective product. Any and all costs of removal, installation or re-installation, freight charges and incidental or consequential damages are expressly excluded from this warranty. Items that are subject to wear are not considered defective when worn and are not covered.

ICON Vehicle Dynamics components must be installed as a complete kit as shown in our current application guide. Any substitutions or exemptions of required components will immediately void the warranty. Some finish damage may happen to parts during shipping and is not covered under warranty.

This warranty is expressly in lieu of all other warranties expressed or implied. This warranty shall not apply to any product that has been improperly installed, modified or customized subject to accident, negligence, abuse or misuse.



**ICON VEHICLE DYNAMICS®**  
PERFORMANCE SUSPENSION SYSTEMS AND SHOCK ABSORBERS

7929 Lincoln Ave. Riverside, CA 92504 Phone: 951.689.ICON Fax: 951.689.1016  
[www.iconvehicledynamics.com](http://www.iconvehicledynamics.com)



**FOLLOW US ON FACEBOOK!**



7929 Lincoln Ave. Riverside, CA 92504  
 Phone: 951.689.ICON | Fax: 951.689.1016

| PART #  | DESCRIPTION                                |
|---------|--|
| 57840CP | 22-UP TUNDRA 0-1" REAR 2.5 VS CDCV RR PAIR |

| COMPONENTS INCLUDED   |  |
|---|--|
| (2) 154874C 22 TUNDRA 2.5 0-1" REAR VS CDCV RR UNPKG  |  |
| HARDWARE INCLUDED   |  |
| (2) 250003 10.00 UNIVERSAL RESI MT PLATE CZINC<br>(2) 605144 3/8-12 X .750 FLANGED SELF TAP BOLT CZINC  | (2) 611008 9/16 RXT HEAVY DUTY STEM BUSHING KIT<br>(2) 611051 #36 1.188-2.750 STAINLESS HOSE CLAMP KIT (4) |
| TOOLS REQUIRED  |  |
| JACK<br>JACK STANDS<br>TORQUE WRENCH<br>RATCHETS<br>EXTENSION<br>DRILL<br>11/32 DRILL BIT   | SHARPIE<br>8MM<br>17MM<br>19MM<br>9/16"<br>5/16" NUT DRIVER OR FLAT BLADE SCREW DRIVER                     |
| TECH NOTES  |  |
| <p>1. YOUR ICON SHOCK ASSEMBLIES COME FACTORY CHARGED TO 250 PSI. RELEASING NITROGEN PRESSURE MAY LEAD TO SHOCK MALFUNCTION AND REDUCED RIDE QUALITY. FAILURE CAUSED BY LOW NITROGEN PRESSURE IS NOT COVERED UNDER ICON'S WARRANTY POLICY.</p> <p>2. BE CAUTIOUS WHEN LOWERING THE AXLE WITHOUT THE SHOCKS ATTACHED, THE BRAKE LINES CAN BECOME STRETCHED AND CAUSE DAMAGE.</p> <p>3. ESTIMATED INSTALL TIME: 1.5 HOURS</p> |  |



**WARNING!**

**\*\* READ ALL INSTRUCTIONS THOROUGHLY FROM START TO FINISH BEFORE BEGINNING INSTALLATION! IF THESE INSTRUCTIONS ARE NOT PROPERLY FOLLOWED SEVERE FRAME, SUSPENSION AND TIRE DAMAGE MAY RESULT TO THE VEHICLE!**

**\*\* ICON VEHICLE DYNAMICS RECOMMENDS THAT YOU EXERCISE EXTREME CAUTION WHEN WORKING UNDER A VEHICLE THAT IS SUPPORTED WITH JACK STANDS.**

**\*\* ICON VEHICLE DYNAMICS RECOMMENDS ALL INSTALLATION TO BE PERFORMED BY A PROFESSIONAL SHOP/SERVICE TECHNICIAN. PRODUCT FAILURE CAUSED BY IMPROPER INSTALLATION WILL NOT BE COVERED UNDER ICON'S WARRANTY POLICY.**

## INSTALLATION

1. Lift vehicle and securely place heavy duty jack stands under the manufacturer recommended lifting locations for the rear of the vehicle. Take care when lifting the vehicle and allow 3-4" of ground clearance from the tire. Remove front tires. NEVER WORK UNDER AN UNSUPPORTED VEHICLE. Remove the wheels.
2. Support the rear axle and remove the rear shocks.
3. Remove the upper nut using an 8mm to hold the stud and 19mm to remove the nut. [FIGURE 1]

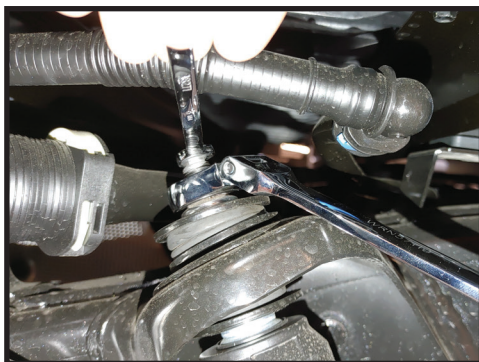


FIG.1

4. Remove the lower bolt using a 17mm. [FIGURE 2]



FIG.2

5. Install optional shock boot securing the top of the boot with the supplied zip-tie.

6. Install the new Icon stem bushings onto the Icon shock. Place the washer with the bigger hole on, then a bushing. Place the stem into the upper shock mount, then another bushing and the washer, thread on one of the supplied nuts, tighten it down until the second nut can on and 3-4 thread show with both nuts installed. [FIGURE 3]

FIG.3



7. Install the lower eyelet of the Icon shock onto the axle stud. Use the supplied sleeves to position the eyelet correctly. Sleeve, shock eyelet, sleeve. Use the factory bolt and torque to factory specs. [FIGURE 4 & 5]

FIG.4



FIG.5



8. For reservoir mounting, use the supplied reservoir bracket and hold the reservoir and bracket up to the frame as shown, and mark the hole to drill it to 11/32" (SHOCK APPEARANCE MAY CHANGE DUE TO ONGOING DEVELOPMENT). [FIGURE 6, 7, 8]

FIG.6



FIG.7



FIG.8



**9.** With the hole drilled, take the supplied 3/8" self-tap flanged bolt and reservoir bracket and install onto the frame.

**10.** Using the supplied hose clamps, clamp the reservoir onto the bracket as shown (If desired, the supplied heat shrink material can be cut to fit over the hose clamps). [FIGURE 9, 10, 11, 12]

FIG.9



FIG.10



FIG.11



FIG.12

**11.** With the shocks installed. Reinstall the wheels and tires, lower to the ground and torque the lug nuts to factory spec.

***VERIFY ALL FASTENERS ARE PROPERLY TORQUED BEFORE DRIVING VEHICLE.***

***RETORQUE ALL NUTS, BOLTS AND LUGS AFTER 100 MILES AND PERIODICALLY THEREAFTER.***

## 2.5 VS SERIES SHOCK & COILOVER TECHNICAL INFORMATION

### MAINTENANCE

ICON shock absorbers are a high quality rebuildable race style shock absorber designed for optimal performance. With a unit of this caliber on your vehicle, routine maintenance is required to keep them looking and operating in like new condition. Residual oil and assembly lube may be present at all seal paths from the factory out of the box and is considered normal. Pooling of oil however is not acceptable at any time and one should contact the ICON dealer where purchased.

**BELOW ARE GUIDELINES BASED ON HOW YOU USE YOUR VEHICLE BUT YOUR MILEAGE MAY VARY:**

#### **STREET USE:**

- Send in for factory servicing every 40,000 miles or if a leak develops, ride quality decreases, or they begin to make excessive noise.
- Remove any buildup of road salt, mud, or debris from shocks and coil springs anytime accrued
- Clean with mild soap and water with each oil change or anytime you notice build up.
- Wax the cylinders yearly with automotive wax to prevent corrosion.
- Check nitrogen pressure yearly. (252004 charge needle assembly available at any ICON distributor)
- Check bearings for excessive wear yearly.
- DO NOT apply any type of lube to the upper and lower bearings.

#### **STREET/DIRT:**

- Send in for factory servicing every 15,000 miles or if a leak develops, ride quality decreases, or they begin to make excessive noise.
- Clean with mild soap and water with each oil change, offroad trip, or anytime you notice build up.
- Wax the cylinders yearly with automotive wax to prevent corrosion.
- Check nitrogen pressure each dirt outing. (252004 charge needle assembly available at any ICON distributor)
- Check bearings for excessive wear yearly.
- DO NOT apply any type of lube to the upper and lower bearings.

#### **DIRT USE:**

- Send in for factory servicing every 1,000 miles.
- Check nitrogen pressure each outing. (252004 charge needle assembly available at any ICON distributor)
- Remove any buildup of mud or debris from shocks and coil springs after every outing.

#### **SELF-SERVICE:**

- Contact ICON for service kits & tools at (951) 689-4266.

### PRODUCT REGISTRATION

Please visit: <http://www.iconvehicledynamics.com/tech-support/registration/> to register your product.

### ICON VEHICLE DYNAMICS SHOCK ABSORBER WARRANTY

This shock absorber has a 1 year warranty against any manufacturer's defects. If a shock fails within the initial year of ownership, the shock must be shipped to ICON Vehicle Dynamics for inspection and service. If a shock is inspected and it has been determined the shock failed due to neglect, damage caused by improper installation or any other reason besides "normal wear and tear", the owner of said shock is responsible for all service costs. This includes labor, parts, and shipping.

ICON Vehicle Dynamics warrants to the original retail purchaser who owns the vehicle on which the product was originally installed. ICON Vehicle Dynamics does not warrant the product for finish, alterations, modifications and/or installation contrary to ICON Vehicle Dynamics instructions. ICON Vehicle Dynamics products are not designed, nor are they intended to be installed on vehicles used in race applications, for racing purposes or for similar activities. (A "race" is defined as any contest between two or more vehicles, or a contest of one or more vehicles against the clock, whether or not such contest is for a prize). This warranty does not include coverage for police or taxi vehicles, race vehicles, or vehicles used for government or commercial purposes. Also excluded from this warranty are sales outside of the United States of America and Canada.

ICON Vehicle Dynamics' obligation under this warranty is limited to the repair or replacement, at ICON Vehicle Dynamics' discretion, of the defective product. Any and all costs of removal, installation or re-installation, freight charges and incidental or consequential damages are expressly excluded from this warranty. Items that are subject to wear are not considered defective when worn and are not covered.

ICON Vehicle Dynamics components must be installed as a complete kit as shown in our current application guide. Any substitutions or exemptions of required components will immediately void the warranty. Some finish damage may happen to parts during shipping and is not covered under warranty.

This warranty is expressly in lieu of all other warranties expressed or implied. This warranty shall not apply to any product that has been improperly installed, modified or customized subject to accident, negligence, abuse or misuse.

To send a shock in for warranty please visit our website <http://www.iconvehicledynamics.com/tech-support/shock-service/>



**ICON VEHICLE DYNAMICS®**  
PERFORMANCE SUSPENSION SYSTEMS AND SHOCK ABSORBERS

7929 Lincoln Ave. Riverside, CA 92504 Phone: 951.689.ICON Fax: 951.689.1016  
[www.iconvehicledynamics.com](http://www.iconvehicledynamics.com)



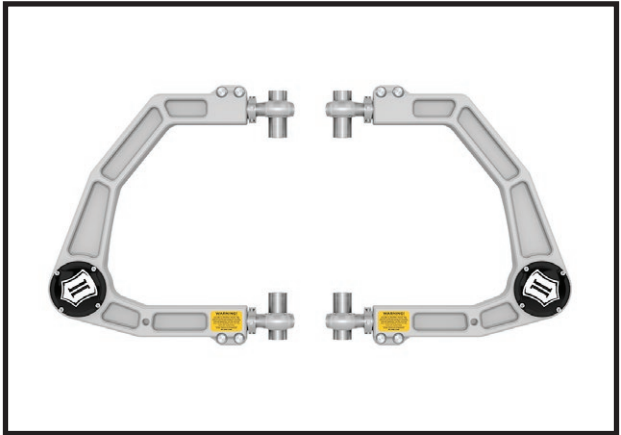
**FOLLOW US ON FACEBOOK!**



7929 Lincoln Ave. Riverside, CA 92504  
 Phone: 951.689.ICON | Fax: 951.689.1016

| PART #  | DESCRIPTION                        |
|---------|------------------------------------|
| 58561DJ | 22-UP TOYOTA TUNDRA BILLET UCA KIT |

| COMPONENTS INCLUDED  |   |
|--|---|
| (1) 157619 22-UP TUNDRA BILLET UCA DRVR  | (1) 157620 22-UP TUNDRA BILLET UCA PASS   |
| HARDWARE INCLUDED  |   |
| (4) 157509 HEIM SPACER JM12 X 16MM X 1.875 CZINC<br>(4) 157510 HEIM SPACER JM12 X 16MM X 2.875 CZINC   | (2) 297165 DELTA PRO BILLET UCA DUST COVER<br>(8) 605002 6-32 X 0.500 SHCS 18-8 RAW<br>(2) 605890 M14 FENDER WASHER 36MM OD<br>(1) 605968 VIBRATITE BLUE 2ML BULLET |
| TOOLS REQUIRED   |   |
| JACK<br>JACK STANDS<br>#2 PHILLIPS SCREWDRIVER<br>BODY CLIP REMOVAL TOOL<br>SMALL FLAT BLADE SCREWDRIVER<br>NEEDLE NOSE PLIERS<br>TORQUE WRENCH  | 10MM SOCKET / WRENCH<br>12MM SOCKET / WRENCH<br>19MM SOCKET / WRENCH<br>22MM SOCKET / WRENCH<br>3/8 12-PT   |
| TECH NOTES   |   |
| <p>1. DO NOT EXCEED 1.875" ADJUSTMENT FROM THE CENTER OF THE ROD END TO THE EDGE OF THE BILLET UPPER CONTROL ARM. FAILURE CAUSED BY EXCESSIVE ADJUSTMENT WILL NOT BE COVERED UNDER ICON'S WARRANTY POLICY. REFER TO TECH NOTE PHOTO.</p> <p>2. ICON DELTA JOINTS ARE PRE-GREASED FROM THE FACTORY. ICON RECOMMENDS GREASING THE DELTA JOINT EVERY 3,000 MILES (OR EVERY OIL CHANGE). ADD NEW GREASE UNTIL ALL OF THE OLD GREASE IS EXPELLED FROM THE BOTTOM OF THE DELTA JOINT ASSEMBLY, WIPE AWAY EXCESS WITH A RAG OR SHOP TOWEL.</p> <p>3. ALL ICON UPPER CONTROL ARMS HAVE BEEN ENGINEERED TO ALLOW FOR THE MOST POSSIBLE CASTER, WHILE STILL ALLOWING THE VEHICLE TO BE PROPERLY ALIGNED. NOTIFY YOUR PROFESSIONAL ALIGNMENT SHOP OF THIS INFORMATION SO THAT MAXIMUM RIDE QUALITY CAN BE ACHIEVED.</p> <p>4. ESTIMATED INSTALL TIME: 3 HOURS</p> |   |



**WARNING!**

**\*\* READ ALL INSTRUCTIONS THOROUGHLY FROM START TO FINISH BEFORE BEGINNING INSTALLATION! IF THESE INSTRUCTIONS ARE NOT PROPERLY FOLLOWED SEVERE FRAME, SUSPENSION AND TIRE DAMAGE MAY RESULT TO THE VEHICLE!**

**\*\* ICON VEHICLE DYNAMICS RECOMMENDS THAT YOU EXERCISE EXTREME CAUTION WHEN WORKING UNDER A VEHICLE THAT IS SUPPORTED WITH JACK STANDS.**

**\*\* ICON VEHICLE DYNAMICS RECOMMENDS ALL INSTALLATION TO BE PERFORMED BY A PROFESSIONAL SHOP/SERVICE TECHNICIAN. PRODUCT FAILURE CAUSED BY IMPROPER INSTALLATION WILL NOT BE COVERED UNDER ICON'S WARRANTY POLICY.**

**INSTALLATION**

- Lift vehicle and securely place heavy duty jack stands under the manufacturer recommended lifting locations for the front of the vehicle. Take care when lifting the vehicle, and allow 3-4" of ground clearance from the tire. Remove front tires. NEVER WORK UNDER AN UNSUPPORTED VEHICLE. Remove the wheels.
- Open the hood and disconnect the negative terminal on the battery using a 12mm and unplug the electrical connector.
- Unplug the electrical connector on the air intake tube. [FIGURE 1]

- Remove the airbox. Loosen the hose clamp with a #2 phillips screwdriver or 10mm on the air intake hose located closest to the engine. [FIGURE 2]



FIG.1

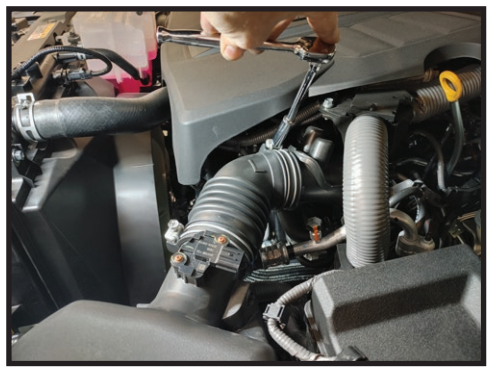


FIG.2

5. Lift up on box and remove. The box is only held in place by the intake tube and rubber grommets underneath.

6. With the box removed, remove the wiring clips from the ECU bracket. [FIGURE 3 & 4]

FIG.3

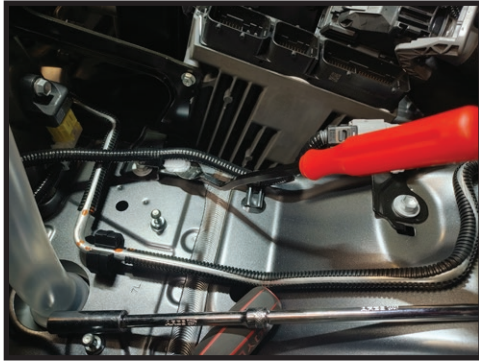


FIG.4



7. Unplug the small grey connector next to the ECU.

8. Unplug the ECU harnesses from the ECU. Push down on the safety latch and push the lever the opposite way. The connector will lift up and you will be able to remove it completely. [FIGURE 5 & 6]

FIG.5



FIG.6



9. Remove the harness clamp from the large wire loom using a small flat blade screwdriver. [FIGURE 7]

FIG.7



10. Remove the large harness from the ECU. Press lock clip and pull up on the grey lever and pulling plug out. [FIGURE 8]

FIG.8



**11.** Remove 3 10mm bolts from the ECU bracket. One on the front core support, two on the fender well. [FIGURE 9 & 10]

FIG.9

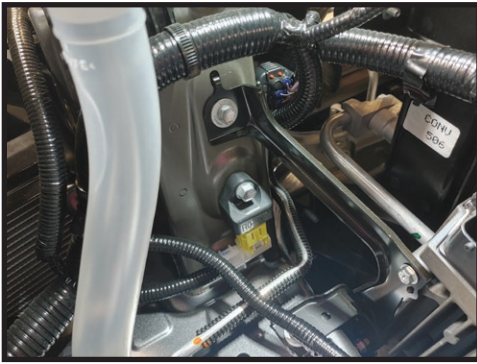
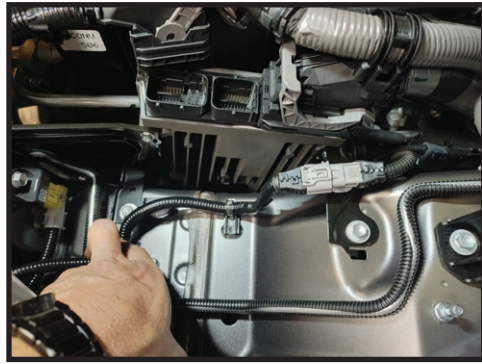


FIG.10



**12.** Remove the splash guards from the fender well using a needle nose pliers to pinch the clip and pull out. [FIGURE 11]

FIG.11



**13.** Remove the 12mm bolt from the top of the UCA that holds the ABS wire. [FIGURE 12]

FIG.12



**14.** Remove the cotter pin from the UCA balljoint using a small screwdriver or pick to pry over the safety clip and pull out the pin using a needle nose pliers. Loosen the 19mm nut on the balljoint. [FIGURE 13 & 14]

FIG.13



FIG.14



**15.** Use a hammer or balljoint separator to loosen the balljoint taper from the spindle. [FIGURE 15]

**FIG.15**



**16.** Loosen and remove the UCA pivot bolt from the frame using a 22mm. [FIGURE 16]

**FIG.16**



**17.** Remove the factory UCA. [FIGURE 17]

**FIG.17**



**18.** Prepare Icon Billet UCA for install. Be sure the heim spacers are correctly installed. Refer to photo. [FIGURE 18]

**FIG.18**



**19.** Install the ICON UCA into position and slide the factory mounting bolt through the heims, spacers and frame. [FIGURE 19 & 20]

FIG.19

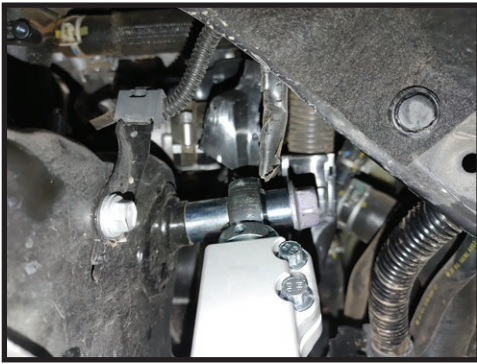
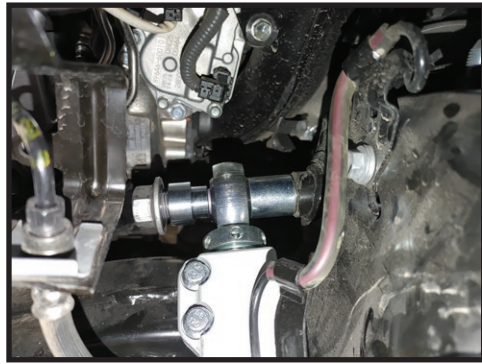


FIG.20



**20.** Install the Delta Joint Pro into the spindle, apply included blue thread locker to threads on flange nut and thread on to Delta Joint Pro with washer (605890) between the flange nut and spindle [Torque the nut to 70 ft-lbs]. [FIGURE 21]

FIG.21



**21.** Install the ABS bracket onto the Billet UCA using the factory bolt. [FIGURE 22]

FIG.22



**22.** Torque the factory long pivot bolt to OEM spec.

**23.** Install the supplied delta joint dust cap and o-ring using the four 6-32 x .500 stainless screws with a small amount of blue thread locker to the threads. [FIGURE 23]

FIG.23



- 24.** Reinstall the ECU and airbox in reverse order of removal.
- 25.** Repeat steps 12-21 on passenger side.
- 26.** Reinstall wheels and tires and carefully lower vehicle to the ground. Torque lug nuts to factory spec.

**[TECH NOTE #1]**



**VERIFY ALL FASTENERS ARE PROPERLY TORQUED BEFORE DRIVING VEHICLE.**

**RETORQUE ALL NUTS, BOLTS AND LUGS AFTER 100 MILES AND PERIODICALLY THEREAFTER.**

**ICON VEHICLE DYNAMICS LIMITED LIFETIME WARRANTY**

ICON Vehicle Dynamics warrants to the original retail purchaser who owns the vehicle on which the product was originally installed. ICON Vehicle Dynamics does not warrant the product for finish, alterations, modifications and/or installation contrary to ICON Vehicle Dynamics instructions. ICON Vehicle Dynamics products are not designed, nor are they intended to be installed on vehicles used in race applications, for racing purposes or for similar activities. (A "race" is defined as any contest between two or more vehicles, or a contest of one or more vehicles against the clock, whether or not such contest is for a prize). This warranty does not include coverage for police or taxi vehicles, race vehicles, or vehicles used for government or commercial purposes. Also excluded from this warranty are sales outside of the United States of America and Canada.

ICON Vehicle Dynamics' obligation under this warranty is limited to the repair or replacement, at ICON Vehicle Dynamics' discretion, of the defective product. Any and all costs of removal, installation or re-installation, freight charges and incidental or consequential damages are expressly excluded from this warranty. Items that are subject to wear are not considered defective when worn and are not covered.

ICON Vehicle Dynamics components must be installed as a complete kit as shown in our current application guide. Any substitutions or exemptions of required components will immediately void the warranty. Some finish damage may happen to parts during shipping and is not covered under warranty.

This warranty is expressly in lieu of all other warranties expressed or implied. This warranty shall not apply to any product that has been improperly installed, modified or customized subject to accident, negligence, abuse or misuse.



**ICON VEHICLE DYNAMICS®**  
PERFORMANCE SUSPENSION SYSTEMS AND SHOCK ABSORBERS

7929 Lincoln Ave. Riverside, CA 92504 Phone: 951.689.ICON Fax: 951.689.1016  
[www.iconvehicledynamics.com](http://www.iconvehicledynamics.com)



**FOLLOW US ON FACEBOOK!**



7929 Lincoln Ave. Riverside, CA 92504  
Phone: 951.689.ICON | Fax: 951.689.1016

| PART # | DESCRIPTION                         |
|--------|-------------------------------------|
| 58770C | 22-UP TUNDRA 2.5 VS RR COILOVER KIT |

### COMPONENTS INCLUDED

|  |  |
|--|--|
| (1) 154870CD 22-UP TUNDRA CO RR CDCV UPKG DRVR | (1) 154870CP 22-UP TUNDRA CO RR CDCV UPKG PASS |
|--|--|

### HARDWARE INCLUDED

|   |  |
|---|--|
| (2) 150122 22-UP TUNDRA 5/16 BUMP STOP SPACER<br>(1) 150126 22-UP TUNDRA FRONT RESI MOUNT DRVR<br>(1) 150127 22-UP TUNDRA FRONT RESI MOUNT PASS | (4) 605144 3/8-12 X .750 FLANGED SELF TAP BOLT CZINC<br>(1) 611025 07-22 TUNDRA CO HARDWARE KIT<br>(1) 611051 #36 1.188-2.750 STAINLESS HOSE CLAMP KIT (4) |
|---|--|

### TOOLS REQUIRED

|  |   |
|--|---|
| JACK<br>JACK STANDS<br>HAMMER<br>BALLJOINT SEPARATOR<br>FLAT BLADE SCREWDRIVER<br>PLIERS<br>TORQUE WRENCH<br>RATCHET<br>12 POINT AXLE SOCKET | 10MM SOCKET / WRENCH<br>12MM SOCKET / WRENCH<br>14MM SOCKET / WRENCH<br>19MM SOCKET / WRENCH<br>22MM SOCKET / WRENCH<br>24MM SOCKET / WRENCH<br>38MM SOCKET / WRENCH<br>9/16" SOCKET / WRENCH<br>5/16" NUT DRIVER |
|--|---|

### TECH NOTES

1. YOUR ICON COILOVER ASSEMBLIES COME FACTORY CHARGED TO 150 PSI. RELEASING NITROGEN PRESSURE MAY LEAD TO SHOCK MALFUNCTION AND REDUCED RIDE QUALITY. FAILURE CAUSED BY LOW NITROGEN PRESSURE IS NOT COVERED UNDER ICON'S WARRANTY POLICY.
2. YOUR ICON COILOVER ASSEMBLIES COME SHIPPED AT ICON'S RECOMMENDED RIDE HEIGHT. REDUCING DROOP TRAVEL WILL REDUCE RIDE QUALITY. DO NOT PRELOAD THE COIL BEYOND 1.125" OF EXPOSED THREADS BETWEEN THE BOTTOM OF THE TOP CAP AND THE TOP OF THE COIL ADJUSTER NUT. ADJUSTING PRELOAD BEYOND THIS SETTING WILL CAUSE THE COIL TO BIND AND DAMAGE WILL OCCUR TO COILOVER AND/OR VEHICLE.
3. ICON DOES NOT RECOMMEND LIFTING APPROXIMATELY 2.25" OF LIFT WITHOUT AN ICON UPPER CONTROL ARM (PN: 58461DJ OR 58561DJ). FAILURE TO DO SO CAN CAUSE DAMAGE TO AXLES.
4. FOR NON TRD MODELS, ICON RECOMMENDS USING ICON DIFF DROP (PN: 55156) OR USING TOYOTA TRD AXLES (PN: 434200C020-DRIVER, PN: 434100C020-PASSENGER). FAILURE TO DO SO COULD RESULT IN AXLE DAMAGE.
5. INSTALL TIME: 5-6 HOURS.



### WARNING!

**\*\* READ ALL INSTRUCTIONS THOROUGHLY FROM START TO FINISH BEFORE BEGINNING INSTALLATION! IF THESE INSTRUCTIONS ARE NOT PROPERLY FOLLOWED SEVERE FRAME, SUSPENSION AND TIRE DAMAGE MAY RESULT TO THE VEHICLE!**

**\*\* ICON VEHICLE DYNAMICS RECOMMENDS THAT YOU EXERCISE EXTREME CAUTION WHEN WORKING UNDER A VEHICLE THAT IS SUPPORTED WITH JACK STANDS.**

**\*\* ICON VEHICLE DYNAMICS RECOMMENDS ALL INSTALLATION TO BE PERFORMED BY A PROFESSIONAL SHOP/SERVICE TECHNICIAN. PRODUCT FAILURE CAUSED BY IMPROPER INSTALLATION WILL NOT BE COVERED UNDER ICON'S WARRANTY POLICY.**

2. Disconnect the sway bar link from the lower arm using a 19mm. Use a dead blow hammer to remove the link from the stud on the lower arm. Reinsert the bolt into the arm to keep track of it. [FIGURE 1]

## INSTALLATION

1. Lift vehicle and securely place heavy duty jack stands under the manufacturer recommended lifting locations for the front of the vehicle. Take care when lifting the vehicle, and allow 3-4" of ground clearance from the tire. Remove front tires. NEVER WORK UNDER AN UNSUPPORTED VEHICLE. Remove the wheels.

FIG.1



**3.** Loosen and remove the nut of the upper portion of the link using a 19mm. Remove the link from the swaybar and set aside with the nut.

**4.** Remove the (2) 12mm bolts that hold the brake line and abs bracket to the spindle. [FIGURE 2]

FIG.2



**5.** Remove the brake caliper from the spindle using a 19mm. Once removed, use a strap or rope to support the caliper so it does not hang by the brake line. Remove the brake rotor and set aside. [FIGURE 3 & 4]

FIG.3

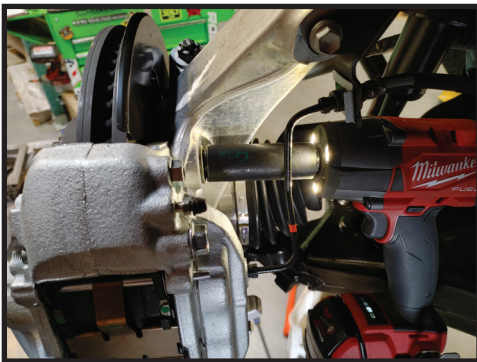
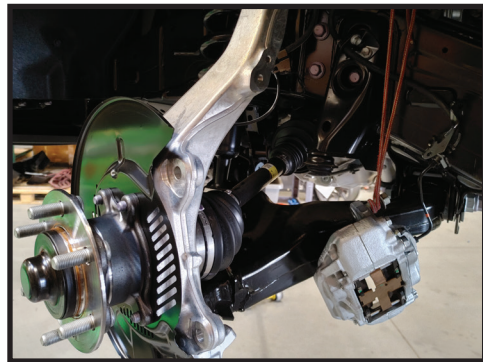
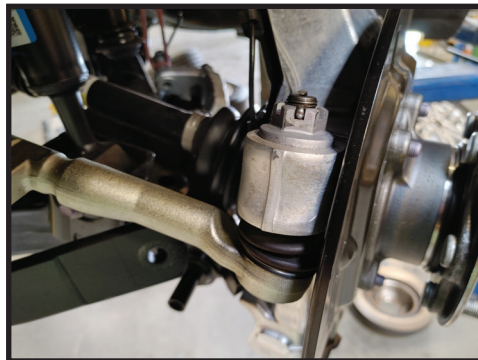


FIG.4



**6.** Use a pliers to remove the cotter pin from the tie rod nut/stud. Remove the tie rod nut using a 24mm. [FIGURE 5]

FIG.5



**7.** Use a ball joint separator or a hammer to loosen the tie rod stud taper from the spindle. [FIGURE 6]

FIG.6



**8.** Remove the wheel speed sensor from the front side of the spindle using a 10mm. Remove the bracket from the spindle using a 12mm. [FIGURE 7 & 8]

FIG.7



FIG.8



**9.** Remove the hub cap from the hub using a flat blade screwdriver to pry it away and off. [FIGURE 9 & 10]

FIG.9

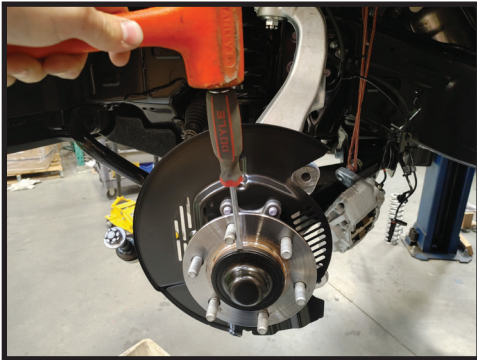
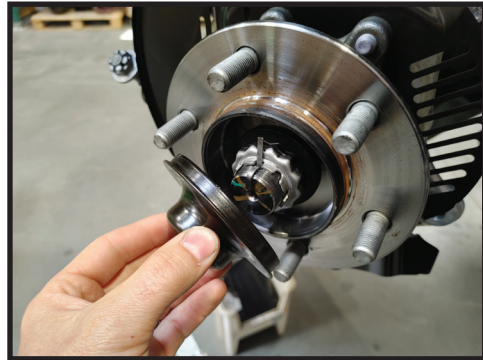


FIG.10



**10.** Use a pliers to remove the cotter pin holding the nut lock plate in place. [FIGURE 11]

FIG.11



**11.** Use a 38mm 12-point socket on an impact wrench to remove the axle nut. [FIGURE 12]

FIG.12



**12.** Use a dead blow hammer to hit the stub axle free of the hub. It won't come completely out of the hub yet.

**13.** Remove the cotter pin from the upper control arm stud/nut.

**14.** Use a 19mm to loosen the upper control arm ball joint nut. [FIGURE 13]

**FIG.13**



**15.** Use a balljoint separator or a hammer to loosen the balljoint taper from the spindle. Once loose, remove the nut and support the spindle so it does not fall free. [FIGURE 14]

**FIG.14**

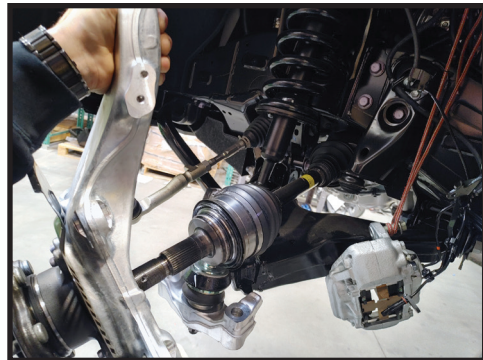


**16.** Use a 22mm to remove the 2 bolts from the bottom side of the spindle. Remove spindle being sure the stub axle comes out of the spindle. [FIGURE 15 & 16]

**FIG.15**

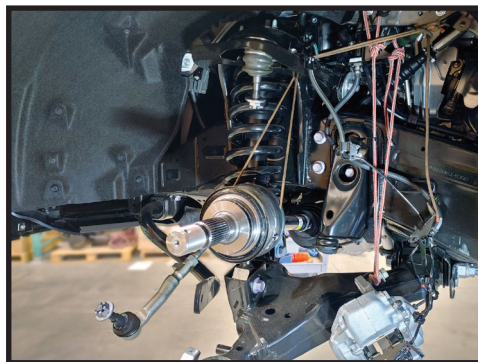


**FIG.16**



**17.** Use a rope or strap to support the cv/axle assembly out of the way. [FIGURE 17]

**FIG.17**



**18.** Support lower control arm and loosen the pivot bolts at the frame using a 24mm.

**19.** Remove the lower shock bolt using a 22mm. [FIGURE 18]

**FIG.18**



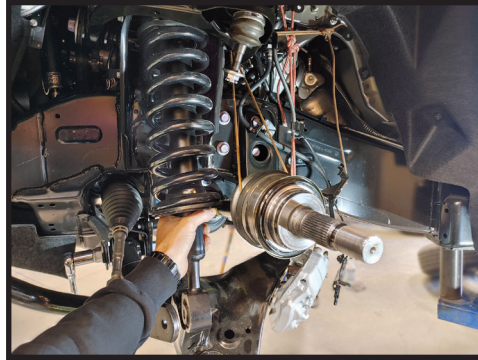
**20.** Remove upper shock mount nuts using a 14mm. [FIGURE 19]

**FIG.19**



**21.** Lower the control arm and remove the coilover assembly. [FIGURE 20]

**FIG.20**



**22.** Grind/cut the lower shock pocket on the control arm to add clearance for the new ICON coilover assembly. Removing the control arm can help make this easier. If removed, be sure the bolts go back into the same place and orientation. After cutting is complete, paint over the raw metal to prevent rust. [FIGURE 21 & 22]

**FIG.21**



**FIG.22**



**23.** Reinstall the control arm now, if removed.

**24.** Install the new ICON coilover, lower eyelet first with the spacers, then the upper mount. Torque the upper bolts to 35 ft-lbs, and the lower bolt to factory spec. [FIGURE 23 & 24]

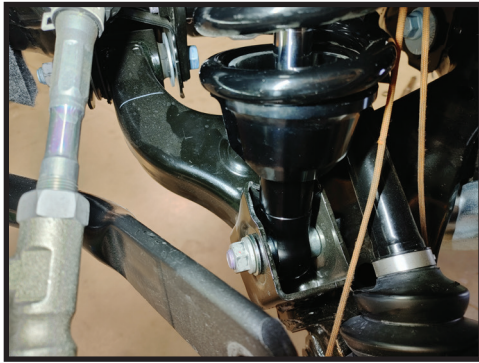


FIG.23



FIG.24

**25.** Remove the front rubber splash guard using a needle nose pliers to pinch and pull the clips out. 3 on driver side and 4 on passenger side. [FIGURE 25]



FIG.25

**26.** With the splash guard removed. Locate the reservoir bracket in the box along with 2 self threading 3/8 x 1" screws. Attach the bracket using the screws into the 2 frame holes that the splash guard used. The brackets have a slight bend in them that faces out to clear the fender well. Use the supplied hose clamps to secure the reservoir to the bracket. [FIGURE 26 & 27]



FIG.26



FIG.27

**27.** If an ICON UCA was purchased, install that now.

**28.** Reinstall spindle, insert the stub axle back into the hub, making sure the splines are aligned. Insert the lower 2 bolts into the spindle.

**29.** Install the upper control arm balljoint into the spindle and secure with the nut.

**30.** Torque the lower balljoint bolts to factory spec. Torque the upper balljoint to factory spec if using the OEM arm, or 70 ft-lbs for ICON Delta Joint Pro.

**31.** Install the axle nut and torque to factory spec. Install nut lock plate and cotter pin. Then use a dead blow hammer to install the hub cap.

**32.** Install rotor onto hub and install brake caliper back onto spindle. [Torque bolts to factory spec]

**33.** Reconnect brake line and ABS brackets onto spindle.

**34.** Install ABS sensor back into the spindle and the bracket.

**35.** When lifting above 2.25" install (PN: 55154, sold separately). Remove the sway bar mounting bracket from the frame using a 17mm and install the new drop spacers between the bracket and frame. Reinstall with the new bolts and torque to factory spec. [FIGURE 28 & 29]



FIG.28



FIG.29

**36.** If installing (PN: 55155) Icon sway bar end links, do so using Step 37.

**37.** Install new ICON sway bar links, the rod end side with supplied hi-misalignment spacers onto the sway bar using the supplied 9/16" bolt, washer only on the sway bar side and nut. 13/16" bolt head and 7/8" nut. Torque to 80 ft-lbs. [FIGURE 30]

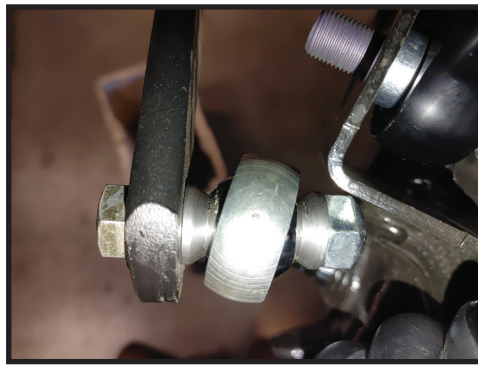


FIG.30

**38.** Install the lower end of the sway bar link onto the lower control arm stud. First the sleeve, then the link and second sleeve. Reuse the factory bolt and torque to factory spec. [FIGURE 31 & 32]

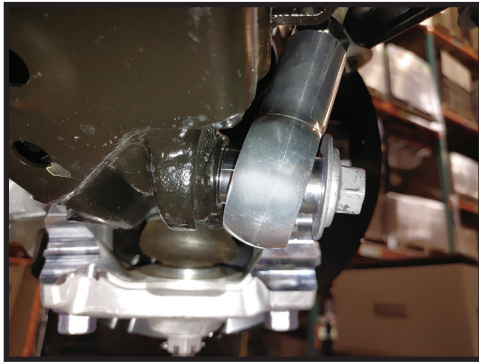


FIG.31



FIG.32

**39.** Install tie rod and nut. Torque to factory spec and reinstall cotter pin.

**40.** Remove factory bump stop from the frame and install the supplied 5/16" thick washer between the bump stop and frame. Apply thread locker to the threads of the bump stop and tighten back onto the frame. [FIGURE 33]



FIG.33

41. Repeat steps on opposite side.
42. Install wheels and tires, lower vehicle to the ground. Torque lug nuts.
43. Get vehicle professionally aligned.

**VERIFY ALL FASTENERS ARE PROPERLY TORQUED BEFORE DRIVING VEHICLE.**

**RETORQUE ALL NUTS, BOLTS AND LUGS AFTER 100 MILES AND PERIODICALLY THEREAFTER.**

## 2.5 VS SERIES SHOCK & COILOVER TECHNICAL INFORMATION

### MAINTENANCE

ICON shock absorbers are a high quality rebuildable race style shock absorber designed for optimal performance. With a unit of this caliber on your vehicle, routine maintenance is required to keep them looking and operating in like new condition. Residual oil and assembly lube may be present at all seal paths from the factory out of the box and is considered normal. Pooling of oil however is not acceptable at any time and one should contact the ICON dealer where purchased.

**BELOW ARE GUIDELINES BASED ON HOW YOU USE YOUR VEHICLE BUT YOUR MILEAGE MAY VARY:**

#### STREET USE:

- Send in for factory servicing every 40,000 miles or if a leak develops, ride quality decreases, or they begin to make excessive noise.
- Remove any buildup of road salt, mud, or debris from shocks and coil springs anytime accrued
- Clean with mild soap and water with each oil change or anytime you notice build up.
- Wax the cylinders yearly with automotive wax to prevent corrosion.
- Check nitrogen pressure yearly. (252004 charge needle assembly available at any ICON distributor)
- Check bearings for excessive wear yearly.
- DO NOT apply any type of lube to the upper and lower bearings.

#### STREET/DIRT:

- Send in for factory servicing every 15,000 miles or if a leak develops, ride quality decreases, or they begin to make excessive noise.
- Clean with mild soap and water with each oil change, offroad trip, or anytime you notice build up.
- Wax the cylinders yearly with automotive wax to prevent corrosion.
- Check nitrogen pressure each dirt outing. (252004 charge needle assembly available at any ICON distributor)
- Check bearings for excessive wear yearly.
- DO NOT apply any type of lube to the upper and lower bearings.

#### DIRT USE:

- Send in for factory servicing every 1,000 miles.
- Check nitrogen pressure each outing. (252004 charge needle assembly available at any ICON distributor)
- Remove any buildup of mud or debris from shocks and coil springs after every outing.

#### SELF-SERVICE:

- Contact ICON for service kits & tools at (951) 689-4266.

### PRODUCT REGISTRATION

Please visit: <http://www.iconvehicledynamics.com/tech-support/registration/> to register your product.

### ICON VEHICLE DYNAMICS SHOCK ABSORBER WARRANTY

This shock absorber has a 1 year warranty against any manufacturer's defects. If a shock fails within the initial year of ownership, the shock must be shipped to ICON Vehicle Dynamics for inspection and service. If a shock is inspected and it has been determined the shock failed due to neglect, damage caused by improper installation or any other reason besides "normal wear and tear", the owner of said shock is responsible for all service costs. This includes labor, parts, and shipping.

ICON Vehicle Dynamics warrants to the original retail purchaser who owns the vehicle on which the product was originally installed. ICON Vehicle Dynamics does not warrant the product for finish, alterations, modifications and/or installation contrary to ICON Vehicle Dynamics instructions. ICON Vehicle Dynamics products are not designed, nor are they intended to be installed on vehicles used in race applications, for racing purposes or for similar activities. (A "race" is defined as any contest between two or more vehicles, or a contest of one or more vehicles against the clock, whether or not such contest is for a prize). This warranty does not include coverage for police or taxi vehicles, race vehicles, or vehicles used for government or commercial purposes. Also excluded from this warranty are sales outside of the United States of America and Canada.

ICON Vehicle Dynamics' obligation under this warranty is limited to the repair or replacement, at ICON Vehicle Dynamics' discretion, of the defective product. Any and all costs of removal, installation or re-installation, freight charges and incidental or consequential damages are expressly excluded from this warranty. Items that are subject to wear are not considered defective when worn and are not covered.

ICON Vehicle Dynamics components must be installed as a complete kit as shown in our current application guide. Any substitutions or exemptions of required components will immediately void the warranty. Some finish damage may happen to parts during shipping and is not covered under warranty.

This warranty is expressly in lieu of all other warranties expressed or implied. This warranty shall not apply to any product that has been improperly installed, modified or customized subject to accident, negligence, abuse or misuse.

To send a shock in for warranty please visit our website <http://www.iconvehicledynamics.com/tech-support/shock-service/>



**ICON VEHICLE DYNAMICS®**  
PERFORMANCE SUSPENSION SYSTEMS AND SHOCK ABSORBERS

7929 Lincoln Ave. Riverside, CA 92504 Phone: 951.689.ICON Fax: 951.689.1016  
[www.iconvehicledynamics.com](http://www.iconvehicledynamics.com)



**FOLLOW US ON FACEBOOK!**

