

7929 Lincoln Ave. Riverside, CA 92504
Phone: 951.689.ICON | Fax: 951.689.1016

PART #	DESCRIPTION
53508	22-UP TUNDRA IIC KIT

COMPONENTS INCLUDED	
(1) 254409 22-UP TUNDRA IIC MOUNT (1) 255600 IIC CONTROLLER (1) 255601 BLOCK OFF PLUG (1) 255602 WIRE HARNESS	(1) 255605-10 INLINE ATO FUSE HOLDER W/10 AMP FUSE (1) 255607 FUSE TAP LOW PROFILE MINI
HARDWARE INCLUDED	
(2) 605033 SELF DRILL SCREW (2) 605069 1/4-20 X 1.25 BOLT (2) 605750 BUTT CONNECTOR (3) 605751 5/16 TERMINAL CONNECTOR (1) 605753 LOW PROFILE MINI FUSE 2 AMP	(1) 605760 WIRE LOOM 1/4" X 6FT (1) 605926-BLK-100 BLACK NYLON CABLE TIE 100PK (2) 605984 RUBBER STRIP 1" X 3" ADHESIVE BACK
WIRES INCLUDED WITH FRONT SHOCKS	
PASS FRONT: (1) 255604-04 4-FT WIRE	DRIVER FRONT: (1) 255604-08 8-FT WIRE
WIRES INCLUDED WITH REAR SHOCKS	
PASS REAR: (1) 255604-16 16-FT WIRE	DRIVER REAR: (1) 255604-20 20-FT WIRE
TOOLS REQUIRED	
WIRE CUTTERS WIRE STRIPPER WIRE CRIMPERS FLUSH CUTS PHILLIPS HEAD SCREWDRIVER	HEAT GUN TORQUE WRENCH 10MM SOCKET / WRENCH 12MM SOCKET / WRENCH 7/16" SOCKET / WRENCH
TECH NOTES	
1. WIRE LENGTHS ARE MEASURED FOR V6, CREW CAB, SHORT BED.	
2. GOLD WIRE COLOR IN FIGURES DENOTES BASIC WIRE PATH (FOR CLARITY).	
3. SEE PAGE 8 FOR WIRE ROUTING DIAGRAM.	
FUSE OPTIONS	
S/HTR F/L (15A)	

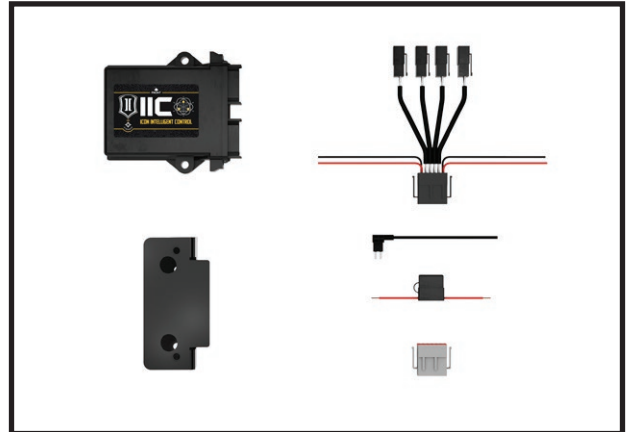

WARNING!

**** READ ALL INSTRUCTIONS THOROUGHLY FROM START TO FINISH BEFORE BEGINNING INSTALLATION! IF THESE INSTRUCTIONS ARE NOT PROPERLY FOLLOWED SEVERE FRAME, SUSPENSION AND TIRE DAMAGE MAY RESULT TO THE VEHICLE!**

**** ICON VEHICLE DYNAMICS RECOMMENDS THAT YOU EXERCISE EXTREME CAUTION WHEN WORKING UNDER A VEHICLE THAT IS SUPPORTED WITH JACK STANDS.**

**** ICON VEHICLE DYNAMICS RECOMMENDS ALL INSTALLATION TO BE PERFORMED BY A PROFESSIONAL SHOP/SERVICE TECHNICIAN. PRODUCT FAILURE CAUSED BY IMPROPER INSTALLATION WILL NOT BE COVERED UNDER ICON'S WARRANTY POLICY.**

INSTALLATION

1. Disconnect the Battery using a 10mm.
2. Unclip the fender shroud from the passenger side fender but pulling straight up. Be careful not to damage the clips. [FIGURE 1]



FIG.1

3. Place the IIC mount (PN 254409) as shown. Line up with the inner edge of the mounting surface. Mark the location of the rear most hole with a marker. Remove the mount. [FIGURE 2]



FIG.2

4. Use the supplied self-drilling hardware (PN 605066) to drill and thread a hole in the marked location. Remove the hardware and position the mount. Fasten the mount using the rear screw. With the mount fastened in place, drill the forward most hole self-drilling hardware. Torque both screws to 45 in-lbs. [FIGURE 3]

FIG.3



5. Place the 2 adhesive strips (PN 605984) on the mount as shown. [FIGURE 4]

FIG.4



6. Position the IIC and start the rear mounting bolt. Rotate the IIC out from under the fender. Plug in the grey block off plug (PN 255601) to the grey port. Plug in the main wire harness (PN 255602) to the black port as shown. Route all wires under the mount. [FIGURE 5]

FIG.5



7. Rotate the IIC into position and fasten using the supplied hardware. Torque to 15 ft-lbs. using a 7/16. [FIGURE 6]

FIG.6



WIRE CONNECTIONS

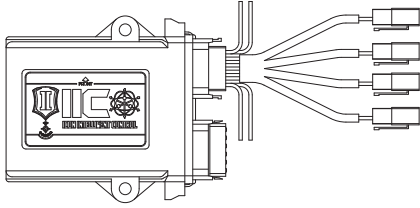

PLUG	POSITION	WIRE LENGTH	PART #
#4	DRIVER FRONT	8-FT WIRE	255064-08
#3	PASSENGER FRONT	4-FT WIRE	255064-04
#2	DRIVER REAR	20-FT WIRE	255064-20
#1	PASSENGER REAR	16-FT WIRE	255064-16

8. Carefully trim the fender shroud to fit around the IIC and mount. Replace the fender shroud. [FIGURE 7]

FIG.7



9. Route the 2 black ground wires to the ground connection under the IIC mount on the fender. Cut to length, strip, and crimp the terminal connectors (PN 605751) on. Use a heat gun to activate heat shrink. Connect to the fender ground using a 10mm. [FIGURE 8]

FIG.8



10. Route the red ACC (ACCESSORY) wire down to the wire loom at the base of the fuse box. Feed the red AAC (ACCESSORY) wire up into the fuse box. [FIGURE 9]

FIG.9



- 11.** Locate the supplied fuse tap (PN 255607) and low-profile mini fuse. Insert the supplied fuse into the lower fuse slot on the fuse tap. Locate the S/HTR F/L fuse. Remove the S/HTR F/L fuse and insert it into the upper slot on the fuse tap.
- 12.** Insert the fuse tap in the original location of the S/HTR F/L fuse.
- 13.** Use the supplied butt connector (PN 605750) to connect the fuse tap to the red ACC (ACCESSORY) wire. Use a heat gun to activate heat shrink. [FIGURE 10 & 10B]

FIG.10

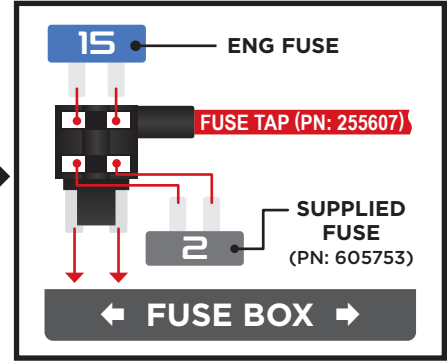
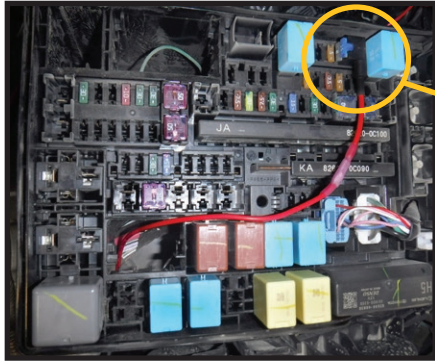
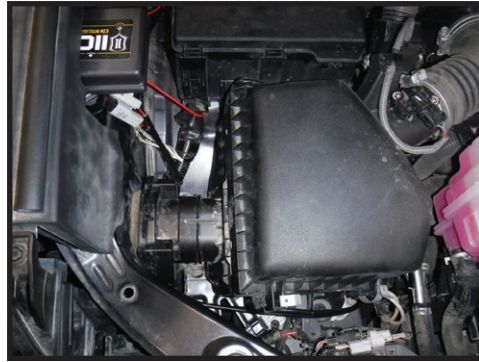

FIG.10B

- 14.** Route the 4-ft wire and 8-ft wire under the air cleaner and down into the engine bay in front of the air cleaner. Zip-tie as you go. [FIGURE 11]

FIG.11



- 15.** Route the 4-ft wire over the frame rail to the passenger side front shock. [FIGURE 12]

FIG.12



16. Route the 8-ft wire down and across the bottom of the radiator to the driver side. Route the wire up and over the frame rail to the driver side front shock. [FIGURE 13, 14, 15]

FIG.13



FIG.14



FIG.15



17. Route the 16-ft and 20-ft wires down between the fuse box and the battery. Then route them down into the engine bay. [FIGURE 16]

FIG.16



18. Route the wires along the brake lines down to the frame rail. [FIGURE 17 & 18]

FIG.17



FIG.18



19. Rout the wires along the frame rail following the brake lines. [FIGURE 19 & 20]

FIG.19



FIG.20



20. Route the wires along the wire harness to the passenger rear shock. Route the 16-ft wire to the passenger side rear shock reservoir. [FIGURE 21 & 22]

FIG.21



FIG.22



21. Route the 20-ft wire across the crossmember following the wire harness to the driver side rear shock. Continue to the driver side rear shock reservoir. [FIGURE 23, 24, 25]

FIG.23



FIG.24



FIG.25



22. Reconnect the battery using a 10mm.

23. Download the ICON INTELLIGENT CONTROL App on your device. Open the app and turn on the vehicle.

**VERIFY ALL FASTENERS ARE PROPERLY TORQUED BEFORE DRIVING VEHICLE.
RETORQUE ALL NUTS, BOLTS AND LUGS AFTER 100 MILES AND PERIODICALLY THEREAFTER.**

ICON VEHICLE DYNAMICS LIMITED LIFETIME WARRANTY

ICON Vehicle Dynamics warrants to the original retail purchaser who owns the vehicle on which the product was originally installed. ICON Vehicle Dynamics does not warrant the product for finish, alterations, modifications and/or installation contrary to ICON Vehicle Dynamics instructions. ICON Vehicle Dynamics products are not designed, nor are they intended to be installed on vehicles used in race applications, for racing purposes or for similar activities. (A "race" is defined as any contest between two or more vehicles, or a contest of one or more vehicles against the clock, whether or not such contest is for a prize). This warranty does not include coverage for police or taxi vehicles, race vehicles, or vehicles used for government or commercial purposes. Also excluded from this warranty are sales outside of the United States of America and Canada.

ICON Vehicle Dynamics' obligation under this warranty is limited to the repair or replacement, at ICON Vehicle Dynamics' discretion, of the defective product. Any and all costs of removal, installation or re-installation, freight charges and incidental or consequential damages are expressly excluded from this warranty. Items that are subject to wear are not considered defective when worn and are not covered.

ICON Vehicle Dynamics components must be installed as a complete kit as shown in our current application guide. Any substitutions or exemptions of required components will immediately void the warranty. Some finish damage may happen to parts during shipping and is not covered under warranty.

This warranty is expressly in lieu of all other warranties expressed or implied. This warranty shall not apply to any product that has been improperly installed, modified or customized subject to accident, negligence, abuse or misuse.



ICON VEHICLE DYNAMICS®
PERFORMANCE SUSPENSION SYSTEMS AND SHOCK ABSORBERS

7929 Lincoln Ave. Riverside, CA 92504 Phone: 951.689.ICON Fax: 951.689.1016
www.iconvehicledynamics.com



FOLLOW US ON FACEBOOK!



WIRE ROUTING DIAGRAM: 2022 Tundra

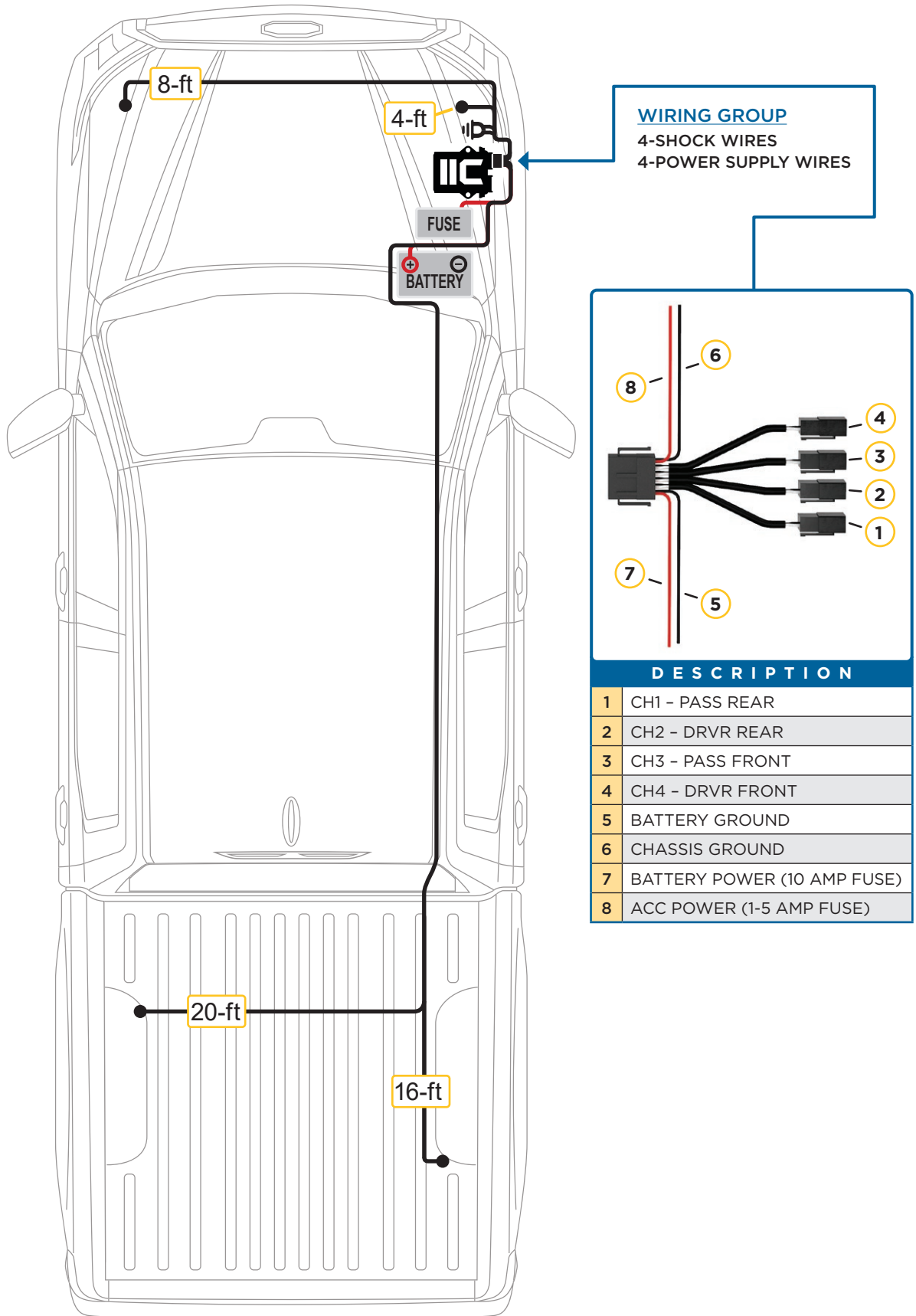

7929 Lincoln Ave. Riverside, CA 92504
Phone: 951.689.ICON | Fax: 951.689.1016

PART #	DESCRIPTION
54002	22-UP TUNDRA BILLET LOWER LINK KIT

COMPONENTS INCLUDED	
(2) 157552 22-UP TUNDRA REAR LOWER LINK (2) 157546 22-UP TUNDRA SERRATED SPACER .259 (2) 157548 22-UP TUNDRA SERRATED SLEEVE .259 (2) 157420 NUT PLATE 3/8-16 X 2 (4) 157551 HEIM SPACER 1.00 X .559 X 2.834	(2) 167014 L/R ADJUSTER SLEEVE 1.25-12L / 1.00-14 (2) 127205 16.6" TRAILING ARM WEAR STRIP (2) 295510 JM16-1T 1-14 RH ROD END F2 FIT (2) 297102 GREASELESS PRESS IN BUSHING 2.135 X 14.3 X 58.85MM
HARDWARE INCLUDED	
(14) 605018 10-32 X .438 FLAT HEAD SCREW STAINLESS	(4) 605146 3/8-16 X 1.5 12 PT FLANGED CAP SCREW
TOOLS REQUIRED	
JACK JACK STANDS TORQUE WRENCH	19MM SOCKET / WRENCH 3/8 12-PT SOCKET / WRENCH
TECH NOTES	
<p>1. DO NOT EXCEED 3.375" ADJUSTMENT FROM THE CENTER OF THE ROD END TO THE EDGE OF THE BILLET LINK. FAILURE CAUSED BY EXCESSIVE ADJUSTMENT WILL NOT BE COVERED UNDER ICON'S WARRANTY POLICY.</p> <p>2. LINKS ARE PRESET TO 26.938" (FACTORY LENGTH).</p> <p>3. IF CUSTOM PINION ANGLE IS DESIRED YOU CAN ADJUST THIS WITH THE VEHICLE ON THE GROUND.</p>	

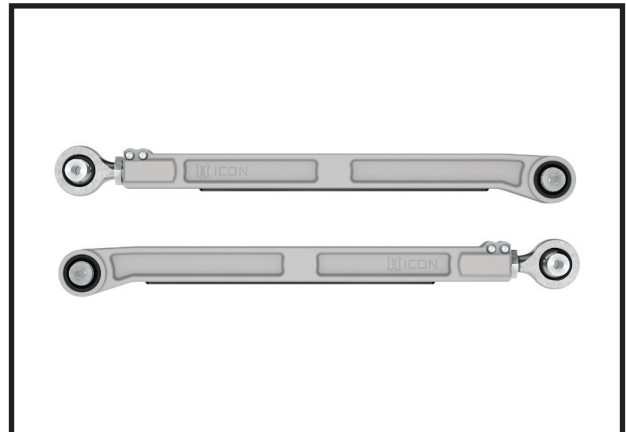

WARNING!
<p>** READ ALL INSTRUCTIONS THOROUGHLY FROM START TO FINISH BEFORE BEGINNING INSTALLATION! IF THESE INSTRUCTIONS ARE NOT PROPERLY FOLLOWED SEVERE FRAME, SUSPENSION AND TIRE DAMAGE MAY RESULT TO THE VEHICLE!</p> <p>** ICON VEHICLE DYNAMICS RECOMMENDS THAT YOU EXERCISE EXTREME CAUTION WHEN WORKING UNDER A VEHICLE THAT IS SUPPORTED WITH JACK STANDS.</p> <p>** ICON VEHICLE DYNAMICS RECOMMENDS ALL INSTALLATION TO BE PERFORMED BY A PROFESSIONAL SHOP/SERVICE TECHNICIAN. PRODUCT FAILURE CAUSED BY IMPROPER INSTALLATION WILL NOT BE COVERED UNDER ICON'S WARRANTY POLICY.</p>

INSTALLATION

1. Lift vehicle and securely place heavy duty jack stands under the manufacturer recommended lifting locations for the back of the vehicle. NEVER WORK UNDER AN UNSUPPORTED VEHICLE. Remove the wheels.

2. Remove the driver side rear upper link using a 19mm. [FIGURE 1]



FIG.1

3. Install the billet link with the heim joint toward the frame and the pinch bolts up. The pinch bolts should be on the outer side of the link. Tighten the factory hardware to factory spec using a 19mm. [FIGURE 2]



FIG.2

4. Repeat steps on opposite side of vehicle.
5. To adjust, loosen the pinch bolts billet link using a 3/8" 12pt. Turn the L/R adjusting collar until desired length is reached.
6. Make sure that the slit in the collar is lined up with the slit in the pinch housing and tighten pinch bolts using an alternating pattern [Torque to 40 ft-lbs]. Go back and forth between bolts 3 times to torque equally.
7. Never exceed the maximum length as listed in the tech notes

[TECH NOTE #1]



VERIFY ALL FASTENERS ARE PROPERLY TORQUED BEFORE DRIVING VEHICLE.

RETORQUE ALL NUTS, BOLTS AND LUGS AFTER 100 MILES AND PERIODICALLY THEREAFTER.

ICON VEHICLE DYNAMICS LIMITED LIFETIME WARRANTY

ICON Vehicle Dynamics warrants to the original retail purchaser who owns the vehicle on which the product was originally installed. ICON Vehicle Dynamics does not warrant the product for finish, alterations, modifications and/or installation contrary to ICON Vehicle Dynamics instructions. ICON Vehicle Dynamics products are not designed, nor are they intended to be installed on vehicles used in race applications, for racing purposes or for similar activities. (A "race" is defined as any contest between two or more vehicles, or a contest of one or more vehicles against the clock, whether or not such contest is for a prize). This warranty does not include coverage for police or taxi vehicles, race vehicles, or vehicles used for government or commercial purposes. Also excluded from this warranty are sales outside of the United States of America and Canada.

ICON Vehicle Dynamics' obligation under this warranty is limited to the repair or replacement, at ICON Vehicle Dynamics' discretion, of the defective product. Any and all costs of removal, installation or re-installation, freight charges and incidental or consequential damages are expressly excluded from this warranty. Items that are subject to wear are not considered defective when worn and are not covered.

ICON Vehicle Dynamics components must be installed as a complete kit as shown in our current application guide. Any substitutions or exemptions of required components will immediately void the warranty. Some finish damage may happen to parts during shipping and is not covered under warranty.

This warranty is expressly in lieu of all other warranties expressed or implied. This warranty shall not apply to any product that has been improperly installed, modified or customized subject to accident, negligence, abuse or misuse.



ICON VEHICLE DYNAMICS®
PERFORMANCE SUSPENSION SYSTEMS AND SHOCK ABSORBERS

7929 Lincoln Ave. Riverside, CA 92504 Phone: 951.689.ICON Fax: 951.689.1016
www.iconvehicledynamics.com



FOLLOW US ON FACEBOOK!



7929 Lincoln Ave. Riverside, CA 92504
Phone: 951.689.ICON | Fax: 951.689.1016

PART #	DESCRIPTION
54102	22-UP TUNDRA BILLET UPPER LINK KIT

COMPONENTS INCLUDED	
(2) 157553 22-UP TUNDRA REAR UPPER LINK (2) 157547 22-UP TUNDRA SERRATED SPACER .200 (2) 157549 22-UP TUNDRA SERRATED SLEEVE .200 (2) 157420 NUT PLATE 3/8-16 X 2 (4) 157551 HEIM SPACER 1.00 X .559 X 2.834	(2) 167014 L/R ADJUSTER SLEEVE 1.25-12L / 1.00-14 (2) 295510 JM16-IT 1-14 RH ROD END F2 FIT (2) 297102 GREASELESS PRESS IN BUSHING 2.135 X 14.3 X 58.85MM
HARDWARE INCLUDED	
(4) 605146 3/8-16 X 1.5 12 PT FLANGED CAP SCREW	
TOOLS REQUIRED	
JACK JACK STANDS TORQUE WRENCH DIE GRINDER	PAINT PEN (BLACK) 19MM SOCKET / WRENCH 3/8 12-PT SOCKET / WRENCH
TECH NOTES	
<p>1. IF EQUIPPED WITH AIR RIDE SUSPENSION, KIT PN-55153 IS REQUIRED.</p> <p>2. DO NOT EXCEED 3.375" ADJUSTMENT FROM THE CENTER OF THE ROD END TO THE EDGE OF THE BILLET LINK. FAILURE CAUSED BY EXCESSIVE ADJUSTMENT WILL NOT BE COVERED UNDER ICON'S WARRANTY POLICY.</p> <p>3. LINKS ARE PRESET TO 15.438" (FACTORY LENGTH).</p> <p>4. IF CUSTOM PINION ANGLE IS DESIRED YOU CAN ADJUST THIS WITH THE VEHICLE ON THE GROUND.</p>	

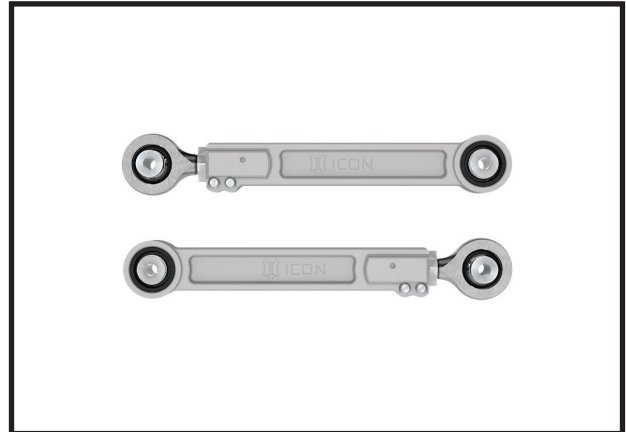

WARNING!
<p>** READ ALL INSTRUCTIONS THOROUGHLY FROM START TO FINISH BEFORE BEGINNING INSTALLATION! IF THESE INSTRUCTIONS ARE NOT PROPERLY FOLLOWED SEVERE FRAME, SUSPENSION AND TIRE DAMAGE MAY RESULT TO THE VEHICLE!</p> <p>** ICON VEHICLE DYNAMICS RECOMMENDS THAT YOU EXERCISE EXTREME CAUTION WHEN WORKING UNDER A VEHICLE THAT IS SUPPORTED WITH JACK STANDS.</p> <p>** ICON VEHICLE DYNAMICS RECOMMENDS ALL INSTALLATION TO BE PERFORMED BY A PROFESSIONAL SHOP/SERVICE TECHNICIAN. PRODUCT FAILURE CAUSED BY IMPROPER INSTALLATION WILL NOT BE COVERED UNDER ICON'S WARRANTY POLICY.</p>

INSTALLATION

- Lift vehicle and securely place heavy duty jack stands under the manufacturer recommended lifting locations for the back of the vehicle. NEVER WORK UNDER AN UNSUPPORTED VEHICLE. Remove the wheels.
- If the vehicle is equipped with air-ride suspension, refer to PN-55153 instructions for disconnecting the position sensing arm from the link.
- Remove the driver side rear upper link using a 19mm. [FIGURE 1 & 2]

FIG.1

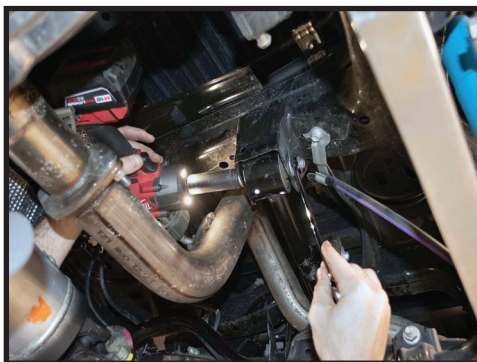
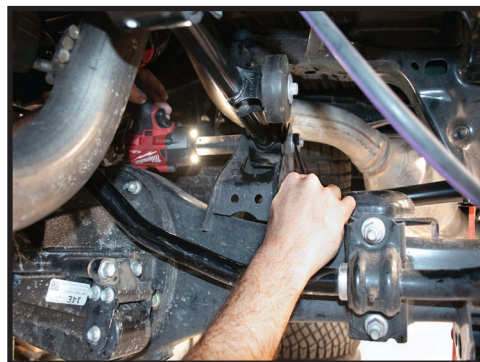

FIG.2



4. The pocket on the differential requires trimming for the billet link. Using a die grinder, grind the radius on the pocket gusset as shown. [FIGURE 3 & 4]

FIG.3

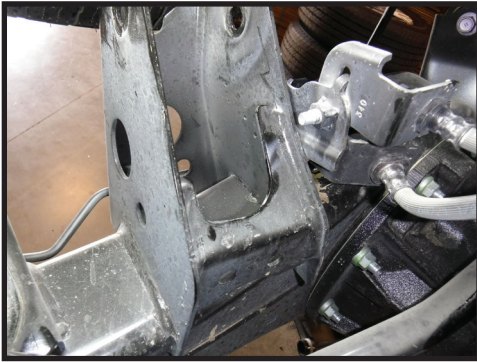
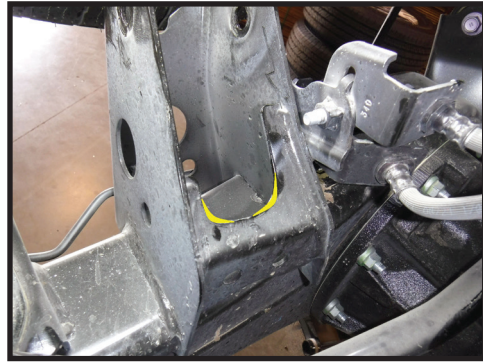

FIG.4



5. Paint exposed metal using a paint pen.

6. Install the billet link with the heim joint toward the frame and the pinch bolts down. The pinch bolts should be on the outer side of the link. Tighten the factory hardware to factory spec using a 19mm. [FIGURE 5]

FIG.5



7. Repeat steps on opposite side of vehicle.

8. To adjust, loosen the pinch bolts billet link using a 3/8" 12pt. Turn the L/R adjusting collar until desired length is reached.

9. Make sure that the slit in the collar is lined up with the slit in the pinch housing and tighten pinch bolts using an alternating pattern [Torque to 40 ft-lbs]. Go back and forth between bolts 3 times to torque equally.

10. Never exceed the maximum length as listed in the tech notes.

[TECH NOTE #1]

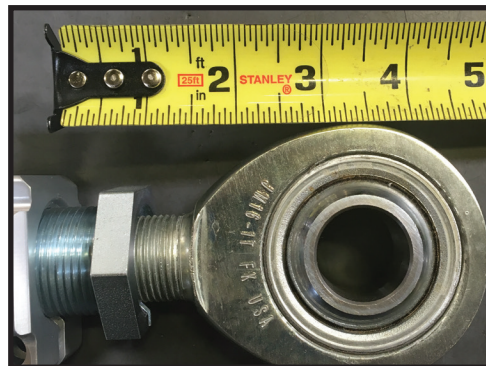

VERIFY ALL FASTENERS ARE PROPERLY TORQUED BEFORE DRIVING VEHICLE.

RETORQUE ALL NUTS, BOLTS AND LUGS AFTER 100 MILES AND PERIODICALLY THEREAFTER.

ICON VEHICLE DYNAMICS LIMITED LIFETIME WARRANTY

ICON Vehicle Dynamics warrants to the original retail purchaser who owns the vehicle on which the product was originally installed. ICON Vehicle Dynamics does not warrant the product for finish, alterations, modifications and/or installation contrary to ICON Vehicle Dynamics instructions. ICON Vehicle Dynamics products are not designed, nor are they intended to be installed on vehicles used in race applications, for racing purposes or for similar activities. (A "race" is defined as any contest between two or more vehicles, or a contest of one or more vehicles against the clock, whether or not such contest is for a prize). This warranty does not include coverage for police or taxi vehicles, race vehicles, or vehicles used for government or commercial purposes. Also excluded from this warranty are sales outside of the United States of America and Canada.

ICON Vehicle Dynamics' obligation under this warranty is limited to the repair or replacement, at ICON Vehicle Dynamics' discretion, of the defective product. Any and all costs of removal, installation or re-installation, freight charges and incidental or consequential damages are expressly excluded from this warranty. Items that are subject to wear are not considered defective when worn and are not covered.

ICON Vehicle Dynamics components must be installed as a complete kit as shown in our current application guide. Any substitutions or exemptions of required components will immediately void the warranty. Some finish damage may happen to parts during shipping and is not covered under warranty.

This warranty is expressly in lieu of all other warranties expressed or implied. This warranty shall not apply to any product that has been improperly installed, modified or customized subject to accident, negligence, abuse or misuse.



ICON VEHICLE DYNAMICS®
PERFORMANCE SUSPENSION SYSTEMS AND SHOCK ABSORBERS

7929 Lincoln Ave. Riverside, CA 92504 Phone: 951.689.ICON Fax: 951.689.1016
www.iconvehicledynamics.com



FOLLOW US ON FACEBOOK!



7929 Lincoln Ave. Riverside, CA 92504
 Phone: 951.689.ICON | Fax: 951.689.1016

PART #	DESCRIPTION
57840EP	22-UP TUNDRA 0-1" REAR 2.5 VS CDEV RR PAIR

COMPONENTS INCLUDED	
(1) 154874RED 22-UP TUNDRA 2.5 0-1" REAR VS CDEV RR DRVR UNPKG	(1) 154874REP 22-UP TUNDRA 2.5 0-1" REAR VS CDEV PASS UNPKG
HARDWARE INCLUDED	
(2) 250003 10.00 UNIVERSAL RESI MT PLATE CZINC (2) 605144 3/8-12 X .750 FLANGED SELF TAP BOLT CZINC (1) 255604-16 EXTENSION HARNESS COIL 16-FT (2) 605929 11 X 0.178 NYLON CABLE TIE, BLACK	(2) 611008 9/16 RXT HEAVY DUTY STEM BUSHING KIT (2) 611051 #36 1.188-2.750 STAINLESS HOSE CLAMP KIT (4) (1) 255604-20 EXTENSION HARNESS COIL 20-FT (2) 605131 3/8 SPLIT LOCK WASHER GR8 YZINC
TOOLS REQUIRED	
JACK JACK STANDS TORQUE WRENCH RATCHETS EXTENSION DRILL 11/32 DRILL BIT	SHARPIE 8MM 17MM 19MM 9/16" 5/16" NUT DRIVER OR FLAT BLADE SCREW DRIVER
TECH NOTES	
<p>1. YOUR ICON SHOCK ASSEMBLIES COME FACTORY CHARGED TO 250 PSI. RELEASING NITROGEN PRESSURE MAY LEAD TO SHOCK MALFUNCTION AND REDUCED RIDE QUALITY. FAILURE CAUSED BY LOW NITROGEN PRESSURE IS NOT COVERED UNDER ICON'S WARRANTY POLICY.</p> <p>2. BE CAUTIOUS WHEN LOWERING THE AXLE WITHOUT THE SHOCKS ATTACHED, THE BRAKE LINES CAN BECOME STRETCHED AND CAUSE DAMAGE.</p> <p>3. ESTIMATED INSTALL TIME: 1.5 HOURS</p>	



WARNING!

**** READ ALL INSTRUCTIONS THOROUGHLY FROM START TO FINISH BEFORE BEGINNING INSTALLATION! IF THESE INSTRUCTIONS ARE NOT PROPERLY FOLLOWED SEVERE FRAME, SUSPENSION AND TIRE DAMAGE MAY RESULT TO THE VEHICLE!**

**** ICON VEHICLE DYNAMICS RECOMMENDS THAT YOU EXERCISE EXTREME CAUTION WHEN WORKING UNDER A VEHICLE THAT IS SUPPORTED WITH JACK STANDS.**

**** ICON VEHICLE DYNAMICS RECOMMENDS ALL INSTALLATION TO BE PERFORMED BY A PROFESSIONAL SHOP/SERVICE TECHNICIAN. PRODUCT FAILURE CAUSED BY IMPROPER INSTALLATION WILL NOT BE COVERED UNDER ICON'S WARRANTY POLICY.**

INSTALLATION

1. Lift vehicle and securely place heavy duty jack stands under the manufacturer recommended lifting locations for the rear of the vehicle. Take care when lifting the vehicle and allow 3-4" of ground clearance from the tire. Remove front tires. NEVER WORK UNDER AN UNSUPPORTED VEHICLE. Remove the wheels.
2. Support the rear axle and remove the rear shocks.
3. Remove the upper nut using an 8mm to hold the stud and 19mm to remove the nut. [FIGURE 1]



FIG.1

4. Remove the lower bolt using a 17mm. [FIGURE 2]



FIG.2

5. Install optional shock boot securing the top of the boot with the supplied zip-tie.

6. Install the new Icon stem bushings onto the Icon shock. Place the washer with the bigger hole on, then a bushing. Place the stem into the upper shock mount, then another bushing and the washer, thread on one of the supplied nuts, tighten it down until the second nut can on and 3-4 thread show with both nuts installed. [FIGURE 3]

FIG.3



7. Install the lower eyelet of the Icon shock onto the axle stud. Use the supplied sleeves to position the eyelet correctly. Sleeve, shock eyelet, sleeve. Use the factory bolt and torque to factory specs. [FIGURE 4 & 5]

FIG.4



FIG.5



8. For reservoir mounting, use the supplied reservoir bracket and hold the reservoir and bracket up to the frame as shown, and mark the hole to drill it to 11/32" (SHOCK APPEARANCE MAY CHANGE DUE TO ONGOING DEVELOPMENT). [FIGURE 6, 7, 8]

FIG.6



FIG.7



FIG.8



9. With the hole drilled, take the supplied 3/8" self-tap flanged bolt and reservoir bracket and install onto the frame.

10. Using the supplied hose clamps, clamp the reservoir onto the bracket as shown (If desired, the supplied heat shrink material can be cut to fit over the hose clamps). [FIGURE 9 & 10]

FIG.9

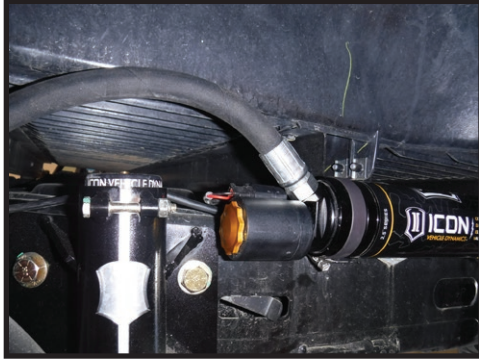

FIG.10



11. With the shocks installed. Reinstall the wheels and tires, lower to the ground and torque the lug nuts to factory spec.

VERIFY ALL FASTENERS ARE PROPERLY TORQUED BEFORE DRIVING VEHICLE.

RETORQUE ALL NUTS, BOLTS AND LUGS AFTER 100 MILES AND PERIODICALLY THEREAFTER.

2.5 VS SERIES SHOCK & COILOVER TECHNICAL INFORMATION

MAINTENANCE

ICON shock absorbers are a high quality rebuildable race style shock absorber designed for optimal performance. With a unit of this caliber on your vehicle, routine maintenance is required to keep them looking and operating in like new condition. Residual oil and assembly lube may be present at all seal paths from the factory out of the box and is considered normal. Pooling of oil however is not acceptable at any time and one should contact the ICON dealer where purchased.

BELOW ARE GUIDELINES BASED ON HOW YOU USE YOUR VEHICLE BUT YOUR MILEAGE MAY VARY:

STREET USE:

- Send in for factory servicing every 40,000 miles or if a leak develops, ride quality decreases, or they begin to make excessive noise.
- Remove any buildup of road salt, mud, or debris from shocks and coil springs anytime accrued
- Clean with mild soap and water with each oil change or anytime you notice build up.
- Wax the cylinders yearly with automotive wax to prevent corrosion.
- Check nitrogen pressure yearly. (252004 charge needle assembly available at any ICON distributor)
- Check bearings for excessive wear yearly.
- DO NOT apply any type of lube to the upper and lower bearings.

STREET/DIRT:

- Send in for factory servicing every 15,000 miles or if a leak develops, ride quality decreases, or they begin to make excessive noise.
- Clean with mild soap and water with each oil change, offroad trip, or anytime you notice build up.
- Wax the cylinders yearly with automotive wax to prevent corrosion.
- Check nitrogen pressure each dirt outing. (252004 charge needle assembly available at any ICON distributor)
- Check bearings for excessive wear yearly.
- DO NOT apply any type of lube to the upper and lower bearings.

DIRT USE:

- Send in for factory servicing every 1,000 miles.
- Check nitrogen pressure each outing. (252004 charge needle assembly available at any ICON distributor)
- Remove any buildup of mud or debris from shocks and coil springs after every outing.

SELF-SERVICE:

- Contact ICON for service kits & tools at (951) 689-4266.

PRODUCT REGISTRATION

Please visit: <http://www.iconvehicledynamics.com/tech-support/registration/> to register your product.

ICON VEHICLE DYNAMICS SHOCK ABSORBER WARRANTY

This shock absorber has a 1 year warranty against any manufacturer's defects. If a shock fails within the initial year of ownership, the shock must be shipped to ICON Vehicle Dynamics for inspection and service. If a shock is inspected and it has been determined the shock failed due to neglect, damage caused by improper installation or any other reason besides "normal wear and tear", the owner of said shock is responsible for all service costs. This includes labor, parts, and shipping.

ICON Vehicle Dynamics warrants to the original retail purchaser who owns the vehicle on which the product was originally installed. ICON Vehicle Dynamics does not warrant the product for finish, alterations, modifications and/or installation contrary to ICON Vehicle Dynamics instructions. ICON Vehicle Dynamics products are not designed, nor are they intended to be installed on vehicles used in race applications, for racing purposes or for similar activities. (A "race" is defined as any contest between two or more vehicles, or a contest of one or more vehicles against the clock, whether or not such contest is for a prize). This warranty does not include coverage for police or taxi vehicles, race vehicles, or vehicles used for government or commercial purposes. Also excluded from this warranty are sales outside of the United States of America and Canada.

ICON Vehicle Dynamics' obligation under this warranty is limited to the repair or replacement, at ICON Vehicle Dynamics' discretion, of the defective product. Any and all costs of removal, installation or re-installation, freight charges and incidental or consequential damages are expressly excluded from this warranty. Items that are subject to wear are not considered defective when worn and are not covered.

ICON Vehicle Dynamics components must be installed as a complete kit as shown in our current application guide. Any substitutions or exemptions of required components will immediately void the warranty. Some finish damage may happen to parts during shipping and is not covered under warranty.

This warranty is expressly in lieu of all other warranties expressed or implied. This warranty shall not apply to any product that has been improperly installed, modified or customized subject to accident, negligence, abuse or misuse.

To send a shock in for warranty please visit our website <http://www.iconvehicledynamics.com/tech-support/shock-service/>



ICON VEHICLE DYNAMICS®
PERFORMANCE SUSPENSION SYSTEMS AND SHOCK ABSORBERS

7929 Lincoln Ave. Riverside, CA 92504 Phone: 951.689.ICON Fax: 951.689.1016
www.iconvehicledynamics.com



FOLLOW US ON FACEBOOK!



7929 Lincoln Ave. Riverside, CA 92504
 Phone: 951.689.ICON | Fax: 951.689.1016

PART #	DESCRIPTION
58561DJ	22-UP TOYOTA TUNDRA BILLET UCA KIT

COMPONENTS INCLUDED	
(1) 157619 22-UP TUNDRA BILLET UCA DRVR	(1) 157620 22-UP TUNDRA BILLET UCA PASS
HARDWARE INCLUDED	
(4) 157509 HEIM SPACER JM12 X 16MM X 1.875 CZINC (4) 157510 HEIM SPACER JM12 X 16MM X 2.875 CZINC	(2) 297165 DELTA PRO BILLET UCA DUST COVER (8) 605002 6-32 X 0.500 SHCS 18-8 RAW (2) 605890 M14 FENDER WASHER 36MM OD (1) 605968 VIBRATITE BLUE 2ML BULLET
TOOLS REQUIRED	
JACK JACK STANDS #2 PHILLIPS SCREWDRIVER BODY CLIP REMOVAL TOOL SMALL FLAT BLADE SCREWDRIVER NEEDLE NOSE PLIERS TORQUE WRENCH	10MM SOCKET / WRENCH 12MM SOCKET / WRENCH 19MM SOCKET / WRENCH 22MM SOCKET / WRENCH 3/8 12-PT
TECH NOTES	
<p>1. DO NOT EXCEED 1.875" ADJUSTMENT FROM THE CENTER OF THE ROD END TO THE EDGE OF THE BILLET UPPER CONTROL ARM. FAILURE CAUSED BY EXCESSIVE ADJUSTMENT WILL NOT BE COVERED UNDER ICON'S WARRANTY POLICY. REFER TO TECH NOTE PHOTO.</p> <p>2. ICON DELTA JOINTS ARE PRE-GREASED FROM THE FACTORY. ICON RECOMMENDS GREASING THE DELTA JOINT EVERY 3,000 MILES (OR EVERY OIL CHANGE). ADD NEW GREASE UNTIL ALL OF THE OLD GREASE IS EXPELLED FROM THE BOTTOM OF THE DELTA JOINT ASSEMBLY, WIPE AWAY EXCESS WITH A RAG OR SHOP TOWEL.</p> <p>3. ALL ICON UPPER CONTROL ARMS HAVE BEEN ENGINEERED TO ALLOW FOR THE MOST POSSIBLE CASTER, WHILE STILL ALLOWING THE VEHICLE TO BE PROPERLY ALIGNED. NOTIFY YOUR PROFESSIONAL ALIGNMENT SHOP OF THIS INFORMATION SO THAT MAXIMUM RIDE QUALITY CAN BE ACHIEVED.</p> <p>4. ESTIMATED INSTALL TIME: 3 HOURS</p>	

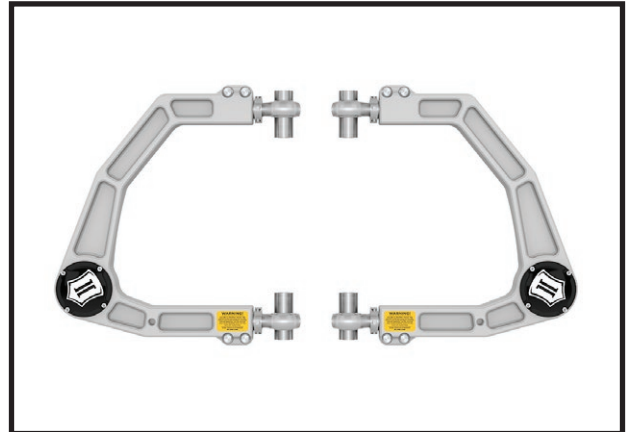

WARNING!
<p>** READ ALL INSTRUCTIONS THOROUGHLY FROM START TO FINISH BEFORE BEGINNING INSTALLATION! IF THESE INSTRUCTIONS ARE NOT PROPERLY FOLLOWED SEVERE FRAME, SUSPENSION AND TIRE DAMAGE MAY RESULT TO THE VEHICLE!</p> <p>** ICON VEHICLE DYNAMICS RECOMMENDS THAT YOU EXERCISE EXTREME CAUTION WHEN WORKING UNDER A VEHICLE THAT IS SUPPORTED WITH JACK STANDS.</p> <p>** ICON VEHICLE DYNAMICS RECOMMENDS ALL INSTALLATION TO BE PERFORMED BY A PROFESSIONAL SHOP/SERVICE TECHNICIAN. PRODUCT FAILURE CAUSED BY IMPROPER INSTALLATION WILL NOT BE COVERED UNDER ICON'S WARRANTY POLICY.</p>

INSTALLATION

- Lift vehicle and securely place heavy duty jack stands under the manufacturer recommended lifting locations for the front of the vehicle. Take care when lifting the vehicle, and allow 3-4" of ground clearance from the tire. Remove front tires. NEVER WORK UNDER AN UNSUPPORTED VEHICLE. Remove the wheels.
- Open the hood and disconnect the negative terminal on the battery using a 12mm and unplug the electrical connector.
- Unplug the electrical connector on the air intake tube. [FIGURE 1]



FIG.1

- Remove the airbox. Loosen the hose clamp with a #2 phillips screwdriver or 10mm on the air intake hose located closest to the engine. [FIGURE 2]

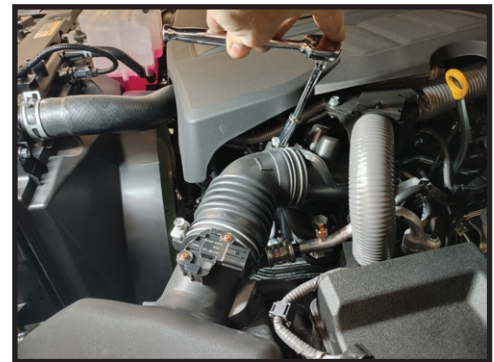

FIG.2

5. Lift up on box and remove. The box is only held in place by the intake tube and rubber grommets underneath.

6. With the box removed, remove the wiring clips from the ECU bracket. [FIGURE 3 & 4]

FIG.3

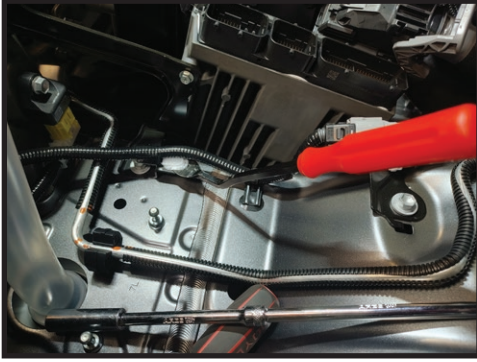

FIG.4



7. Unplug the small grey connector next to the ECU.

8. Unplug the ECU harnesses from the ECU. Push down on the safety latch and push the lever the opposite way. The connector will lift up and you will be able to remove it completely. [FIGURE 5 & 6]

FIG.5

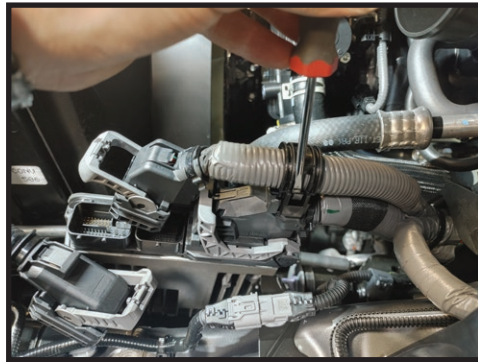

FIG.6



9. Remove the harness clamp from the large wire loom using a small flat blade screwdriver. [FIGURE 7]

FIG.7



10. Remove the large harness from the ECU. Press lock clip and pull up on the grey lever and pulling plug out. [FIGURE 8]

FIG.8



11. Remove 3 10mm bolts from the ECU bracket. One on the front core support, two on the fender well. [FIGURE 9 & 10]

FIG.9

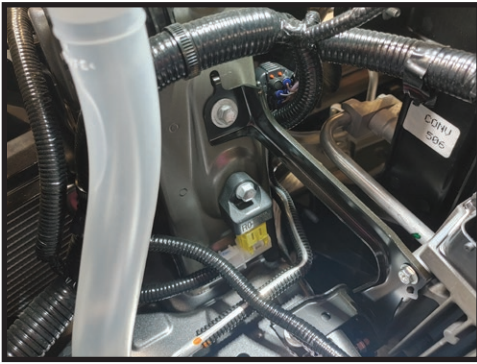
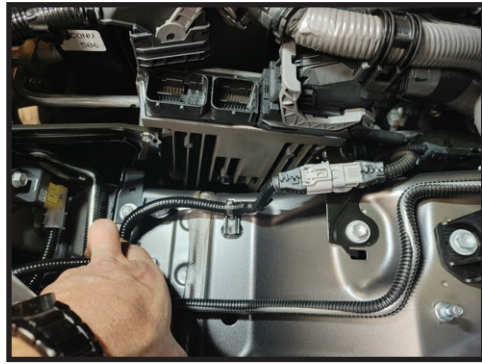

FIG.10



12. Remove the splash guards from the fender well using a needle nose pliers to pinch the clip and pull out. [FIGURE 11]

FIG.11



13. Remove the 12mm bolt from the top of the UCA that holds the ABS wire. [FIGURE 12]

FIG.12



14. Remove the cotter pin from the UCA balljoint using a small screwdriver or pick to pry over the safety clip and pull out the pin using a needle nose pliers. Loosen the 19mm nut on the balljoint. [FIGURE 13 & 14]

FIG.13



FIG.14



15. Use a hammer or balljoint separator to loosen the balljoint taper from the spindle. [FIGURE 15]

FIG.15



16. Loosen and remove the UCA pivot bolt from the frame using a 22mm. [FIGURE 16]

FIG.16



17. Remove the factory UCA. [FIGURE 17]

FIG.17



18. Prepare Icon Billet UCA for install. Be sure the heim spacers are correctly installed. Refer to photo. [FIGURE 18]

FIG.18



19. Install the ICON UCA into position and slide the factory mounting bolt through the heims, spacers and frame. [FIGURE 19 & 20]

FIG.19

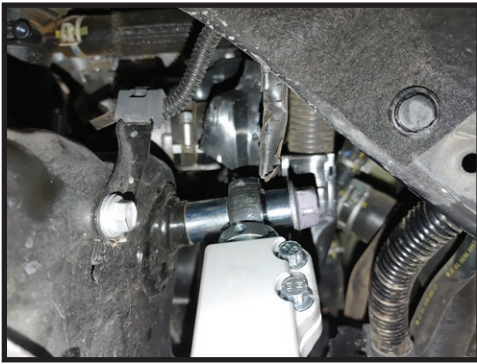

FIG.20



20. Install the Delta Joint Pro into the spindle, apply included blue thread locker to threads on flange nut and thread on to Delta Joint Pro with washer (605890) between the flange nut and spindle [Torque the nut to 70 ft-lbs]. [FIGURE 21]

FIG.21



21. Install the ABS bracket onto the Billet UCA using the factory bolt. [FIGURE 22]

FIG.22



22. Torque the factory long pivot bolt to OEM spec.

23. Install the supplied delta joint dust cap and o-ring using the four 6-32 x .500 stainless screws with a small amount of blue thread locker to the threads. [FIGURE 23]

FIG.23



- 24.** Reinstall the ECU and airbox in reverse order of removal.
- 25.** Repeat steps 12-21 on passenger side.
- 26.** Reinstall wheels and tires and carefully lower vehicle to the ground. Torque lug nuts to factory spec.

[TECH NOTE #1]



VERIFY ALL FASTENERS ARE PROPERLY TORQUED BEFORE DRIVING VEHICLE.

RETORQUE ALL NUTS, BOLTS AND LUGS AFTER 100 MILES AND PERIODICALLY THEREAFTER.

ICON VEHICLE DYNAMICS LIMITED LIFETIME WARRANTY

ICON Vehicle Dynamics warrants to the original retail purchaser who owns the vehicle on which the product was originally installed. ICON Vehicle Dynamics does not warrant the product for finish, alterations, modifications and/or installation contrary to ICON Vehicle Dynamics instructions. ICON Vehicle Dynamics products are not designed, nor are they intended to be installed on vehicles used in race applications, for racing purposes or for similar activities. (A "race" is defined as any contest between two or more vehicles, or a contest of one or more vehicles against the clock, whether or not such contest is for a prize). This warranty does not include coverage for police or taxi vehicles, race vehicles, or vehicles used for government or commercial purposes. Also excluded from this warranty are sales outside of the United States of America and Canada.

ICON Vehicle Dynamics' obligation under this warranty is limited to the repair or replacement, at ICON Vehicle Dynamics' discretion, of the defective product. Any and all costs of removal, installation or re-installation, freight charges and incidental or consequential damages are expressly excluded from this warranty. Items that are subject to wear are not considered defective when worn and are not covered.

ICON Vehicle Dynamics components must be installed as a complete kit as shown in our current application guide. Any substitutions or exemptions of required components will immediately void the warranty. Some finish damage may happen to parts during shipping and is not covered under warranty.

This warranty is expressly in lieu of all other warranties expressed or implied. This warranty shall not apply to any product that has been improperly installed, modified or customized subject to accident, negligence, abuse or misuse.



ICON VEHICLE DYNAMICS®
PERFORMANCE SUSPENSION SYSTEMS AND SHOCK ABSORBERS

7929 Lincoln Ave. Riverside, CA 92504 Phone: 951.689.ICON Fax: 951.689.1016
www.iconvehicledynamics.com



FOLLOW US ON FACEBOOK!



7929 Lincoln Ave. Riverside, CA 92504
Phone: 951.689.ICON | Fax: 951.689.1016

PART #	DESCRIPTION
58775E	22-UP TUNDRA 3.0 VS RR CDEV COILOVER KIT

COMPONENTS INCLUDED	
(1) 154974RED 22-UP TUNDRA 3.0 VS RR CDEV CO DRV R UNPKG	(1) 154974REP 22-UP TUNDRA 3.0 VS RR CDEV CO PASS UNPKG
HARDWARE INCLUDED	
(2) 150122 1.50 X .438 X .313 ALUMINUM WASHER (1) 150126 22-UP TUNDRA FRONT RESI MOUNT DRV R (1) 150127 22-UP TUNDRA FRONT RESI MOUNT PASS (1) 255604-04 EXTENSION HARNESS COIL 4-FT	(4) 605144 3/8-12 X .750 FLANGED SELF TAP BOLT CZINC (4) 605131 3/8 SPLIT LOCK WASHER GR8 YZINC (1) 611025 07-22 TUNDRA CO HARDWARE KIT (1) 611051 #36 1.188-2.750 STAINLESS HOSE CLAMP KIT (4) (1) 255604-08 EXTENSION HARNESS COIL 8-FT
TOOLS REQUIRED	
JACK JACK STANDS HAMMER BALLJOINT SEPERATOR FLAT BLADE SCREWDRIVER NEEDLE NOSE PLIERS TORQUE WRENCH RATCHET 10MM SOCKET / WRENCH	12MM SOCKET / WRENCH 14MM SOCKET / WRENCH 19MM SOCKET / WRENCH 22MM SOCKET / WRENCH 24MM SOCKET / WRENCH 38MM SOCKET / WRENCH 12 POINT AXLE SOCKET 5/16" NUT DRIVER 9/16"
TECH NOTES	
<p>1. YOUR ICON COILOVER ASSEMBLIES COME FACTORY CHARGED TO 150 PSI. RELEASING NITROGEN PRESSURE MAY LEAD TO SHOCK MALFUNCTION AND REDUCED RIDE QUALITY. FAILURE CAUSED BY LOW NITROGEN PRESSURE IS NOT COVERED UNDER ICON'S WARRANTY POLICY.</p> <p>2. YOUR ICON COILOVER ASSEMBLIES COME SHIPPED AT ICON'S RECOMMENDED RIDE HEIGHT. REDUCING DROOP TRAVEL WILL REDUCE RIDE QUALITY. DO NOT PRELOAD THE COIL BEYOND 1.75" OF EXPOSED THREADS BETWEEN THE BOTTOM OF THE TOP CAP AND THE TOP OF THE COIL ADJUSTER NUT. ADJUSTING PRELOAD BEYOND THIS SETTING WILL CAUSE THE COIL TO BIND AND DAMAGE WILL OCCUR TO COILOVER AND/OR VEHICLE.</p> <p>3. ICON DOES NOT RECOMMEND LIFTING APPROXIMATELY 2.25" OF LIFT WITHOUT AN ICON UPPER CONTROL ARM (PN: 58461DJ OR 58561DJ). FAILURE TO DO SO CAN CAUSE DAMAGE TO AXLES.</p> <p>4. FOR NON TRD MODELS, ICON RECOMMENDS USING ICON DIFF DROP (PN: 55156) OR USING TOYOTA TRD AXLES (PN: 434200C020-DRIVER, PN: 434100C020-PASSENGER). FAILURE TO DO SO COULD RESULT IN AXLE DAMAGE.</p> <p>5. INSTALL TIME: 3-4 HOURS.</p>	



WARNING!
<p>** READ ALL INSTRUCTIONS THOROUGHLY FROM START TO FINISH BEFORE BEGINNING INSTALLATION! IF THESE INSTRUCTIONS ARE NOT PROPERLY FOLLOWED SEVERE FRAME, SUSPENSION AND TIRE DAMAGE MAY RESULT TO THE VEHICLE!</p> <p>** ICON VEHICLE DYNAMICS RECOMMENDS THAT YOU EXERCISE EXTREME CAUTION WHEN WORKING UNDER A VEHICLE THAT IS SUPPORTED WITH JACK STANDS.</p> <p>** ICON VEHICLE DYNAMICS RECOMMENDS ALL INSTALLATION TO BE PERFORMED BY A PROFESSIONAL SHOP/SERVICE TECHNICIAN. PRODUCT FAILURE CAUSED BY IMPROPER INSTALLATION WILL NOT BE COVERED UNDER ICON'S WARRANTY POLICY.</p>

2. Disconnect the sway bar link from the lower arm using a 19mm. Use a dead blow hammer to remove the link from the stud on the lower arm. Reinsert the bolt into the arm to keep track of it. [FIGURE 1]

INSTALLATION

1. Lift vehicle and securely place heavy duty jack stands under the manufacturer recommended lifting locations for the front of the vehicle. Take care when lifting the vehicle, and allow 3-4" of ground clearance from the tire. Remove front tires. NEVER WORK UNDER AN UNSUPPORTED VEHICLE. Remove the wheels.

FIG.1



3. Loosen and remove the nut of the upper portion of the link using a 19mm. Remove the link from the swaybar and set aside with the nut.

4. Remove the (2) 12mm bolts that hold the brake line and abs bracket to the spindle. [FIGURE 2]

FIG.2



5. Remove the brake caliper from the spindle using a 19mm. Once removed, use a strap or rope to support the caliper so it does not hang by the brake line. Remove the brake rotor and set aside. [FIGURE 3 & 4]

FIG.3

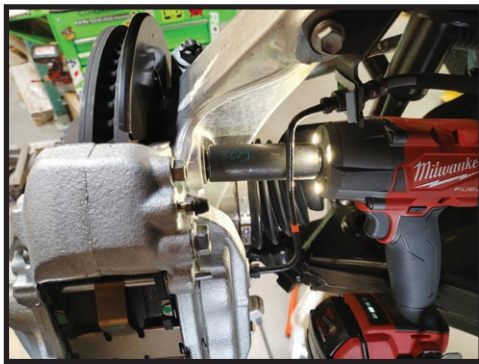
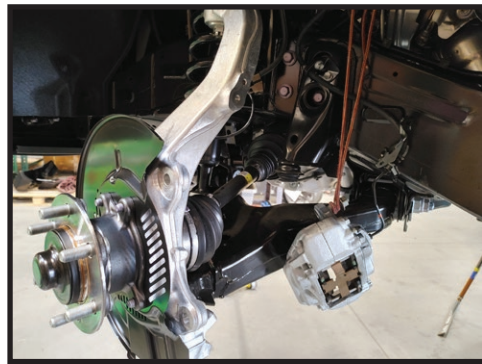
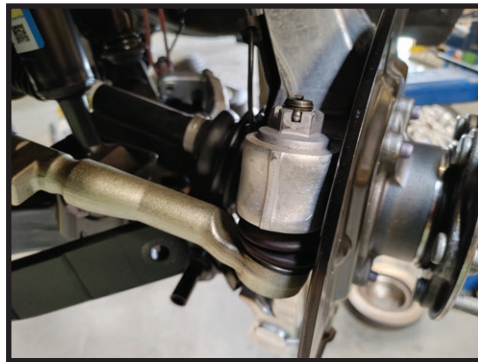

FIG.4



6. Use a pliers to remove the cotter pin from the tie rod nut/stud. Remove the tie rod nut using a 24mm. [FIGURE 5]

FIG.5



7. Use a ball joint separator or a hammer to loosen the tie rod stud taper from the spindle. [FIGURE 6]

FIG.6



8. Remove the wheel speed sensor from the front side of the spindle using a 10mm. Remove the bracket from the spindle using a 12mm. [FIGURE 7 & 8]

FIG.7



FIG.8



9. Remove the hub cap from the hub using a flat blade screwdriver to pry it away and off. [FIGURE 9 & 10]

FIG.9

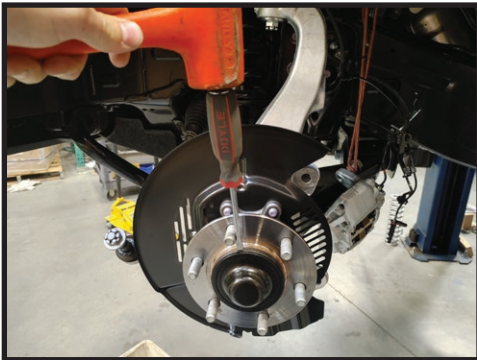
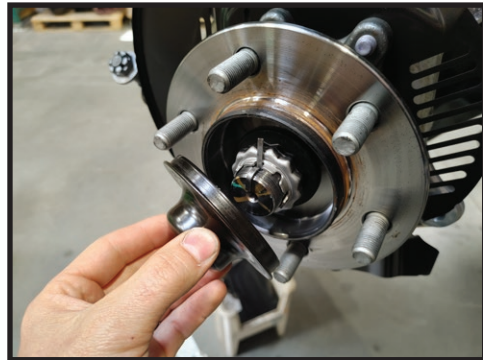

FIG.10



10. Use a pliers to remove the cotter pin holding the nut lock plate in place. [FIGURE 11]

FIG.11



11. Use a 38mm 12 point socket on an impact wrench to remove the axle nut. [FIGURE 12]

FIG.12



12. Use a deadblow hammer to hit the stub axle free of the hub. It won't come completely out of the hub yet.

13. Remove the cotter pin from the upper control arm stud/nut.

14. Use a 19mm to loosen the upper control arm ball joint nut. [FIGURE 13]

FIG.13



15. Use a balljoint separator or a hammer to loosen the balljoint taper from the spindle. Once loose, remove the nut and support the spindle so it does not fall free. [FIGURE 14]

FIG.14



16. Use a 22mm to remove the 2 bolts from the bottom side of the spindle. Remove spindle being sure the stub axle comes out of the spindle. [FIGURE 15 & 16]

FIG.15

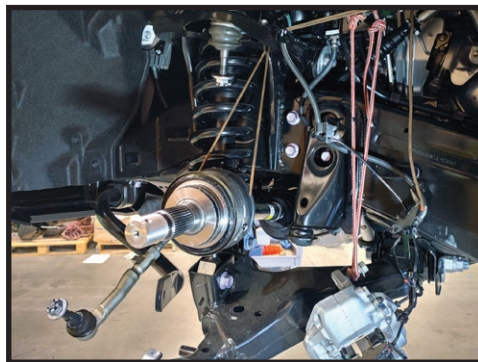

FIG.16



17. Use a rope or strap to support the cv/axle assembly out of the way. [FIGURE 17]

FIG.17



18. Support lower control arm and loosen the pivot bolts at the frame using a 24mm.

19. Remove the lower shock bolt using a 22mm. [FIGURE 18]

FIG.18



20. Remove upper shock mount nuts using a 14mm. [FIGURE 19]

FIG.19



21. Lower the control arm and remove the coilover assembly. [FIGURE 20]

FIG.20

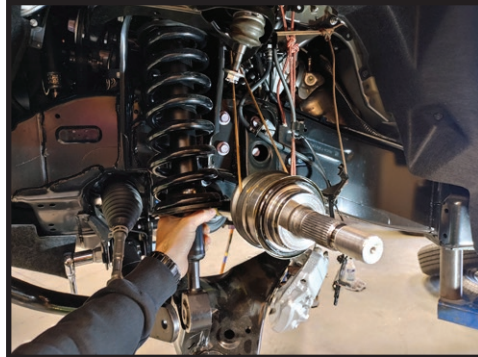

22. Grind/cut the lower shock pocket on the control arm to add clearance for the new ICON coilover assembly. Removing the control arm can help make this easier. If removed, be sure the bolts go back into the same place and orientation. After cutting is complete, paint over the raw metal to prevent rust. [FIGURE 21 & 22]

FIG.21



FIG.22



23. Reinstall the control arm now, if removed.

24. Install the new ICON coilover, lower mount first, then the upper. Torque the upper bolts to 35 ft-lbs using a 9/16" and the lower bolt to factory spec using a 22mm socket and wrench. [FIGURE 23 & 24]

FIG.23

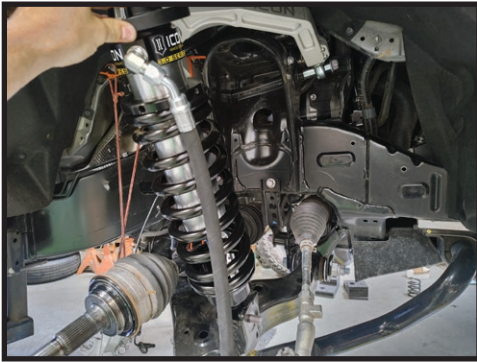

FIG.24



25. Remove the front rubber splash guard using a needle nose pliers to pinch and pull the clips out. 3 on driver side and 4 on passenger side. [FIGURE 25]

FIG.25



26. With the splash guard removed, drill out the two holes on the frame to 5/16". Locate the reservoir bracket in the box along with 2 self threading 3/8 x 1" screws. Attach the bracket using the screws into the 2 frame holes that the splash guard used. The brackets have a slight bend in them that faces out to clear the fender well. Use the supplied hose clamps to secure the reservoir to the bracket. [FIGURE 26 & 27]

FIG.26



FIG.27



27. If an ICON UCA was purchased, install that now.

28. Reinstall spindle, insert the stub axle back into the hub, making sure the splines are aligned. Insert the lower 2 bolts into the spindle.

29. Install the upper control arm balljoint into the spindle and secure with the nut.

30. Torque the lower balljoint bolts to factory spec. Torque the upper balljoint to factory spec if using the OEM arm, or 70 ft-lbs for ICON Delta Joint Pro.

31. Install the axle nut and torque to factory spec. Install nut lock plate and cotter pin. Then use a dead blow hammer to install the hub cap.

32. Install rotor onto hub and install brake caliper back onto spindle. [Torque bolts to factory spec].

33. Reconnect brake line and ABS brackets onto spindle.

34. Install ABS sensor back into the spindle and the bracket.

35. Remove the sway bar mounting bracket from the frame and install the new drop spacers between the bracket and frame. Reinstall with the new bolts and torque to factory spec. [FIGURE 28 & 29]

FIG.28



FIG.29



36. Install tie rod and nut, torque to factory spec and reinstall cotter pin.

37. Remove factory bump stop from the frame using a large adjustable wrench or pliers. Apply thread locker to the threads of the bump stop, install the 5/16" aluminum washer onto the stud and thread the bump stop back into the frame and tighten. [FIGURE 30]

FIG.30



38. Install wheels and tires, lower vehicle to the ground. Torque lug nuts.

39. Get vehicle professionally aligned.



**VERIFY ALL FASTENERS ARE PROPERLY TORQUED BEFORE DRIVING VEHICLE.
RETORQUE ALL NUTS, BOLTS AND LUGS AFTER 100 MILES AND PERIODICALLY THEREAFTER.**

3.0 VS SERIES SHOCK & COILOVER TECHNICAL INFORMATION

MAINTENANCE

ICON shock absorbers are a high quality rebuildable race style shock absorber designed for optimal performance. With a unit of this caliber on your vehicle, routine maintenance is required to keep them looking and operating in like new condition. Residual oil and assembly lube may be present at all seal paths from the factory out of the box and is considered normal. Pooling of oil however is not acceptable at any time and one should contact the ICON dealer where purchased.

BELOW ARE GUIDELINES BASED ON HOW YOU USE YOUR VEHICLE BUT YOUR MILEAGE MAY VARY:

STREET USE:

- Send in for factory servicing every 40,000 miles or if a leak develops, ride quality decreases, or they begin to make excessive noise.
- Remove any buildup of road salt, mud, or debris from shocks and coil springs anytime accrued
- Clean with mild soap and water with each oil change or anytime you notice build up.
- Wax the cylinders yearly with automotive wax to prevent corrosion.
- Check nitrogen pressure yearly. (252004 charge needle assembly available at any ICON distributor)
- Check bearings for excessive wear yearly.
- DO NOT apply any type of lube to the upper and lower bearings.

STREET/DIRT:

- Send in for factory servicing every 15,000 miles or if a leak develops, ride quality decreases, or they begin to make excessive noise.
- Clean with mild soap and water with each oil change, offroad trip, or anytime you notice build up.
- Wax the cylinders yearly with automotive wax to prevent corrosion.
- Check nitrogen pressure each dirt outing. (252004 charge needle assembly available at any ICON distributor)
- Check bearings for excessive wear yearly.
- DO NOT apply any type of lube to the upper and lower bearings.

DIRT USE:

- Send in for factory servicing every 1,000 miles.
- Check nitrogen pressure each outing. (252004 charge needle assembly available at any ICON distributor)
- Remove any buildup of mud or debris from shocks and coil springs after every outing.

SELF-SERVICE:

- Contact ICON for service kits & tools at (951) 689-4266.

PRODUCT REGISTRATION

Please visit: <http://www.iconvehicledynamics.com/tech-support/registration/> to register your product.

ICON VEHICLE DYNAMICS SHOCK ABSORBER WARRANTY

This shock absorber has a 1 year warranty against any manufacturer's defects. If a shock fails within the initial year of ownership, the shock must be shipped to ICON Vehicle Dynamics for inspection and service. If a shock is inspected and it has been determined the shock failed due to neglect, damage caused by improper installation or any other reason besides "normal wear and tear", the owner of said shock is responsible for all service costs. This includes labor, parts, and shipping.

ICON Vehicle Dynamics warrants to the original retail purchaser who owns the vehicle on which the product was originally installed. ICON Vehicle Dynamics does not warrant the product for finish, alterations, modifications and/or installation contrary to ICON Vehicle Dynamics instructions. ICON Vehicle Dynamics products are not designed, nor are they intended to be installed on vehicles used in race applications, for racing purposes or for similar activities. (A "race" is defined as any contest between two or more vehicles, or a contest of one or more vehicles against the clock, whether or not such contest is for a prize). This warranty does not include coverage for police or taxi vehicles, race vehicles, or vehicles used for government or commercial purposes. Also excluded from this warranty are sales outside of the United States of America and Canada.

ICON Vehicle Dynamics' obligation under this warranty is limited to the repair or replacement, at ICON Vehicle Dynamics' discretion, of the defective product. Any and all costs of removal, installation or re-installation, freight charges and incidental or consequential damages are expressly excluded from this warranty. Items that are subject to wear are not considered defective when worn and are not covered.

ICON Vehicle Dynamics components must be installed as a complete kit as shown in our current application guide. Any substitutions or exemptions of required components will immediately void the warranty. Some finish damage may happen to parts during shipping and is not covered under warranty.

This warranty is expressly in lieu of all other warranties expressed or implied. This warranty shall not apply to any product that has been improperly installed, modified or customized subject to accident, negligence, abuse or misuse.

To send a shock in for warranty please visit our website <http://www.iconvehicledynamics.com/tech-support/shock-service/>



ICON VEHICLE DYNAMICS®

PERFORMANCE SUSPENSION SYSTEMS AND SHOCK ABSORBERS

7929 Lincoln Ave. Riverside, CA 92504 Phone: 951.689.ICON Fax: 951.689.1016
www.iconvehicledynamics.com



FOLLOW US ON FACEBOOK!

