



7929 Lincoln Ave. Riverside, CA 92504
 Phone: 951.689.ICON | Fax: 951.689.1016

PART #	DESCRIPTION
51010	22-23 TOYOTA TUNDRA 6" CROSS MEMBER KIT
51011	22-23 TOYOTA TUNDRA 6" FRONT BOX KIT
51014	22-23 TOYOTA TUNDRA 6" FRONT KNUCKLE KIT
51017	22-23 TOYOTA TUNDRA 6" FRONT SKID PLATE



COMPONENTS INCLUDED

<p>51010 INCLUDES:</p> <ul style="list-style-type: none"> (1) 154170 22 TUNDRA FRONT CROSS MEMBER (1) 154171 22 TUNDRA REAR CROSS MEMBER <p>51014 INCLUDES:</p> <ul style="list-style-type: none"> (1) 158100D STEERING KNUCKLE DRIVER (1) 158100P STEERING KNUCKLE PASSENGER (4) 157030 22 TUNDRA STEERING STOP (8) 605993 1/4-20 X 1 SHCS 18-8 <p>51017 INCLUDES:</p> <ul style="list-style-type: none"> (1) 154177 22 TUNDRA 6" DIFF SKID PLATE 	<p>51011 INCLUDES:</p> <ul style="list-style-type: none"> (1) 150133 22 TUNDRA FRONT UPPER BRAKELINE BRKT DRIV (1) 150134 22 TUNDRA FRONT UPPER BRAKELINE BRKT PASS (1) 150135 22 TUNDRA FRONT LOWER BRAKELINE BRKT DRIV (1) 150136 22 TUNDRA FRONT LOWER BRAKELINE BRKT PASS (1) 150138 22 TUNDRA KNUCKLE ABS BRKT DRIV (1) 150139 22 TUNDRA KNUCKLE ABS BRKT PASS (1) 150141 22 TUNDRA KNUCKLE BRAKELINE BRKT DRIV (1) 150142 22 TUNDRA KNUCKLE BRAKELINE BRKT PASS (2) 154160 22 TUNDRA TIE ROD (1) 154175 22 TUNDRA 4" SWAY BAR DROP DRIV (1) 154176 22 TUNDRA 4" SWAY BAR DROP PASS (2) 154184 22 TUNDRA FRONT BUMP STOP EXTENSION (1) 154185 22 TUNDRA FRONT BUMP STOP SUPPORT DRIV (1) 154186 22 TUNDRA FRONT BUMP STOP SUPPORT PASS
--	--

HARDWARE INCLUDED

51010H HARDWARE KIT	51011H HARDWARE KIT
<ul style="list-style-type: none"> (2) 605824 M18-2.50 X 160MM HHCS GR10.9 YZINC (2) 605820 M18-2.50 X 160MM HHCS GR10.9 YZINC (4) 605833 M18-2.5 C-LOCK GRC CZINC (8) 605832 M18 FALT WASHER GR 10.9 YZINC (1) 605969 VIBRATITE RED 2ML BULLET 	<ul style="list-style-type: none"> (1) 295003-08 8" TUNDRA BREATHER HOSE (4) 605330 1/2 SAE FLAT WASHER GR9 YZINC (4) 605302 1/2-13 X 1.500 HHCS GR8 YZINC (4) 605333 1/2-13 FLANGED NYLOCK NUT GRG YZINC (16) 605016 5/16 SAE FLAT WASHER GR8 YZINC (8) 605011 5/16-18 X 0.750 HHCS GR8 YZINC (8) 605015 5/16-18 NYLOCK NUT GR5 CZINC (4) 605060 1/4-20 X .599 LO PRO BHCS BOXIDE (2) 605830 M10-1.25 SERRATED FLANGE NUT GR8.8 CZINC (2) 605808 M10-1.25 X 25MM SHCS (2) 605866 M10 FLAT WASHER SS (6) 605121 3/8-16 NYLOCK NUT GR8 CZINC (6) 605101 3/8-16 X 1.000 HHCS GR8 YZINC (12) 605133 3/8 SAE FLAT WASHER GR8 YZINC (4) 605321 1/2-13 NYLOCK NUT GR8 YZINC (4) 605301 1/2-13 X 1.250 HHCS GR8 YZINC
51017H HARDWARE KIT	
<ul style="list-style-type: none"> (5) 605301 1/2-13 X 1.250 HHCS GR8 YZINC (5) 605333 1/2-13 FLANGED NYLOCK NUT GRG YZINC (5) 605330 1/2 SAE FLAT WASHER GR8 YZINC (1) 605969 VIBRATITE RED 2ML BULLET 	

TOOLS REQUIRED

<ul style="list-style-type: none"> JACK JACK STANDS SPRING COMPRESSOR BALL JOINT SEPERATOR FLAT BLADE SCREWDRIVER PLIERS TORQUE WRENCH RATCHETS 	<ul style="list-style-type: none"> HAMMER 4.5" GRINDER WITH CUT OFF WHEEL, RECIPRICATING SAW, DIE GRINDER WITH SANDING PAD 10, 12, 13, 14, 17, 19, 21, 22, 24, 26 SOCKET/WRENCH 38MM 12 POINT AXLE NUT SOCKET 5/32 HEX KEY 1/2", 9/16", 3/4" SOCKET/WRENCH
---	--

TOOLS REQUIRED

<ol style="list-style-type: none"> 1. INSTALL TIME: 6-8 HOURS 2. LIFT HEIGHTS INDICATED ARE FOR A STOCK EQUIPPED VEHICLE. INCREASING EIGHT OF VEHICLE DUE TO ACCESSORIES WLL ALTER LIFT RANGE. 3. NOT COMPATIBLE WITH TUNDRAS EQUIPPED WITH LOAD-LEVELING REAR HEIGHT CONTROL AIR SUSPENSION. 	<p>WARNING!</p> <p>** READ ALL INSTRUCTIONS THOROUGHLY FROM START TO FINISH BEFORE BEGINNING INSTALLATION! IF THESE INSTRUCTIONS ARE NOT PROPERLY FOLLOWED SEVERE FRAME, SUSPENSION AND TIRE DAMAGE MAY RESULT TO THE VEHICLE!</p> <p>** ICON VEHICLE DYNAMICS RECOMMENDS THAT YOU EXERCISE EXTREME CAUTION WHEN WORKING UNDER A VEHICLE THAT IS SUPPORTED WITH JACK STANDS.</p> <p>** ICON VEHICLE DYNAMICS RECOMMENDS ALL INSTALLATION TO BE PERFORMED BY A PROFESSIONAL SHOP/SERVICE TECHNICIAN. PRODUCT FAILURE CAUSED BY IMPROPER INSTALLATION WILL NOT BE COVERED UNDER ICON'S WARRANTY POLICY.</p>
--	---

INSTALLATION

1. Open and inspect all hardware and components. Compare to the lists above to be sure all hardware and components are present. Contact ICON customer service if anything is missing.
2. Place vehicle in park on a level surface. Engage parking brake. Lift front of vehicle and place jack stands under the frame, near the front body mounts. Remove the front tires. NEVER WORK UNDER AN UNSUPPORTED VEHICLE.
3. Disconnect the sway bar link from the lower arm using a 19mm. Use a dead blow hammer to remove the link from the stud on the lower arm. Reinsert the bolt into the arm to keep track of it. [FIGURE 1]

FIG.1



4. Loosen and remove the sway bar from the frame using a 17mm. The skid plate/splash shield may need to be removed to access the sway bar brackets.
5. Remove the 2 12mm bolts that hold the brake line and speed sensor bracket to the spindle. [FIGURE 2]

FIG.2



6. Remove the brake caliper from the spindle using a 19mm. Once removed, use a strap or rope to support the caliper so it does not hang by the brake line. Remove the brake rotor and set aside. [FIGURE 3 & 4]

FIG.3

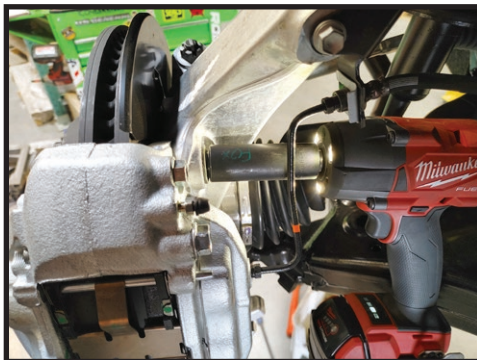
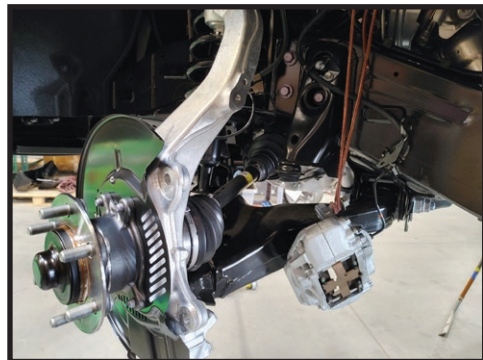

FIG.4



7. Loosen the jam nut on the tie rods.

8. Use a pliers to remove the cotter pin from the tie rod nut/stud. Remove the tie rod nut using a 24mm. [FIGURE 5]

FIG.5

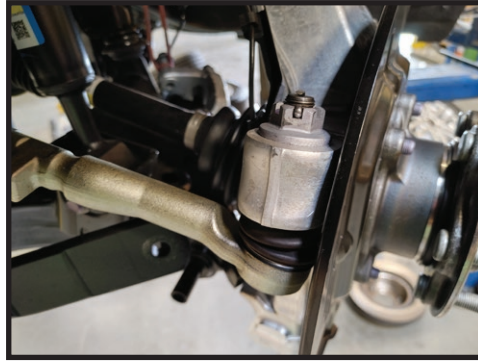

9. Use a ball joint separator or a hammer to loosen the tie rod stud taper from the spindle. Remove the outer tie rod from the inner tie rod. [FIGURE 6]

FIG.6



10. Remove the wheel speed sensor from the front side of the spindle using a 10mm. Remove the bracket from the spindle using a 12mm. [FIGURE 7 & 8]

FIG.7



FIG.8



11. Remove the hub cap from the hub using a flat blade screwdriver to pry it away and off. [FIGURE 9 & 10]

FIG.9

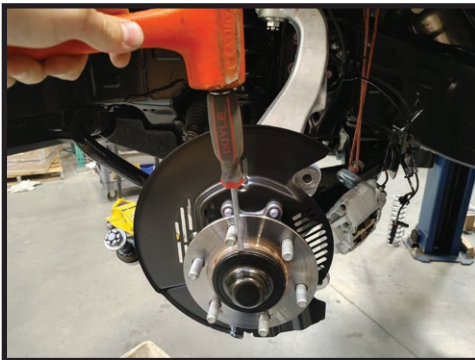
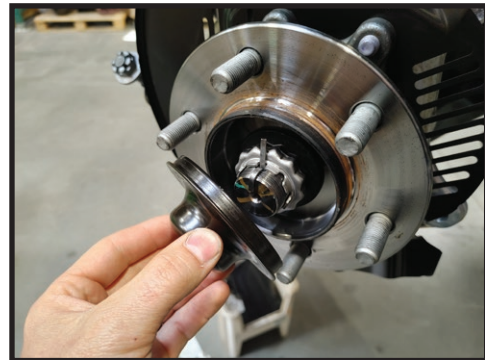
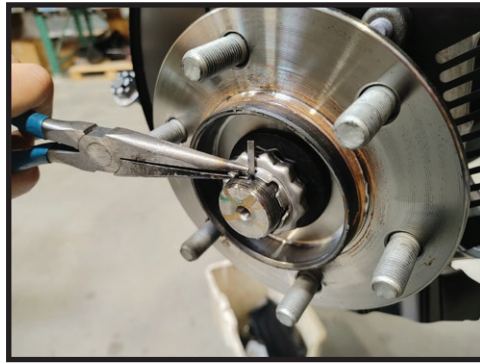

FIG.10



12. Use a pliers to remove the cotter pin holding the nut lock plate in place. [FIGURE 11]

FIG.11



13. Use a 38mm 12 point socket on an impact wrench to remove the axle nut. [FIGURE 12]

FIG.12



14. Use a deadblow hammer to hit the stub axle free of the hub. It won't come completely out of the hub yet.

15. Remove the cotter pin from the upper control arm stud/nut.

16. Use a 19mm to loosen the upper control arm ball joint nut. [FIGURE 13]

FIG.13



17. Use a 22mm to remove the 2 bolts from the bottom side of the spindle. Remove spindle being sure the stub axle comes out of the spindle. [FIGURE 14 & 15]

FIG.14

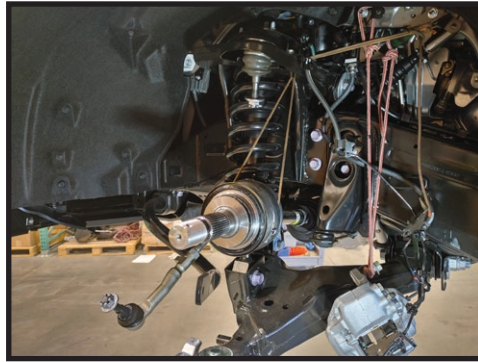

FIG.15



18. Use a rope or strap to support the cv/axle assembly out of the way. [FIGURE 16]

FIG.16



19. Remove the lower ball joint cotter pin and nut using a 24mm. Use a ball joint spreader to dislodge the taper from the knuckle adapter. Set aside, it will not be reused.

20. Support lower control arm and loosen the pivot bolts at the frame using a 24mm.

21. Remove the lower shock bolt using a 22mm. [FIGURE 17]

FIG.17

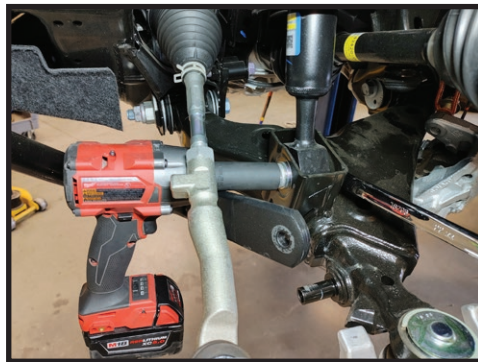

22. Remove upper shock mount nuts using a 14mm. [FIGURE 18]

FIG.18



23. Lower the control arm and remove the coilover assembly. [FIGURE 19]

FIG.19



24. Remove the bumpstop from the frame using a large adjustable wrench. [FIGURE 20]

FIG.20



25. Remove the lower control arm from the frame using a 24mm to loosen and remove the pivot/alignment bolts. Set aside the bolts as they will be reused.

26. Repeat all steps on passenger side.

27. Next will be to remove the front differential.

28. Remove the driveshaft from the back of the front differential using a 14mm. A pry bar or large screwdriver can be wedged between the frame and U-joint to keep the driveshaft from spinning.

29. The front axles can be removed from the diff using a screw driver or pry bar between the dust cover and diff and prying the axle out. The axle is held in place with a compression snap ring. Care should be taken not to damage the seal that is under the dust cover. The axles can be left in place, be careful not to let the CVs over-extend as damage can occur.

30. Disconnect the wiring harness from above the steering rack. Follow the wires that connect to the diff. Unplug the connector and remove the retaining clip so the differential can be removed. [FIGURE 21]

FIG.21



31. Remove the vent line from the top driver side of the differential. [FIGURE 22]

FIG.22



32. Support the front diff with a jack for removal. Remove the 2 bolts from the rear diff mount and diff using a 22 mm. Use a 12mm hex key and remove the purple nut from the rear diff mount from the rear cross member. Jack up the diff up until the rear mount can be removed.

33. Use a 19mm to remove the 2 bolts from the driver side diff and diff mount. Remove the 3 bolts from the passenger side diff mount using a 22mm. [FIGURE 23 & 24]

FIG.23



FIG.24



34. Use a 19mm to remove the 2 diff mounts from the front cross member. Slowly lower and remove the front diff and axles from the vehicle. [FIGURE 25 & 26]

FIG.25



FIG.26



35. With the diff removed, the rear cross member can be cut to clear the lowered differential. Using the photos below as a guide, mark where to cut. Use a cut off wheel or reciprocating saw to cut off the marked section. Clean the edges and spray paint to prevent rust and corrosion from forming. [FIGURE 27 & 28]

FIG.27



FIG.28



36. Install the new front ICON cross member. The stainless-steel shield designates the front of the front cross member. Loosely install the hardware. M18-2.50 X 130mm will be used. Install a washer under the head of the bolt before installing into the frame. Then a washer and C-lock nut. Leave the hardware loose for now. [FIGURE 29]

FIG.29



37. Replace the factory vent line with the supplied longer hose.

38. Lift the differential back in place. Reinstall the diff mounts and bolts into their respective tabs. Use a jack to hold the diff in place while the rear cross member is installed. Be sure not to pinch the wiring harness.

39. Reconnect the wiring harness and vent line.

40. With the diff in place, install the rear ICON cross member using the supplied hardware. The differential mounting tab will point to the rear of the truck. Use the remaining M18 hardware to secure the cross member to the frame mounts. Leave the hardware loose for now. [Figure 30]

FIG.30



41. Install the rear diff mount using the factory nut and bolts. Install the front mounts and bolts now. Check the clearance between the diff and the frame that was cut. Make sure the diff housing is not rubbing against the frame. [FIGURE 31 & 32]

FIG.31



FIG.32



42. Install the lower control arms into the cross-member brackets using the factory hardware. The longer bolt goes in the rear mount. Make sure the cam washer fits between the tabs on the brackets. [FIGURE 33 & 34]

FIG.33



FIG.34



43. The remaining steps can be completed on the left and right side simultaneously.

44. With both lower arms installed, you can now tighten the M18 bolts. Use thread locker on the threads. The alignment bolts need to be tightened once the truck is back on the ground.

45. Install the new bump stop extension using the supplied M10 Bolt and washer. Use thread locker. The extensions fit on both sides.

46. Install the bump stop extension support that connects to the rear cross member. The supports are left/right specific. The hardware on the extension is 3/8-16 x 1.000, washers and nylock nuts. The hardware for the support to cross member is 1/2-13x1.250, washers and nylock nut. Tighten the hardware once all the bolts and nuts are installed. Install the bump stop into the extension using the supplied M10-1.25 serrated nut and thread locker. [FIGURE 35]

FIG.35



47. Remove the upper control arm, if an ICON UCA has been purchased. If continuing to use the OEM UCA, leave it installed.

48. Move onto the OEM knuckle now. You want to remove the hub/bearing assembly. Use a 12mm hex key to loosen and remove the 4 bolts holding the hub to the knuckle. The rotor splash shield will come off with the hub assembly. Note the orientation.

49. Grab the ICON knuckle and install the hub and rotor splash shield in the same way it was removed from the OEM knuckle. Torque the bolts to 120 ft-lbs. Apply thread locker.

50. Install the steering stops, Using the 1/4-20 X 1 stainless screws. Apply blue thread locker before installing and tightening the screws. Torque to 6 ft-lbs.

51. Reinstall the axles now, if removed. Be sure the dust seal inside the differential is not cut. When inserting the axles, push in by hand until they stop, then grab a dead blow hammer, hold the axle straight out and hit the end of the axle until you feel it seat into the differential completely.

52. If any oil leaked out of the differential during removal, refill it now, with the proper spec oil. Refer to owner's manual.

53. Install the knuckle onto the lower ball joint. Rotate the ball joint so it is pointing outwards, insert the threaded end of the axle shaft into the knuckle, then slip the knuckle onto the stud and secure it with the OEM nut. Tighten the nut to OEM spec and secure it with the cotter pin.

54. Install the coil-over now. If no coil-over was purchased, install the coil spacer onto the top of the OEM coil-over and tighten the nuts to 35 ft-lbs. Install the coil-over and spacer assembly into the truck and secure with OEM nuts and bolts. Tighten the upper nuts to 35 ft-lbs. Tighten the lower pivot to OEM spec.

55. Install the axle shaft into the hub and lift the spindle so the upper balljoint can be connected and secured with the nut and cotter pin.

56. Install the axle nut and torque to OEM spec, then install the locking nut with cotter pin. Install dust cover.

57. Install the rotor, secure it with a lug nut, then install the brake caliper, making sure the lines are not twisted. Apply thread locker to the bolts and torque to 100 ft-lbs.

58. Route the speed sensor wires and brake lines so the brackets can be secured, to the knuckle using the 1/4-20 BHCS. The speed sensor wire clips will have to be carefully removed from the factory bracket and installed into the new ICON bracket. Use a needle nose or similar pliers to squeeze the backside of the clips and push them out of the bracket. [FIGURE 36 & 37]

FIG.36



FIG.37



59. Insert the speed sensor into the knuckle, using grease to lubricate the o-ring. Reuse the OEM bolt and tighten.

60. Install the OEM splash shield/skid plate that goes under the radiator, if it was removed.

61. Install the sway bar drop brackets onto the frame. The mounts are a mirror of each other. The flat side with shield should face out. Use the OEM bolts to secure the bracket to the frame. Snug the bolts.

62. Install the sway bar onto the mounts using the 1/2-13 x 1.500 bolts, washers and flanged nylock nuts. Tighten the 1/2" bolts to 70 ft-lbs. Tighten the OEM bolts to OEM specs.

63. If the sway bar links were removed from the sway bar, reinstall them now, then hook them back up to the lower control arm stud. This might need to be done when the truck is on the ground.

64. Install the new ICON tie rod and jam nut onto the OEM inner tie rod. The tie rods are identical, no left/right. Adjust the tie rod length so the knuckle assembly is visually straight. Install the tie rod stud into the knuckle from the top side. Install the supplied nylock nut and tighten to 50 ft-lbs. Tighten the tie rod jam nut.

65. If purchased, install the skid plate now. Using 1/2-13 x 1.250" bolts and washers and flanged nylock nuts. Start with rear center mounting hole. A second set of hands will be helpful to hold the skid plate in place. Then install the remaining 4 bolts. 2 in the rear corners, and 2 in the front, that go through the front cross member. [FIGURE 38, 39, 40, 41]

FIG.38

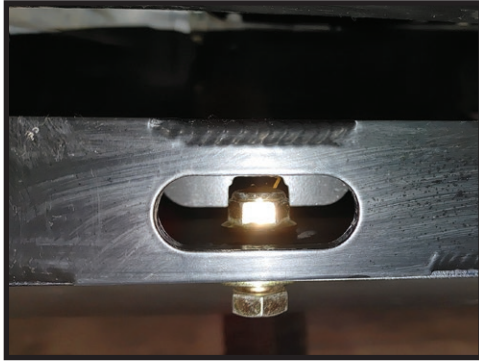

FIG.39



FIG.40



FIG.41



66. Install new wheels and tires. Set vehicle on ground and torque the lower arm pivots. Get vehicle professionally aligned.

VERIFY ALL FASTENERS ARE PROPERLY TORQUED BEFORE DRIVING VEHICLE.

RETORQUE ALL NUTS, BOLTS AND LUGS AFTER 100 MILES AND PERIODICALLY THEREAFTER.



ICON VEHICLE DYNAMICS LIMITED LIFETIME WARRANTY

ICON Vehicle Dynamics warrants to the original retail purchaser who owns the vehicle on which the product was originally installed. ICON Vehicle Dynamics does not warrant the product for finish, alterations, modifications and/or installation contrary to ICON Vehicle Dynamics instructions. ICON Vehicle Dynamics products are not designed, nor are they intended to be installed on vehicles used in race applications, for racing purposes or for similar activities. (A "race" is defined as any contest between two or more vehicles, or a contest of one or more vehicles against the clock, whether or not such contest is for a prize). This warranty does not include coverage for police or taxi vehicles, race vehicles, or vehicles used for government or commercial purposes. Also excluded from this warranty are sales outside of the United States of America and Canada.

ICON Vehicle Dynamics' obligation under this warranty is limited to the repair or replacement, at ICON Vehicle Dynamics' discretion, of the defective product. Any and all costs of removal, installation or re-installation, freight charges and incidental or consequential damages are expressly excluded from this warranty. Items that are subject to wear are not considered defective when worn and are not covered.

ICON Vehicle Dynamics components must be installed as a complete kit as shown in our current application guide. Any substitutions or exemptions of required components will immediately void the warranty. Some finish damage may happen to parts during shipping and is not covered under warranty.

This warranty is expressly in lieu of all other warranties expressed or implied. This warranty shall not apply to any product that has been improperly installed, modified or customized subject to accident, negligence, abuse or misuse.



ICON VEHICLE DYNAMICS®
PERFORMANCE SUSPENSION SYSTEMS AND SHOCK ABSORBERS

7929 Lincoln Ave. Riverside, CA 92504 Phone: 951.689.ICON Fax: 951.689.1016
www.iconvehicledynamics.com



FOLLOW US ON FACEBOOK!



PART #	DESCRIPTION
51012	22-23 TUNDRA REAR BOX KIT

COMPONENTS INCLUDED

(1) 150128 22 TUNDRA REAR UPPER BRAKELINE BRACKET (1) 150129 22 TUNDRA REAR LOWER BRAKELINE BRACKET (1) 150131 22 TUNDRA REAR UPPER LINK BRACKET DRV (1) 150132 22 TUNDRA REAR UPPER LINK BRACKET PASS	(1) 154172 REAR TRACK BAR BRACKET (1) 154173 22 TUNDRA REAR SWAY BAR LINK MNT DRV (1) 154174 22 TUNDRA REAR SWAY BAR LINK MNT PASS (2) 154189 22 TUNDRA REAR FOAM AXLE PAD 6"
---	--

HARDWARE INCLUDED

51012H HARDWARE KIT

(1) 159690 SLEEVE 1.000 X 0.561 X 1.580 CZINC (2) 159691 SLEEVE 1.250 X 0.561 X 2.715 CZINC (2) 290024 WASHER .939" X .505 X .505 (2) 605011 5/16-18 X 0.750 HHCS GR8 YZINC (2) 605015 5/16-18 NYLOCK NUT GR5 CZINC (4) 605016 5/16 SAW FLAT WASHER GR8 YZINC (1) 605101 3/8-16 X 1.000 HHCS GR8 YZINC (1) 605121 3/8-16 NYLOCK NUT GR8 CZINC (2) 605133 3/8-16 SAE FLAT WASHER GR8 YZINC (1) 605202 7/16-14 X 1.250 HHCS GR8 YZINC (1) 605220 7/16-14 NYLOCK NUT GR8 YZINC	(2) 605300 1/2-13 X 1.000 HHCS GR8 YZINC (4) 605301 1/2-13 X 1.250 HHCS GR8 YZINC (6) 605321 1/2-13 NYLOCK NUT GR8 YZINC (12) 605330 1/2 SAE FLAT WASHER GR8 YZINC (2) 605443 9/16-12 X 4.500 HHCS GR8 YZINC (1) 605445 9/16-12 X 3.000 HHCA GR8 YZINC (6) 605455 9/16 FLAT WASHER YZINC (3) 605450 9/16-12 C-LOCK NUT GR5 CZINC (2) 605926-BLK 5-1/2 X 0.14 NYLON CABLE TIE, BLACK
---	---

TOOLS REQUIRED

JACK JACK STAND RATCHET EXTENSIONS TORQUE WRENCH HAMMER / DEADBLOW HAMMER PLIERS 1/2 SOCKET / WRENCH 9/16 SOCKET / WRENCH	5/8 SOCKET / WRENCH 3/4 SOCKET / WRENCH 13/16 SOCKET / WRENCH 7/8 SOCKET / WRENCH 8MM SOCKET / WRENCH 10MM SOCKET / WRENCH 17MM SOCKET / WRENCH 19MM SOCKET / WRENCH
---	---

TECH NOTES

1. ESTIMATED INSTALL TIME: 3-4 HOURS.
2. NOT COMPATIBLE WITH AVS EQUIPPED TRUCKS.
3. NOT COMPATIBLE WITH AIR RIDE EQUIPPED TRUCKS.
4. NOT COMPATIBLE WITH TRD PRO



WARNING!

**** READ ALL INSTRUCTIONS THOROUGHLY FROM START TO FINISH BEFORE BEGINNING INSTALLATION! IF THESE INSTRUCTIONS ARE NOT PROPERLY FOLLOWED SEVERE FRAME, SUSPENSION AND TIRE DAMAGE MAY RESULT TO THE VEHICLE!**

**** ICON VEHICLE DYNAMICS RECOMMENDS THAT YOU EXERCISE EXTREME CAUTION WHEN WORKING UNDER A VEHICLE THAT IS SUPPORTED WITH JACK STANDS.**

**** ICON VEHICLE DYNAMICS RECOMMENDS ALL INSTALLATION TO BE PERFORMED BY A PROFESSIONAL SHOP/SERVICE TECHNICIAN. PRODUCT FAILURE CAUSED BY IMPROPER INSTALLATION WILL NOT BE COVERED UNDER ICON'S WARRANTY POLICY.**

INSTALLATION

1. Place truck on flat ground, engage parking brake, block tires.
2. Remove the track bar before lifting the vehicle, as the track bar is under less load now and is easier to remove. Use a 19mm.

3. Lift rear of vehicle and place jack stands under the frame. The floor jack can be used under the axle for future steps. Do not work under an unsupported vehicle. Remove rear tires. Removing the spare tire can make this easier, refer to owners manual.

4. Remove the rear shocks, using a 17mm for the lower mounting stud, and a 8mm and 19mm for the upper bushing mount. Support the rear axle so it does not drop. [FIGURE 1 & 2]

FIG.1



FIG.2



5. Loosen and remove the brake line brackets from the frame and passenger upper link mount using a 10mm. [FIGURE 3 & 4]

FIG.3



FIG.4



6. Using a 10mm, loosen and remove the brake line clamp from the backside of the center of the axle. The clamp will need to be spread and removed from the line, then flipped over and reattached. The same will need to be done for the clamp that is attached to the backside of the passenger upper link mount. [FIGURE 5 & 6]

FIG.5



FIG.6



7. Remove the E-locker wiring bracket from the frame using a 10mm.

8. Install the upper ICON brake line drop bracket onto the frame using the OEM hardware. Torque the bolt to 80 in/lbs. Then secure the OEM brake line bracket to the ICON bracket using a 5/16-18 x .750 bolt, washers and nylock nut. Torque to 10 ft-lbs. [FIGURE 7]

FIG.7



9. Install the ICON lower bracket line riser to the upper link mount using the OEM hardware and torque to 80/in lbs. Then secure the OEM brake line bracket to the ICON bracket using a 5/16-18 x .750 bolt, washers and nylock nut. Torque to 10 ft-lbs. [FIGURE 8 & 9]

FIG.8



FIG.9



10. Slowly lower the axle down to free the coil springs. Set them aside, they will be reused if spring spacers were ordered. The left/right springs are the same. You can label them if you feel the need to.

11. Remove the upper link from the axle mount using a 19mm. Loosen the bolt and not the nut. The nut has small tangs that dig into the mount and act as a locking nut. If you loosen the nut, it will become damaged. [FIGURE 10]

FIG.10

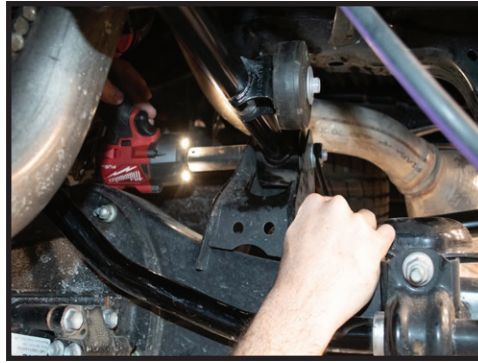

12. Loosen the frame side pivot also. You can leave the bolt in place if you are not installing Icon links. [FIGURE 11]

FIG.11



13. Install the upper link bracket from the kit as shown. Using the supplied 1/2-13 x 1.25" bolts with washers and nylock nuts on the lower holes. Use the longer sleeve (2.715") to put in place of the link and the 9/16-12 x 4.5" bolt with washers and c-lock nut to secure the spacer and bracket. Reinstall the upper link into the new mounting position using the factory hardware. Torque the 1/2" bolts to 80 ft-lbs. Torque the 9/16" bolt to 110 ft-lbs. If ICON links were installed torque the OEM bolts to 110 ft-lbs now. If OEM links are installed, wait until the truck is under its own weight to torque, as the bushings can be damaged if torqued now. [FIGURE 12 & 13]

FIG.12

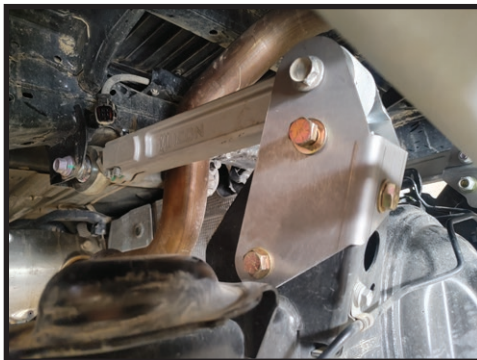

FIG.13



14. Install the trackbar bracket as shown. Use the 7/16-14 x 1.25" with washer and nylock nut. The bolt goes in from the top and the nut will need to be held with a pliers through the slot in the back of the axle mount. Depending on the truck, a pry bar might be needed to open the slot up and allow the nut to fit. Use the 3/8-16 x 1" bolt, washers and nylock nut to secure the bracket to the front side of the axle mount.

Use the OEM bolt and the remaining sleeve (1.580") and loosely secure it into the factory position. Then use the 9/16-12 x 3" bolt, washers and c-lock nut to secure the track bar into the ICON bracket. Torque the 9/16 bolt to 110 ft-lbs. Torque the 7/16" bolt to 50 ft-lbs. Torque the 3/8" bolt to 30 ft-lbs. Torque the OEM bolt to 110 ft-lbs (Icon track bar can be torqued now, OEM trackbar needs to be torqued once the truck is under its own weight). [FIGURE 14 & 15]

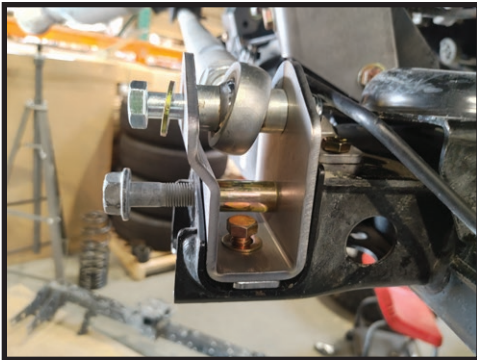

FIG.14



FIG.15

15. Loosen and remove the sway bar links from the frame mounts using a 17mm. Then remove the mount from the frame using a 17mm. The bolts will be reused. [FIGURE 16 & 17]



FIG.16



FIG.17

16. Install the new sway bar link mounts to the frame as shown. Use the OEM hardware and torque to 70 ft-lbs. Torque the Sway bar link nut to 50 ft-lbs. [FIGURE 18 & 19]



FIG.18

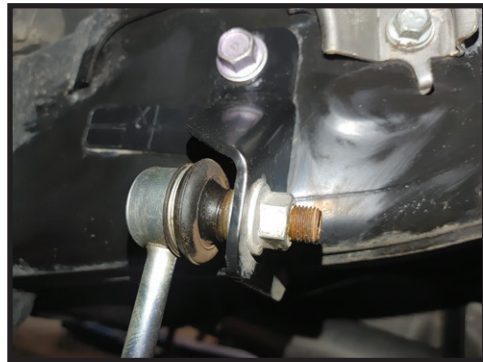

FIG.19

17. Loosen the lower link bolt at the axle, leave the bolt in place and remove the nut. The bolt has to be loosened or the nut may be damaged if rotated while tight. Slide the supplied bump stop bracket over the bolt and axle, reinstall the nut. Install the supplied 1/2-13 x 1.25" bolt with washer through the slotted hole in the bracket. Install the 1/2" black washer along with the gold washer and nylock nut. Torque to 70 ft-lbs. Torque the OEM bolt to 90 ft-lbs. [FIGURE 20 & 21]

FIG.20

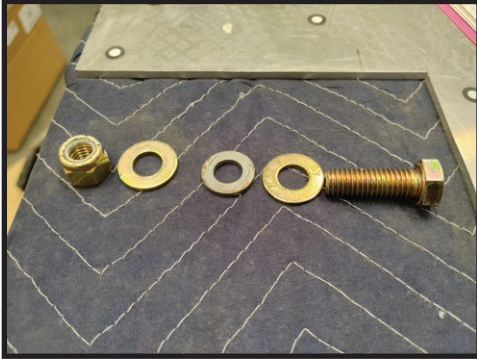

FIG.21



18. If the ICON coil springs were purchased, install those now. Refer to those instructions.

19. If spring spacers are to be used, install those now. They are identical left to right. Use the supplied 7/16-14 x 1.25 bolts and washers. The nut plate will be placed on top of the coil bucket. Tighten the bolts to 50 ft-lbs. Install the coil bumpstop into the coil and insert the coil spring back into position. Be sure the lower pig tail fits into the axle perch correctly. [FIGURE 22]

FIG.22

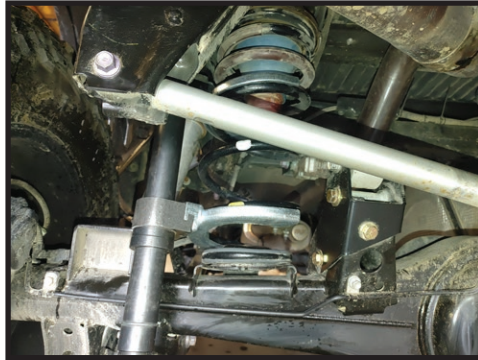

20. Install the new ICON shocks now, refer to the instructions included with the shocks.

21. Install wheels and tires.

22. Lower vehicle to the ground and torque the remaining bolts, if OEM links or trackbar were retained.

VERIFY ALL FASTENERS ARE PROPERLY TORQUED BEFORE DRIVING VEHICLE.

RETORQUE ALL NUTS, BOLTS AND LUGS AFTER 100 MILES AND PERIODICALLY THEREAFTER.

ICON VEHICLE DYNAMICS LIMITED LIFETIME WARRANTY

ICON Vehicle Dynamics warrants to the original retail purchaser who owns the vehicle on which the product was originally installed. ICON Vehicle Dynamics does not warrant the product for finish, alterations, modifications and/or installation contrary to ICON Vehicle Dynamics instructions. ICON Vehicle Dynamics products are not designed, nor are they intended to be installed on vehicles used in race applications, for racing purposes or for similar activities. (A "race" is defined as any contest between two or more vehicles, or a contest of one or more vehicles against the clock, whether or not such contest is for a prize). This warranty does not include coverage for police or taxi vehicles, race vehicles, or vehicles used for government or commercial purposes. Also excluded from this warranty are sales outside of the United States of America and Canada.

ICON Vehicle Dynamics' obligation under this warranty is limited to the repair or replacement, at ICON Vehicle Dynamics' discretion, of the defective product. Any and all costs of removal, installation or re-installation, freight charges and incidental or consequential damages are expressly excluded from this warranty. Items that are subject to wear are not considered defective when worn and are not covered.

ICON Vehicle Dynamics components must be installed as a complete kit as shown in our current application guide. Any substitutions or exemptions of required components will immediately void the warranty. Some finish damage may happen to parts during shipping and is not covered under warranty.

This warranty is expressly in lieu of all other warranties expressed or implied. This warranty shall not apply to any product that has been improperly installed, modified or customized subject to accident, negligence, abuse or misuse.

7929 Lincoln Ave. Riverside, CA 92504
Phone: 951.689.ICON | Fax: 951.689.1016

PART #	DESCRIPTION
51013	22-23 TUNDRA REAR 3.5 COIL SPRING KIT

COMPONENTS INCLUDED	
(2) 158202 22 TUNDRA 3.5" LIFT REAR COIL SPRING	
HARDWARE INCLUDED	
N/A	
TOOLS REQUIRED	
JACK JACK STANDS TORQUE WRENCH RATCHETS	12MM SOCKET/WRENCH 17MM SOCKET / WRENCH COIL SPRING COMPRESSOR
TECH NOTES	
1. .5" LIFT ON NON TRD MODELS ONLY.	
2. WILL NOT WORK ON AIR RIDE EQUIPPED VEHICLES.	
3. ESTIMATED INSTALL TIME: 2 HOURS.	



WARNING!

**** READ ALL INSTRUCTIONS THOROUGHLY FROM START TO FINISH BEFORE BEGINNING INSTALLATION! IF THESE INSTRUCTIONS ARE NOT PROPERLY FOLLOWED SEVERE FRAME, SUSPENSION AND TIRE DAMAGE MAY RESULT TO THE VEHICLE!**

**** ICON VEHICLE DYNAMICS RECOMMENDS THAT YOU EXERCISE EXTREME CAUTION WHEN WORKING UNDER A VEHICLE THAT IS SUPPORTED WITH JACK STANDS.**

**** ICON VEHICLE DYNAMICS RECOMMENDS ALL INSTALLATION TO BE PERFORMED BY A PROFESSIONAL SHOP/SERVICE TECHNICIAN. PRODUCT FAILURE CAUSED BY IMPROPER INSTALLATION WILL NOT BE COVERED UNDER ICON'S WARRANTY POLICY.**

INSTALLATION

1. Place vehicle in park on a level surface. Engage parking brake. Block the front tires. Lift rear of vehicle and place jack stands under the manufacturer recommended locations. NEVER WORK UNDER AN UNSUPPORTED VEHICLE.

2. Leave all brackets attached. Remove the lower shock mount with a 17mm and lower the axle, being sure not to overextend any brake lines or wiring harness. [FIGURE 1]



FIG.1

3. Use a spring compressor such as the one pictured. [FIGURE 2]



FIG.2

4. Install spring compressor with appropriate spring attachment and tighten to compress the spring until it can be removed. [FIGURE 3]

FIG.3



5. Remove the spring compressor from the factory spring and install it onto the new ICON spring.
6. Remove the bump stop cone from the factory spring and install it into the new ICON spring. Compress the spring enough so that it can be installed into the truck, making sure the spring seats into the upper and lower spring perch correctly. Repeat on passenger side.
7. Reinstall shock mounts, and torque to factory specification.
8. Reinstall wheels and tires, enjoy your new springs and ride.

**VERIFY ALL FASTENERS ARE PROPERLY TORQUED BEFORE DRIVING VEHICLE.
RETORQUE ALL NUTS, BOLTS AND LUGS AFTER 100 MILES AND PERIODICALLY THEREAFTER.**

ICON VEHICLE DYNAMICS LIMITED LIFETIME WARRANTY

ICON Vehicle Dynamics warrants to the original retail purchaser who owns the vehicle on which the product was originally installed. ICON Vehicle Dynamics does not warrant the product for finish, alterations, modifications and/or installation contrary to ICON Vehicle Dynamics instructions. ICON Vehicle Dynamics products are not designed, nor are they intended to be installed on vehicles used in race applications, for racing purposes or for similar activities. (A "race" is defined as any contest between two or more vehicles, or a contest of one or more vehicles against the clock, whether or not such contest is for a prize). This warranty does not include coverage for police or taxi vehicles, race vehicles, or vehicles used for government or commercial purposes. Also excluded from this warranty are sales outside of the United States of America and Canada.

ICON Vehicle Dynamics' obligation under this warranty is limited to the repair or replacement, at ICON Vehicle Dynamics' discretion, of the defective product. Any and all costs of removal, installation or re-installation, freight charges and incidental or consequential damages are expressly excluded from this warranty. Items that are subject to wear are not considered defective when worn and are not covered.

ICON Vehicle Dynamics components must be installed as a complete kit as shown in our current application guide. Any substitutions or exemptions of required components will immediately void the warranty. Some finish damage may happen to parts during shipping and is not covered under warranty.

This warranty is expressly in lieu of all other warranties expressed or implied. This warranty shall not apply to any product that has been improperly installed, modified or customized subject to accident, negligence, abuse or misuse.



ICON VEHICLE DYNAMICS®
PERFORMANCE SUSPENSION SYSTEMS AND SHOCK ABSORBERS

7929 Lincoln Ave. Riverside, CA 92504 Phone: 951.689.ICON Fax: 951.689.1016
www.iconvehicledynamics.com



FOLLOW US ON FACEBOOK!



7929 Lincoln Ave. Riverside, CA 92504
Phone: 951.689.ICON | Fax: 951.689.1016

PART #	DESCRIPTION
54002	22-UP TUNDRA BILLET LOWER LINK KIT

COMPONENTS INCLUDED	
(2) 157552 22-UP TUNDRA REAR LOWER LINK (2) 157546 22-UP TUNDRA SERRATED SPACER .259 (2) 157548 22-UP TUNDRA SERRATED SLEEVE .259 (2) 157420 NUT PLATE 3/8-16 X 2 (4) 157551 HEIM SPACER 1.00 X .559 X 2.834	(2) 167014 L/R ADJUSTER SLEEVE 1.25-12L / 1.00-14 (2) 127205 16.6" TRAILING ARM WEAR STRIP (2) 295510 JM16-1T 1-14 RH ROD END F2 FIT (2) 297102 GREASELESS PRESS IN BUSHING 2.135 X 14.3 X 58.85MM
HARDWARE INCLUDED	
(14) 605018 10-32 X .438 FLAT HEAD SCREW STAINLESS	(4) 605146 3/8-16 X 1.5 12 PT FLANGED CAP SCREW
TOOLS REQUIRED	
JACK JACK STANDS TORQUE WRENCH	19MM SOCKET / WRENCH 3/8 12-PT SOCKET / WRENCH
TECH NOTES	
<p>1. DO NOT EXCEED 3.375" ADJUSTMENT FROM THE CENTER OF THE ROD END TO THE EDGE OF THE BILLET LINK. FAILURE CAUSED BY EXCESSIVE ADJUSTMENT WILL NOT BE COVERED UNDER ICON'S WARRANTY POLICY.</p> <p>2. LINKS ARE PRESET TO 26.938" (FACTORY LENGTH).</p> <p>3. IF CUSTOM PINION ANGLE IS DESIRED YOU CAN ADJUST THIS WITH THE VEHICLE ON THE GROUND.</p>	

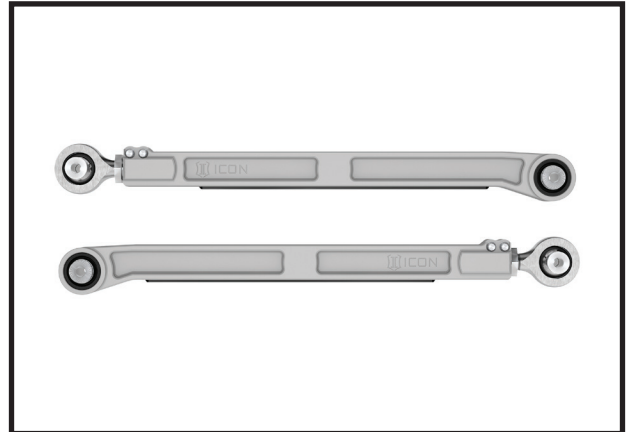

WARNING!
<p>** READ ALL INSTRUCTIONS THOROUGHLY FROM START TO FINISH BEFORE BEGINNING INSTALLATION! IF THESE INSTRUCTIONS ARE NOT PROPERLY FOLLOWED SEVERE FRAME, SUSPENSION AND TIRE DAMAGE MAY RESULT TO THE VEHICLE!</p> <p>** ICON VEHICLE DYNAMICS RECOMMENDS THAT YOU EXERCISE EXTREME CAUTION WHEN WORKING UNDER A VEHICLE THAT IS SUPPORTED WITH JACK STANDS.</p> <p>** ICON VEHICLE DYNAMICS RECOMMENDS ALL INSTALLATION TO BE PERFORMED BY A PROFESSIONAL SHOP/SERVICE TECHNICIAN. PRODUCT FAILURE CAUSED BY IMPROPER INSTALLATION WILL NOT BE COVERED UNDER ICON'S WARRANTY POLICY.</p>

INSTALLATION

1. Lift vehicle and securely place heavy duty jack stands under the manufacturer recommended lifting locations for the back of the vehicle. NEVER WORK UNDER AN UNSUPPORTED VEHICLE. Remove the wheels.

2. Remove the driver side rear upper link using a 19mm. [FIGURE 1]



FIG.1

3. Install the billet link with the heim joint toward the frame and the pinch bolts up. The pinch bolts should be on the outer side of the link. Tighten the factory hardware to factory spec using a 19mm. [FIGURE 2]



FIG.2

4. Repeat steps on opposite side of vehicle.
5. To adjust, loosen the pinch bolts billet link using a 3/8" 12pt. Turn the L/R adjusting collar until desired length is reached.
6. Make sure that the slit in the collar is lined up with the slit in the pinch housing and tighten pinch bolts using an alternating pattern [Torque to 40 ft-lbs]. Go back and forth between bolts 3 times to torque equally.
7. Never exceed the maximum length as listed in the tech notes

[TECH NOTE #1]

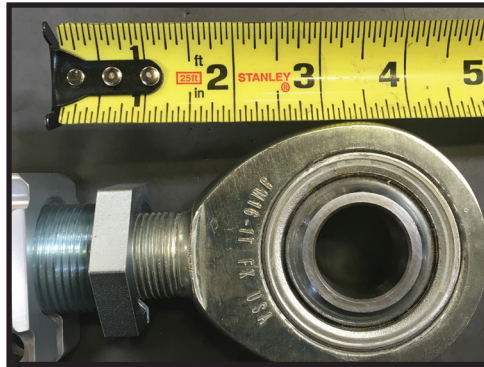

VERIFY ALL FASTENERS ARE PROPERLY TORQUED BEFORE DRIVING VEHICLE.

RETORQUE ALL NUTS, BOLTS AND LUGS AFTER 100 MILES AND PERIODICALLY THEREAFTER.

ICON VEHICLE DYNAMICS LIMITED LIFETIME WARRANTY

ICON Vehicle Dynamics warrants to the original retail purchaser who owns the vehicle on which the product was originally installed. ICON Vehicle Dynamics does not warrant the product for finish, alterations, modifications and/or installation contrary to ICON Vehicle Dynamics instructions. ICON Vehicle Dynamics products are not designed, nor are they intended to be installed on vehicles used in race applications, for racing purposes or for similar activities. (A "race" is defined as any contest between two or more vehicles, or a contest of one or more vehicles against the clock, whether or not such contest is for a prize). This warranty does not include coverage for police or taxi vehicles, race vehicles, or vehicles used for government or commercial purposes. Also excluded from this warranty are sales outside of the United States of America and Canada.

ICON Vehicle Dynamics' obligation under this warranty is limited to the repair or replacement, at ICON Vehicle Dynamics' discretion, of the defective product. Any and all costs of removal, installation or re-installation, freight charges and incidental or consequential damages are expressly excluded from this warranty. Items that are subject to wear are not considered defective when worn and are not covered.

ICON Vehicle Dynamics components must be installed as a complete kit as shown in our current application guide. Any substitutions or exemptions of required components will immediately void the warranty. Some finish damage may happen to parts during shipping and is not covered under warranty.

This warranty is expressly in lieu of all other warranties expressed or implied. This warranty shall not apply to any product that has been improperly installed, modified or customized subject to accident, negligence, abuse or misuse.



7929 Lincoln Ave. Riverside, CA 92504 Phone: 951.689.ICON Fax: 951.689.1016
www.iconvehicledynamics.com



FOLLOW US ON FACEBOOK!



7929 Lincoln Ave. Riverside, CA 92504
Phone: 951.689.ICON | Fax: 951.689.1016

PART #	DESCRIPTION
54102	22-UP TUNDRA BILLET UPPER LINK KIT

COMPONENTS INCLUDED	
(2) 157553 22-UP TUNDRA REAR UPPER LINK (2) 157547 22-UP TUNDRA SERRATED SPACER .200 (2) 157549 22-UP TUNDRA SERRATED SLEEVE .200 (2) 157420 NUT PLATE 3/8-16 X 2 (4) 157551 HEIM SPACER 1.00 X .559 X 2.834	(2) 167014 L/R ADJUSTER SLEEVE 1.25-12L / 1.00-14 (2) 295510 JM16-IT 1-14 RH ROD END F2 FIT (2) 297102 GREASELESS PRESS IN BUSHING 2.135 X 14.3 X 58.85MM
HARDWARE INCLUDED	
(4) 605146 3/8-16 X 1.5 12 PT FLANGED CAP SCREW	
TOOLS REQUIRED	
JACK JACK STANDS TORQUE WRENCH DIE GRINDER	PAINT PEN (BLACK) 19MM SOCKET / WRENCH 3/8 12-PT SOCKET / WRENCH
TECH NOTES	
<p>1. IF EQUIPPED WITH AIR RIDE SUSPENSION, KIT PN-55153 IS REQUIRED.</p> <p>2. DO NOT EXCEED 3.375" ADJUSTMENT FROM THE CENTER OF THE ROD END TO THE EDGE OF THE BILLET LINK. FAILURE CAUSED BY EXCESSIVE ADJUSTMENT WILL NOT BE COVERED UNDER ICON'S WARRANTY POLICY.</p> <p>3. LINKS ARE PRESET TO 15.438" (FACTORY LENGTH).</p> <p>4. IF CUSTOM PINION ANGLE IS DESIRED YOU CAN ADJUST THIS WITH THE VEHICLE ON THE GROUND.</p>	

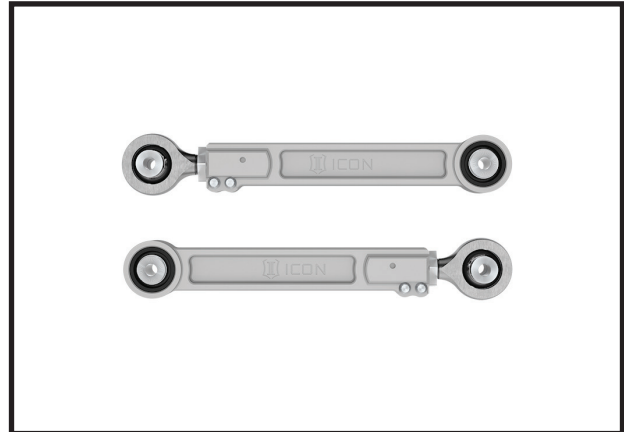

WARNING!
<p>** READ ALL INSTRUCTIONS THOROUGHLY FROM START TO FINISH BEFORE BEGINNING INSTALLATION! IF THESE INSTRUCTIONS ARE NOT PROPERLY FOLLOWED SEVERE FRAME, SUSPENSION AND TIRE DAMAGE MAY RESULT TO THE VEHICLE!</p> <p>** ICON VEHICLE DYNAMICS RECOMMENDS THAT YOU EXERCISE EXTREME CAUTION WHEN WORKING UNDER A VEHICLE THAT IS SUPPORTED WITH JACK STANDS.</p> <p>** ICON VEHICLE DYNAMICS RECOMMENDS ALL INSTALLATION TO BE PERFORMED BY A PROFESSIONAL SHOP/SERVICE TECHNICIAN. PRODUCT FAILURE CAUSED BY IMPROPER INSTALLATION WILL NOT BE COVERED UNDER ICON'S WARRANTY POLICY.</p>

INSTALLATION

- Lift vehicle and securely place heavy duty jack stands under the manufacturer recommended lifting locations for the back of the vehicle. NEVER WORK UNDER AN UNSUPPORTED VEHICLE. Remove the wheels.
- If the vehicle is equipped with air-ride suspension, refer to PN-55153 instructions for disconnecting the position sensing arm from the link.
- Remove the driver side rear upper link using a 19mm. [FIGURE 1 & 2]

FIG.1

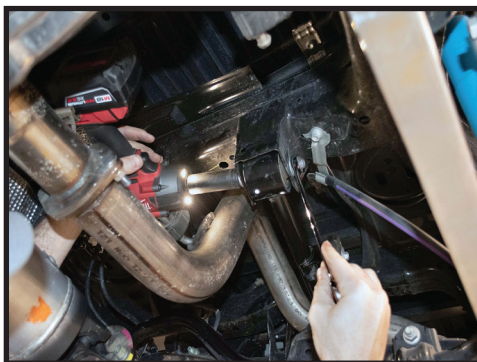
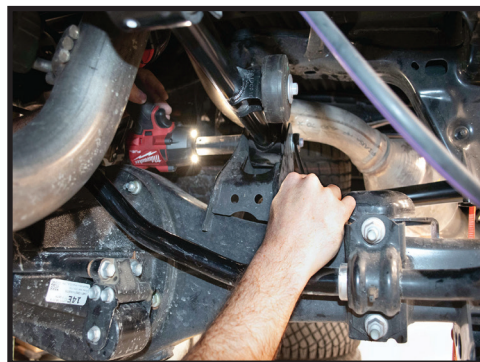

FIG.2



4. The pocket on the differential requires trimming for the billet link. Using a die grinder, grind the radius on the pocket gusset as shown. [FIGURE 3 & 4]

FIG.3

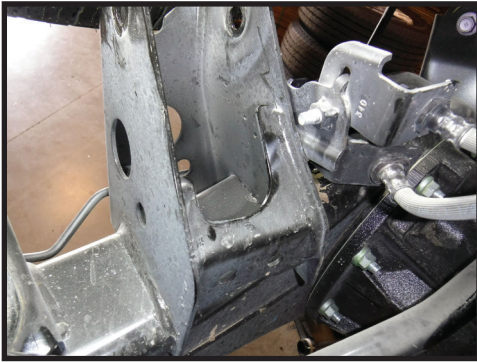
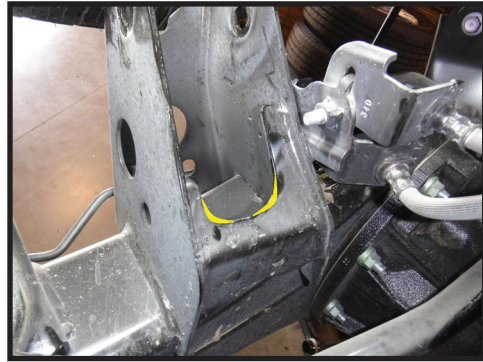

FIG.4



5. Paint exposed metal using a paint pen.

6. Install the billet link with the heim joint toward the frame and the pinch bolts down. The pinch bolts should be on the outer side of the link. Tighten the factory hardware to factory spec using a 19mm. [FIGURE 5]

FIG.5



7. Repeat steps on opposite side of vehicle.

8. To adjust, loosen the pinch bolts billet link using a 3/8" 12pt. Turn the L/R adjusting collar until desired length is reached.

9. Make sure that the slit in the collar is lined up with the slit in the pinch housing and tighten pinch bolts using an alternating pattern [Torque to 40 ft-lbs]. Go back and forth between bolts 3 times to torque equally.

10. Never exceed the maximum length as listed in the tech notes.

[TECH NOTE #1]

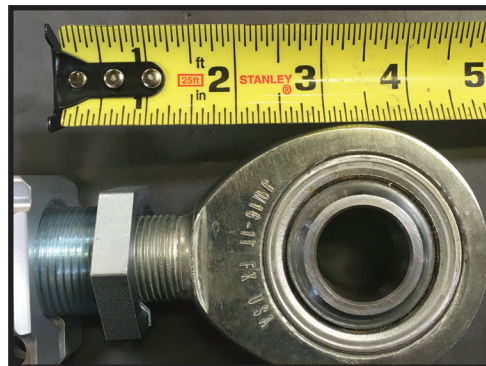

VERIFY ALL FASTENERS ARE PROPERLY TORQUED BEFORE DRIVING VEHICLE.

RETORQUE ALL NUTS, BOLTS AND LUGS AFTER 100 MILES AND PERIODICALLY THEREAFTER.

ICON VEHICLE DYNAMICS LIMITED LIFETIME WARRANTY

ICON Vehicle Dynamics warrants to the original retail purchaser who owns the vehicle on which the product was originally installed. ICON Vehicle Dynamics does not warrant the product for finish, alterations, modifications and/or installation contrary to ICON Vehicle Dynamics instructions. ICON Vehicle Dynamics products are not designed, nor are they intended to be installed on vehicles used in race applications, for racing purposes or for similar activities. (A "race" is defined as any contest between two or more vehicles, or a contest of one or more vehicles against the clock, whether or not such contest is for a prize). This warranty does not include coverage for police or taxi vehicles, race vehicles, or vehicles used for government or commercial purposes. Also excluded from this warranty are sales outside of the United States of America and Canada.

ICON Vehicle Dynamics' obligation under this warranty is limited to the repair or replacement, at ICON Vehicle Dynamics' discretion, of the defective product. Any and all costs of removal, installation or re-installation, freight charges and incidental or consequential damages are expressly excluded from this warranty. Items that are subject to wear are not considered defective when worn and are not covered.

ICON Vehicle Dynamics components must be installed as a complete kit as shown in our current application guide. Any substitutions or exemptions of required components will immediately void the warranty. Some finish damage may happen to parts during shipping and is not covered under warranty.

This warranty is expressly in lieu of all other warranties expressed or implied. This warranty shall not apply to any product that has been improperly installed, modified or customized subject to accident, negligence, abuse or misuse.



ICON VEHICLE DYNAMICS®
PERFORMANCE SUSPENSION SYSTEMS AND SHOCK ABSORBERS

7929 Lincoln Ave. Riverside, CA 92504 Phone: 951.689.ICON Fax: 951.689.1016
www.iconvehicledynamics.com



FOLLOW US ON FACEBOOK!



7929 Lincoln Ave. Riverside, CA 92504
Phone: 951.689.ICON | Fax: 951.689.1016

PART #	DESCRIPTION
54202	22-UP TUNDRA BILLET TRACK BAR KIT

COMPONENTS INCLUDED	
(1) 157555 22-UP TUNDRA ALUMINUM REAR TRACK BAR (4) 257432 HEIM SPACER JM12 X .562 X 1.965	(1) 295514 RSMX12T ROD END F1 FIT (1) 295532 RSMXL12T ROD END F1 FIT
HARDWARE INCLUDED	
(1) 605740 7/8-14 JAM NUT THIN	(1) 605741 7/8-14 LEFT HAND JAM NUT THIN
TOOLS REQUIRED	
TORQUE WRENCH 19MM SOCKET / WRENCH	1-5/16" SOCKET / WRENCH
TECH NOTES	
<p>1. TRACK BAR IS DESIGNED TO BE ADJUSTED ON THE VEHICLE WITH LEFT AND RIGHT HAND THREADS AT EACH END, THE WITNESS MARK AT THE END OF THE BAR INDICATES LEFT HAND THREAD. ADJUSTING IT OFF THE VEHICLE BY TURNING ONLY ONE ROD END WILL LEAD TO INCORRECT THREAD ENGAGEMENT AND FAILURE. ALWAYS ADJUST EQUALLY.</p> <p>2. SOLID MOUNTED ENDS INCREASE VEHICLE RESPONSE AND VEHICLE FEEDBACK BUT CAN GENERATE INCREASED ROAD NOISE.</p> <p>3. TRACK BAR SHOULD BE ADJUSTED ROUGHLY 1/16" LONGER FOR EACH INCH OF LIFT ASSUMING FACTORY TRACK BAR MOUNTING LOCATION. FINAL NUMBER DETERMINED BY PROFESSIONAL ALIGNMENT.</p> <p>4. TRACK BAR IS SET TO 41.938" (FACTORY LENGTH).</p> <p>5. DO NOT EXCEED 42.625" EYE TO EYE LENGTH.</p>	

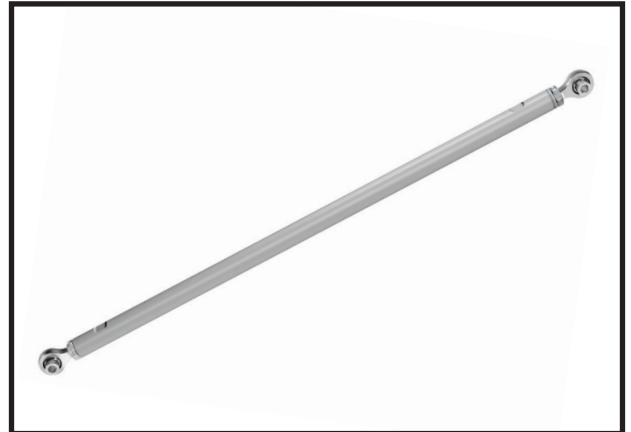

WARNING!
<p>** READ ALL INSTRUCTIONS THOROUGHLY FROM START TO FINISH BEFORE BEGINNING INSTALLATION! IF THESE INSTRUCTIONS ARE NOT PROPERLY FOLLOWED SEVERE FRAME, SUSPENSION AND TIRE DAMAGE MAY RESULT TO THE VEHICLE!</p> <p>** ICON VEHICLE DYNAMICS RECOMMENDS THAT YOU EXERCISE EXTREME CAUTION WHEN WORKING UNDER A VEHICLE THAT IS SUPPORTED WITH JACK STANDS.</p> <p>** ICON VEHICLE DYNAMICS RECOMMENDS ALL INSTALLATION TO BE PERFORMED BY A PROFESSIONAL SHOP/SERVICE TECHNICIAN. PRODUCT FAILURE CAUSED BY IMPROPER INSTALLATION WILL NOT BE COVERED UNDER ICON'S WARRANTY POLICY.</p>

INSTALLATION

1. Remove the factory track bar using a 19mm. [FIGURE 1 & 2]

FIG.1

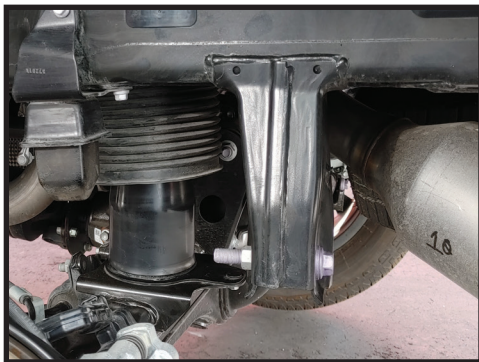

FIG.2



2. Install the billet track bar using the factory hardware and torque to factory spec using a 19mm. [FIGURE 3 & 4]

FIG.1



FIG.2



3. To adjust, loosen jam nuts using a 1-5/16" and turn the billet track bar. Once the differential is centered under the frame, torque the jam nuts to 180 ft-lbs.

4. Never exceed the maximum length as listed in the tech notes.

VERIFY ALL FASTENERS ARE PROPERLY TORQUED BEFORE DRIVING VEHICLE.

RETORQUE ALL NUTS, BOLTS AND LUGS AFTER 100 MILES AND PERIODICALLY THEREAFTER.

ICON VEHICLE DYNAMICS LIMITED LIFETIME WARRANTY

ICON Vehicle Dynamics warrants to the original retail purchaser who owns the vehicle on which the product was originally installed. ICON Vehicle Dynamics does not warrant the product for finish, alterations, modifications and/or installation contrary to ICON Vehicle Dynamics instructions. ICON Vehicle Dynamics products are not designed, nor are they intended to be installed on vehicles used in race applications, for racing purposes or for similar activities. (A "race" is defined as any contest between two or more vehicles, or a contest of one or more vehicles against the clock, whether or not such contest is for a prize). This warranty does not include coverage for police or taxi vehicles, race vehicles, or vehicles used for government or commercial purposes. Also excluded from this warranty are sales outside of the United States of America and Canada.

ICON Vehicle Dynamics' obligation under this warranty is limited to the repair or replacement, at ICON Vehicle Dynamics' discretion, of the defective product. Any and all costs of removal, installation or re-installation, freight charges and incidental or consequential damages are expressly excluded from this warranty. Items that are subject to wear are not considered defective when worn and are not covered.

ICON Vehicle Dynamics components must be installed as a complete kit as shown in our current application guide. Any substitutions or exemptions of required components will immediately void the warranty. Some finish damage may happen to parts during shipping and is not covered under warranty.

This warranty is expressly in lieu of all other warranties expressed or implied. This warranty shall not apply to any product that has been improperly installed, modified or customized subject to accident, negligence, abuse or misuse.



ICON VEHICLE DYNAMICS®
PERFORMANCE SUSPENSION SYSTEMS AND SHOCK ABSORBERS

7929 Lincoln Ave. Riverside, CA 92504 Phone: 951.689.ICON Fax: 951.689.1016
www.iconvehicledynamics.com



FOLLOW US ON FACEBOOK!



PART #	DESCRIPTION
57841CP	22-UP TUNDRA 6" REAR 2.5 VS RR CDCV PAIR

COMPONENTS INCLUDED	
(2) 154875C-AL 22 TUNDRA 6" REAR 2.5 VS CDCV UNPKG	(2) 250003 10.00 UNIVERSAL RESI MT PLATE CZINC
HARDWARE INCLUDED	
(2) 605144 3/8-12 X .750 FLANGED SELF TAP BOLT CZINC (2) 258000 2.5 X 13 URETHANE SHOCK BOOT BLACK	(2) 611008 9/16 RXT HEAVY DUTY STEM BUSHING KIT (2) 611051 #36 1.188-2.750 STAINLESS HOSE CLAMP KIT (4)
TOOLS REQUIRED	
JACK JACK STANDS TORQUE WRENCH RATCHETS EXTENSION DRILL 11/32 DRILL BIT	SHARPIE 8MM 17MM 19MM 9/16" 5/16" NUT DRIVER OR FLAT BLADE SCREW DRIVER
TECH NOTES	
<p>1. YOUR ICON SHOCK ASSEMBLIES COME FACTORY CHARGED TO 250 PSI. RELEASING NITROGEN PRESSURE MAY LEAD TO SHOCK MALFUNCTION AND REDUCED RIDE QUALITY. FAILURE CAUSED BY LOW NITROGEN PRESSURE IS NOT COVERED UNDER ICON'S WARRANTY POLICY.</p> <p>2. BE CAUTIOUS WHEN LOWERING THE AXLE WITHOUT THE SHOCKS ATTACHED, THE BRAKE LINES CAN BECOME STRETCHED AND CAUSE DAMAGE.</p> <p>3. ESTIMATED INSTALL TIME: 1.5 HOURS</p>	



WARNING!

**** READ ALL INSTRUCTIONS THOROUGHLY FROM START TO FINISH BEFORE BEGINNING INSTALLATION! IF THESE INSTRUCTIONS ARE NOT PROPERLY FOLLOWED SEVERE FRAME, SUSPENSION AND TIRE DAMAGE MAY RESULT TO THE VEHICLE!**

**** ICON VEHICLE DYNAMICS RECOMMENDS THAT YOU EXERCISE EXTREME CAUTION WHEN WORKING UNDER A VEHICLE THAT IS SUPPORTED WITH JACK STANDS.**

**** ICON VEHICLE DYNAMICS RECOMMENDS ALL INSTALLATION TO BE PERFORMED BY A PROFESSIONAL SHOP/SERVICE TECHNICIAN. PRODUCT FAILURE CAUSED BY IMPROPER INSTALLATION WILL NOT BE COVERED UNDER ICON'S WARRANTY POLICY.**

INSTALLATION

- To be used in conjunction with (51012) instructions.
- Install optional shock boot securing the top of the boot with the supplied zip-tie.
- Install the new Icon stem bushings onto the Icon shock. Place the washer with the bigger hole on, then a bushing. Place the stem into the upper shock mount, then another bushing and the washer, thread on one of the supplied nuts.



FIG.1

- Tighten the nut down until 3-4 threads show with both nuts installed. [FIGURE 1]

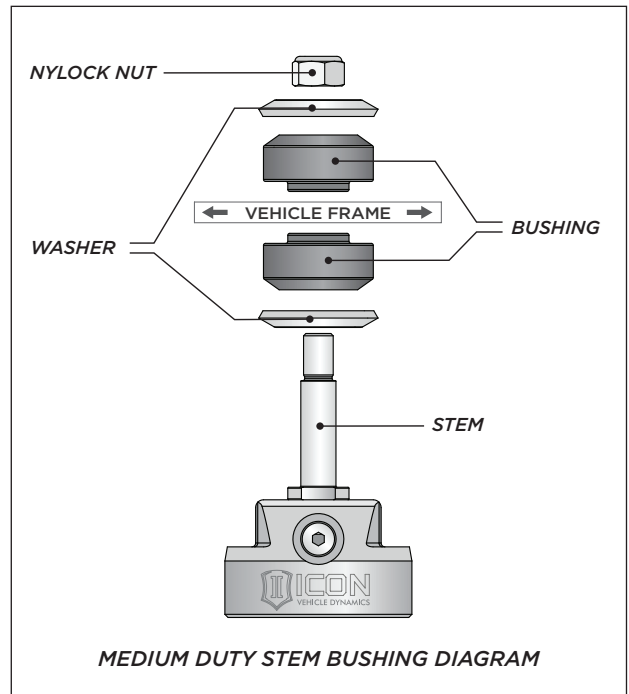

5. Install the lower eyelet of the Icon shock onto the axle stud. Use the supplied sleeves to position the eyelet correctly. Sleeve, shock eyelet, sleeve. Use the factory bolt and torque to factory specs. [FIGURE 2 & 3]

FIG.2



FIG.3



6. For reservoir mounting, use the supplied reservoir bracket and hold the reservoir and bracket up to the frame as shown, and mark the hole to drill it to 11/32" (SHOCK APPEARANCE MAY CHANGE DUE TO ONGOING DEVELOPMENT). [FIGURE 4, 5, 6]

FIG.4



FIG.5



FIG.6



7. With the hole drilled, take the supplied 3/8" self-tap flanged bolt and reservoir bracket and install onto the frame.

8. Using the supplied hose clamps, clamp the reservoir onto the bracket as shown (If desired, the supplied heat shrink material can be cut to fit over the hose clamps). [FIGURE 7, 8, 9, 10]

FIG.7



FIG.8



FIG.9



FIG.10

9. With the shocks installed. Refer back to (51012 instructions).



***VERIFY ALL FASTENERS ARE PROPERLY TORQUED BEFORE DRIVING VEHICLE.
RETORQUE ALL NUTS, BOLTS AND LUGS AFTER 100 MILES AND PERIODICALLY THEREAFTER.***

2.5 VS SERIES SHOCK & COILOVER TECHNICAL INFORMATION

MAINTENANCE

ICON shock absorbers are a high quality rebuildable race style shock absorber designed for optimal performance. With a unit of this caliber on your vehicle, routine maintenance is required to keep them looking and operating in like new condition. Residual oil and assembly lube may be present at all seal paths from the factory out of the box and is considered normal. Pooling of oil however is not acceptable at any time and one should contact the ICON dealer where purchased.

BELOW ARE GUIDELINES BASED ON HOW YOU USE YOUR VEHICLE BUT YOUR MILEAGE MAY VARY:

STREET USE:

- Send in for factory servicing every 40,000 miles or if a leak develops, ride quality decreases, or they begin to make excessive noise.
- Remove any buildup of road salt, mud, or debris from shocks and coil springs anytime accrued
- Clean with mild soap and water with each oil change or anytime you notice build up.
- Wax the cylinders yearly with automotive wax to prevent corrosion.
- Check nitrogen pressure yearly. (252004 charge needle assembly available at any ICON distributor)
- Check bearings for excessive wear yearly.
- DO NOT apply any type of lube to the upper and lower bearings.

STREET/DIRT:

- Send in for factory servicing every 15,000 miles or if a leak develops, ride quality decreases, or they begin to make excessive noise.
- Clean with mild soap and water with each oil change, offroad trip, or anytime you notice build up.
- Wax the cylinders yearly with automotive wax to prevent corrosion.
- Check nitrogen pressure each dirt outing. (252004 charge needle assembly available at any ICON distributor)
- Check bearings for excessive wear yearly.
- DO NOT apply any type of lube to the upper and lower bearings.

DIRT USE:

- Send in for factory servicing every 1,000 miles.
- Check nitrogen pressure each outing. (252004 charge needle assembly available at any ICON distributor)
- Remove any buildup of mud or debris from shocks and coil springs after every outing.

SELF-SERVICE:

- Contact ICON for service kits & tools at (951) 689-4266.

PRODUCT REGISTRATION

Please visit: <http://www.iconvehicledynamics.com/tech-support/registration/> to register your product.

ICON VEHICLE DYNAMICS SHOCK ABSORBER WARRANTY

This shock absorber has a 1 year warranty against any manufacturer's defects. If a shock fails within the initial year of ownership, the shock must be shipped to ICON Vehicle Dynamics for inspection and service. If a shock is inspected and it has been determined the shock failed due to neglect, damage caused by improper installation or any other reason besides "normal wear and tear", the owner of said shock is responsible for all service costs. This includes labor, parts, and shipping.

ICON Vehicle Dynamics warrants to the original retail purchaser who owns the vehicle on which the product was originally installed. ICON Vehicle Dynamics does not warrant the product for finish, alterations, modifications and/or installation contrary to ICON Vehicle Dynamics instructions. ICON Vehicle Dynamics products are not designed, nor are they intended to be installed on vehicles used in race applications, for racing purposes or for similar activities. (A "race" is defined as any contest between two or more vehicles, or a contest of one or more vehicles against the clock, whether or not such contest is for a prize). This warranty does not include coverage for police or taxi vehicles, race vehicles, or vehicles used for government or commercial purposes. Also excluded from this warranty are sales outside of the United States of America and Canada.

ICON Vehicle Dynamics' obligation under this warranty is limited to the repair or replacement, at ICON Vehicle Dynamics' discretion, of the defective product. Any and all costs of removal, installation or re-installation, freight charges and incidental or consequential damages are expressly excluded from this warranty. Items that are subject to wear are not considered defective when worn and are not covered.

ICON Vehicle Dynamics components must be installed as a complete kit as shown in our current application guide. Any substitutions or exemptions of required components will immediately void the warranty. Some finish damage may happen to parts during shipping and is not covered under warranty.

This warranty is expressly in lieu of all other warranties expressed or implied. This warranty shall not apply to any product that has been improperly installed, modified or customized subject to accident, negligence, abuse or misuse.

To send a shock in for warranty please visit our website <http://www.iconvehicledynamics.com/tech-support/shock-service/>



ICON VEHICLE DYNAMICS®
PERFORMANCE SUSPENSION SYSTEMS AND SHOCK ABSORBERS

7929 Lincoln Ave. Riverside, CA 92504 Phone: 951.689.ICON Fax: 951.689.1016
www.iconvehicledynamics.com



FOLLOW US ON FACEBOOK!



7929 Lincoln Ave. Riverside, CA 92504
 Phone: 951.689.ICON | Fax: 951.689.1016

PART #	DESCRIPTION
58561DJ	22-UP TOYOTA TUNDRA BILLET UCA KIT

COMPONENTS INCLUDED	
(1) 157619 22-UP TUNDRA BILLET UCA DRVR	(1) 157620 22-UP TUNDRA BILLET UCA PASS
HARDWARE INCLUDED	
(4) 157509 HEIM SPACER JM12 X 16MM X 1.875 CZINC (4) 157510 HEIM SPACER JM12 X 16MM X 2.875 CZINC	(2) 297165 DELTA PRO BILLET UCA DUST COVER (8) 605002 6-32 X 0.500 SHCS 18-8 RAW (2) 605890 M14 FENDER WASHER 36MM OD (1) 605968 VIBRATITE BLUE 2ML BULLET
TOOLS REQUIRED	
JACK JACK STANDS #2 PHILLIPS SCREWDRIVER BODY CLIP REMOVAL TOOL SMALL FLAT BLADE SCREWDRIVER NEEDLE NOSE PLIERS TORQUE WRENCH	10MM SOCKET / WRENCH 12MM SOCKET / WRENCH 19MM SOCKET / WRENCH 22MM SOCKET / WRENCH 3/8 12-PT
TECH NOTES	
<p>1. DO NOT EXCEED 1.875" ADJUSTMENT FROM THE CENTER OF THE ROD END TO THE EDGE OF THE BILLET UPPER CONTROL ARM. FAILURE CAUSED BY EXCESSIVE ADJUSTMENT WILL NOT BE COVERED UNDER ICON'S WARRANTY POLICY. REFER TO TECH NOTE PHOTO.</p> <p>2. ICON DELTA JOINTS ARE PRE-GREASED FROM THE FACTORY. ICON RECOMMENDS GREASING THE DELTA JOINT EVERY 3,000 MILES (OR EVERY OIL CHANGE). ADD NEW GREASE UNTIL ALL OF THE OLD GREASE IS EXPELLED FROM THE BOTTOM OF THE DELTA JOINT ASSEMBLY, WIPE AWAY EXCESS WITH A RAG OR SHOP TOWEL.</p> <p>3. ALL ICON UPPER CONTROL ARMS HAVE BEEN ENGINEERED TO ALLOW FOR THE MOST POSSIBLE CASTER, WHILE STILL ALLOWING THE VEHICLE TO BE PROPERLY ALIGNED. NOTIFY YOUR PROFESSIONAL ALIGNMENT SHOP OF THIS INFORMATION SO THAT MAXIMUM RIDE QUALITY CAN BE ACHIEVED.</p> <p>4. ESTIMATED INSTALL TIME: 3 HOURS</p>	

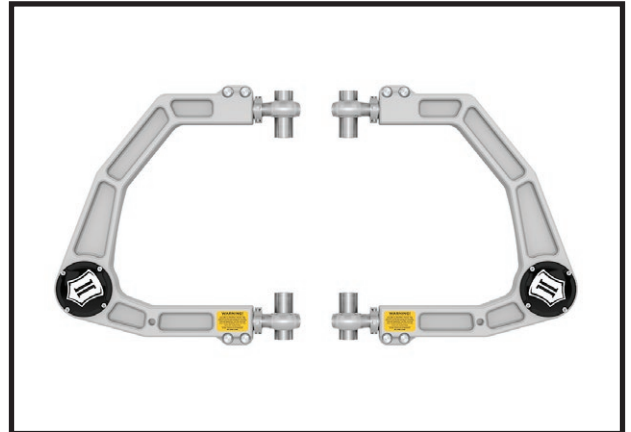

WARNING!
<p>** READ ALL INSTRUCTIONS THOROUGHLY FROM START TO FINISH BEFORE BEGINNING INSTALLATION! IF THESE INSTRUCTIONS ARE NOT PROPERLY FOLLOWED SEVERE FRAME, SUSPENSION AND TIRE DAMAGE MAY RESULT TO THE VEHICLE!</p> <p>** ICON VEHICLE DYNAMICS RECOMMENDS THAT YOU EXERCISE EXTREME CAUTION WHEN WORKING UNDER A VEHICLE THAT IS SUPPORTED WITH JACK STANDS.</p> <p>** ICON VEHICLE DYNAMICS RECOMMENDS ALL INSTALLATION TO BE PERFORMED BY A PROFESSIONAL SHOP/SERVICE TECHNICIAN. PRODUCT FAILURE CAUSED BY IMPROPER INSTALLATION WILL NOT BE COVERED UNDER ICON'S WARRANTY POLICY.</p>

INSTALLATION

- Lift vehicle and securely place heavy duty jack stands under the manufacturer recommended lifting locations for the front of the vehicle. Take care when lifting the vehicle, and allow 3-4" of ground clearance from the tire. Remove front tires. NEVER WORK UNDER AN UNSUPPORTED VEHICLE. Remove the wheels.
- Open the hood and disconnect the negative terminal on the battery using a 12mm and unplug the electrical connector.
- Unplug the electrical connector on the air intake tube. [FIGURE 1]



FIG.1

- Remove the airbox. Loosen the hose clamp with a #2 phillips screwdriver or 10mm on the air intake hose located closest to the engine. [FIGURE 2]



FIG.2

5. Lift up on box and remove. The box is only held in place by the intake tube and rubber grommets underneath.

6. With the box removed, remove the wiring clips from the ECU bracket. [FIGURE 3 & 4]

FIG.3



FIG.4



7. Unplug the small grey connector next to the ECU.

8. Unplug the ECU harnesses from the ECU. Push down on the safety latch and push the lever the opposite way. The connector will lift up and you will be able to remove it completely. [FIGURE 5 & 6]

FIG.5

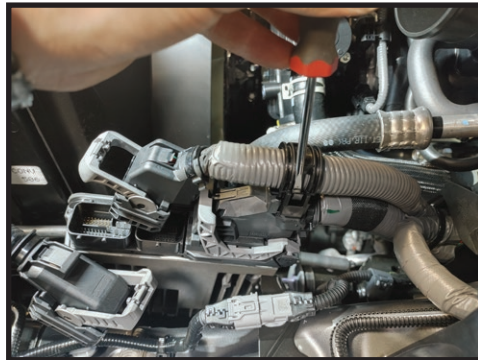

FIG.6



9. Remove the harness clamp from the large wire loom using a small flat blade screwdriver. [FIGURE 7]

FIG.7



10. Remove the large harness from the ECU. Press lock clip and pull up on the grey lever and pulling plug out. [FIGURE 8]

FIG.8



11. Remove 3 10mm bolts from the ECU bracket. One on the front core support, two on the fender well. [FIGURE 9 & 10]

FIG.9

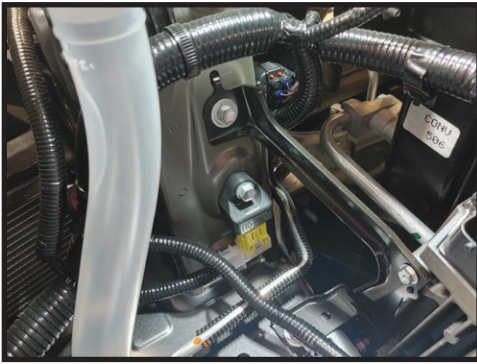
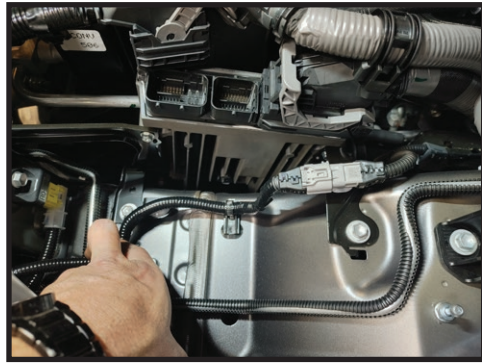

FIG.10



12. Remove the splash guards from the fender well using a needle nose pliers to pinch the clip and pull out. [FIGURE 11]

FIG.11



13. Remove the 12mm bolt from the top of the UCA that holds the ABS wire. [FIGURE 12]

FIG.12



14. Remove the cotter pin from the UCA balljoint using a small screwdriver or pick to pry over the safety clip and pull out the pin using a needle nose pliers. Loosen the 19mm nut on the balljoint. [FIGURE 13 & 14]

FIG.13



FIG.14



15. Use a hammer or balljoint separator to loosen the balljoint taper from the spindle. [FIGURE 15]

FIG.15



16. Loosen and remove the UCA pivot bolt from the frame using a 22mm. [FIGURE 16]

FIG.16



17. Remove the factory UCA. [FIGURE 17]

FIG.17



18. Prepare Icon Billet UCA for install. Be sure the heim spacers are correctly installed. Refer to photo. [FIGURE 18]

FIG.18



19. Install the ICON UCA into position and slide the factory mounting bolt through the heims, spacers and frame. [FIGURE 19 & 20]

FIG.19

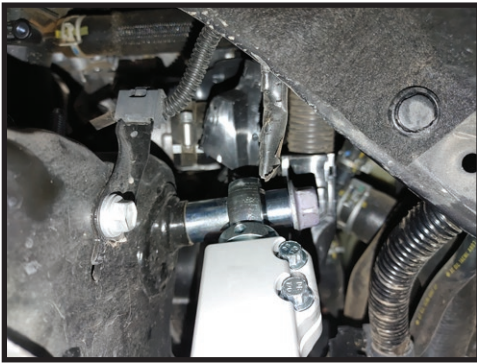

FIG.20



20. Install the Delta Joint Pro into the spindle, apply included blue thread locker to threads on flange nut and thread on to Delta Joint Pro with washer (605890) between the flange nut and spindle [Torque the nut to 70 ft-lbs]. [FIGURE 21]

FIG.21



21. Install the ABS bracket onto the Billet UCA using the factory bolt. [FIGURE 22]

FIG.22



22. Torque the factory long pivot bolt to OEM spec.

23. Install the supplied delta joint dust cap and o-ring using the four 6-32 x .500 stainless screws with a small amount of blue thread locker to the threads. [FIGURE 23]

FIG.23



24. Reinstall the ECU and airbox in reverse order of removal.
25. Repeat steps 12-21 on passenger side.
26. Reinstall wheels and tires and carefully lower vehicle to the ground. Torque lug nuts to factory spec.

[TECH NOTE #1]



VERIFY ALL FASTENERS ARE PROPERLY TORQUED BEFORE DRIVING VEHICLE.

RETORQUE ALL NUTS, BOLTS AND LUGS AFTER 100 MILES AND PERIODICALLY THEREAFTER.

ICON VEHICLE DYNAMICS LIMITED LIFETIME WARRANTY

ICON Vehicle Dynamics warrants to the original retail purchaser who owns the vehicle on which the product was originally installed. ICON Vehicle Dynamics does not warrant the product for finish, alterations, modifications and/or installation contrary to ICON Vehicle Dynamics instructions. ICON Vehicle Dynamics products are not designed, nor are they intended to be installed on vehicles used in race applications, for racing purposes or for similar activities. (A "race" is defined as any contest between two or more vehicles, or a contest of one or more vehicles against the clock, whether or not such contest is for a prize). This warranty does not include coverage for police or taxi vehicles, race vehicles, or vehicles used for government or commercial purposes. Also excluded from this warranty are sales outside of the United States of America and Canada.

ICON Vehicle Dynamics' obligation under this warranty is limited to the repair or replacement, at ICON Vehicle Dynamics' discretion, of the defective product. Any and all costs of removal, installation or re-installation, freight charges and incidental or consequential damages are expressly excluded from this warranty. Items that are subject to wear are not considered defective when worn and are not covered.

ICON Vehicle Dynamics components must be installed as a complete kit as shown in our current application guide. Any substitutions or exemptions of required components will immediately void the warranty. Some finish damage may happen to parts during shipping and is not covered under warranty.

This warranty is expressly in lieu of all other warranties expressed or implied. This warranty shall not apply to any product that has been improperly installed, modified or customized subject to accident, negligence, abuse or misuse.



ICON VEHICLE DYNAMICS®
PERFORMANCE SUSPENSION SYSTEMS AND SHOCK ABSORBERS

7929 Lincoln Ave. Riverside, CA 92504 Phone: 951.689.ICON Fax: 951.689.1016
www.iconvehicledynamics.com



FOLLOW US ON FACEBOOK!



7929 Lincoln Ave. Riverside, CA 92504
 Phone: 951.689.ICON | Fax: 951.689.1016

PART #	DESCRIPTION
58771C	22-UP TUNDRA 2.5 VS RR CDCV 6" COILOVER KIT

COMPONENTS INCLUDED	
(1) 154872CD 22-UP TUNDRA 6" CO RR CDCV UPKG DRVR	(1) 154872CP 22-UP TUNDRA 6" CO RR CDCV UPKG PASS
HARDWARE INCLUDED	
(1) 150126 22-UP TUNDRA FRONT RESI MOUNT DRVR (1) 150127 22-UP TUNDRA FRONT RESI MOUNT PASS	(4) 605144 3/8-12 X .750 FLANGED SELF TAP BOLT CZINC (1) 611025 07-22 TUNDRA CO HARDWARE KIT (1) 611051 #36 1.188-2.750 STAINLESS HOSE CLAMP KIT (4)
TOOLS REQUIRED	
JACK JACK STANDS HAMMER BALLJOINT SEPARATOR FLAT BLADE SCREWDRIVER PLIERS TORQUE WRENCH RATCHET	14MM SOCKET / WRENCH 19MM SOCKET / WRENCH 22MM SOCKET / WRENCH 9/16" SOCKET / WRENCH 5/16" NUT DRIVER
TECH NOTES	
<p>1. YOUR ICON COILOVER ASSEMBLIES COME FACTORY CHARGED TO 150 PSI. RELEASING NITROGEN PRESSURE MAY LEAD TO SHOCK MALFUNCTION AND REDUCED RIDE QUALITY. FAILURE CAUSED BY LOW NITROGEN PRESSURE IS NOT COVERED UNDER ICON'S WARRANTY POLICY.</p> <p>2. YOUR ICON COILOVER ASSEMBLIES COME SHIPPED AT ICON'S RECOMMENDED RIDE HEIGHT. REDUCING DROOP TRAVEL WILL REDUCE RIDE QUALITY. DO NOT PRELOAD THE COIL BEYOND 1.165" OF EXPOSED THREADS BETWEEN THE BOTTOM OF THE TOP CAP AND THE TOP OF THE COIL ADJUSTER NUT. ADJUSTING PRELOAD BEYOND THIS SETTING WILL CAUSE THE COIL TO BIND AND DAMAGE WILL OCCUR TO COILOVER AND/OR VEHICLE.</p> <p>3. INSTALL TIME: 1-2 HOURS</p>	



WARNING!
<p>** READ ALL INSTRUCTIONS THOROUGHLY FROM START TO FINISH BEFORE BEGINNING INSTALLATION! IF THESE INSTRUCTIONS ARE NOT PROPERLY FOLLOWED SEVERE FRAME, SUSPENSION AND TIRE DAMAGE MAY RESULT TO THE VEHICLE!</p> <p>** ICON VEHICLE DYNAMICS RECOMMENDS THAT YOU EXERCISE EXTREME CAUTION WHEN WORKING UNDER A VEHICLE THAT IS SUPPORTED WITH JACK STANDS.</p> <p>** ICON VEHICLE DYNAMICS RECOMMENDS ALL INSTALLATION TO BE PERFORMED BY A PROFESSIONAL SHOP/SERVICE TECHNICIAN. PRODUCT FAILURE CAUSED BY IMPROPER INSTALLATION WILL NOT BE COVERED UNDER ICON'S WARRANTY POLICY.</p>

INSTALLATION

1. These instructions are in conjunction with (51010) 6" kit instructions.
2. You will need to mark and grind/cut the lower coilover mount on the lower control arm as pictured. If this is not done, damage to the coilover and/or truck is possible. [FIGURE 1 & 2]

FIG.1



FIG.2



3. Once the cuts are finished, paint the exposed metal to prevent rust/corrosion.
4. Reinstall control arm into the icon drop brackets using OEM hardware.
5. Install the new ICON coilover, lower eyelet first with the spacers, then the upper mount. Torque the upper bolts to 35 ft-lbs, and the lower bolt to 130 ft-lbs. Apply thread locker to all bolts. [FIGURE 3 & 4]

FIG.3



FIG.4



6. Remove the front rubber splash guard using a needle nose pliers to pinch and pull the clips out. 3 on driver side and 4 on passenger side. [FIGURE 5]

FIG.5



7. With the splash guard removed. Locate the reservoir bracket in the box along with 2 self threading 3/8 x 1" screws. Attach the bracket using the screws into the 2 frame holes that the splash guard used. The brackets have a slight bend in them that faces out to clear the fender well. Use the supplied hose clamps to secure the reservoir to the bracket. [FIGURE 6 & 7]

FIG.6



FIG.7



8. Refer back to the (51010 instructions) now.

VERIFY ALL FASTENERS ARE PROPERLY TORQUED BEFORE DRIVING VEHICLE.

RETORQUE ALL NUTS, BOLTS AND LUGS AFTER 100 MILES AND PERIODICALLY THEREAFTER.

2.5 VS SERIES SHOCK & COILOVER TECHNICAL INFORMATION

MAINTENANCE

ICON shock absorbers are a high quality rebuildable race style shock absorber designed for optimal performance. With a unit of this caliber on your vehicle, routine maintenance is required to keep them looking and operating in like new condition. Residual oil and assembly lube may be present at all seal paths from the factory out of the box and is considered normal. Pooling of oil however is not acceptable at any time and one should contact the ICON dealer where purchased.

BELOW ARE GUIDELINES BASED ON HOW YOU USE YOUR VEHICLE BUT YOUR MILEAGE MAY VARY:

STREET USE:

- Send in for factory servicing every 40,000 miles or if a leak develops, ride quality decreases, or they begin to make excessive noise.
- Remove any buildup of road salt, mud, or debris from shocks and coil springs anytime accrued
- Clean with mild soap and water with each oil change or anytime you notice build up.
- Wax the cylinders yearly with automotive wax to prevent corrosion.
- Check nitrogen pressure yearly. (252004 charge needle assembly available at any ICON distributor)
- Check bearings for excessive wear yearly.
- DO NOT apply any type of lube to the upper and lower bearings.

STREET/DIRT:

- Send in for factory servicing every 15,000 miles or if a leak develops, ride quality decreases, or they begin to make excessive noise.
- Clean with mild soap and water with each oil change, offroad trip, or anytime you notice build up.
- Wax the cylinders yearly with automotive wax to prevent corrosion.
- Check nitrogen pressure each dirt outing. (252004 charge needle assembly available at any ICON distributor)
- Check bearings for excessive wear yearly.
- DO NOT apply any type of lube to the upper and lower bearings.

DIRT USE:

- Send in for factory servicing every 1,000 miles.
- Check nitrogen pressure each outing. (252004 charge needle assembly available at any ICON distributor)
- Remove any buildup of mud or debris from shocks and coil springs after every outing.

SELF-SERVICE:

- Contact ICON for service kits & tools at (951) 689-4266.

PRODUCT REGISTRATION

Please visit: <http://www.iconvehicledynamics.com/tech-support/registration/> to register your product.

ICON VEHICLE DYNAMICS SHOCK ABSORBER WARRANTY

This shock absorber has a 1 year warranty against any manufacturer's defects. If a shock fails within the initial year of ownership, the shock must be shipped to ICON Vehicle Dynamics for inspection and service. If a shock is inspected and it has been determined the shock failed due to neglect, damage caused by improper installation or any other reason besides "normal wear and tear", the owner of said shock is responsible for all service costs. This includes labor, parts, and shipping.

ICON Vehicle Dynamics warrants to the original retail purchaser who owns the vehicle on which the product was originally installed. ICON Vehicle Dynamics does not warrant the product for finish, alterations, modifications and/or installation contrary to ICON Vehicle Dynamics instructions. ICON Vehicle Dynamics products are not designed, nor are they intended to be installed on vehicles used in race applications, for racing purposes or for similar activities. (A "race" is defined as any contest between two or more vehicles, or a contest of one or more vehicles against the clock, whether or not such contest is for a prize). This warranty does not include coverage for police or taxi vehicles, race vehicles, or vehicles used for government or commercial purposes. Also excluded from this warranty are sales outside of the United States of America and Canada.

ICON Vehicle Dynamics' obligation under this warranty is limited to the repair or replacement, at ICON Vehicle Dynamics' discretion, of the defective product. Any and all costs of removal, installation or re-installation, freight charges and incidental or consequential damages are expressly excluded from this warranty. Items that are subject to wear are not considered defective when worn and are not covered.

ICON Vehicle Dynamics components must be installed as a complete kit as shown in our current application guide. Any substitutions or exemptions of required components will immediately void the warranty. Some finish damage may happen to parts during shipping and is not covered under warranty.

This warranty is expressly in lieu of all other warranties expressed or implied. This warranty shall not apply to any product that has been improperly installed, modified or customized subject to accident, negligence, abuse or misuse.

To send a shock in for warranty please visit our website <http://www.iconvehicledynamics.com/tech-support/shock-service/>



ICON VEHICLE DYNAMICS®
PERFORMANCE SUSPENSION SYSTEMS AND SHOCK ABSORBERS

7929 Lincoln Ave. Riverside, CA 92504 Phone: 951.689.ICON Fax: 951.689.1016
www.iconvehicledynamics.com



FOLLOW US ON FACEBOOK!

