

7929 Lincoln Ave. Riverside, CA 92504
Phone: 951.689.ICON | Fax: 951.689.1016

PART #	DESCRIPTION
51213	24 TACOMA .75" LIFT TRIPLE RATE REAR COIL SPRING KIT

COMPONENTS INCLUDED	
(2) 158573 24 TACOMA .75" LIFT TRIPLE RATE COIL SPRING	
HARDWARE INCLUDED	
N/A	
TOOLS REQUIRED	
JACK JACK STANDS TORQUE WRENCH RATCHETS	12MM SOCKET/WRENCH 17MM SOCKET / WRENCH COIL SPRING COMPRESSOR
TECH NOTES	
1. ESTIMATED INSTALL TIME: 2 HOURS.	



WARNING!
** READ ALL INSTRUCTIONS THOROUGHLY FROM START TO FINISH BEFORE BEGINNING INSTALLATION! IF THESE INSTRUCTIONS ARE NOT PROPERLY FOLLOWED SEVERE FRAME, SUSPENSION AND TIRE DAMAGE MAY RESULT TO THE VEHICLE!
** ICON VEHICLE DYNAMICS RECOMMENDS THAT YOU EXERCISE EXTREME CAUTION WHEN WORKING UNDER A VEHICLE THAT IS SUPPORTED WITH JACK STANDS.
** ICON VEHICLE DYNAMICS RECOMMENDS ALL INSTALLATION TO BE PERFORMED BY A PROFESSIONAL SHOP/SERVICE TECHNICIAN. PRODUCT FAILURE CAUSED BY IMPROPER INSTALLATION WILL NOT BE COVERED UNDER ICON'S WARRANTY POLICY.

INSTALLATION

Place vehicle in park on a level surface. Engage parking brake. Block the front tires. Lift rear of vehicle and place jack stands under the manufacturer recommended locations. NEVER WORK UNDER AN UNSUPPORTED VEHICLE.

OPTION 1: No spring compressor available.

1. Place a jack under the center of the axle so it can be lowered to assist in spring removal.
2. Using a 12mm, remove the brake line, E-brake line, speed sensor and E-locker wiring brackets.
3. Remove the lower shock eyelet using a 17mm and pull the shock off the mounting stud. [FIGURE 1]

FIG.1



4. Slowly lower the axle down until the springs become loose, being careful not to overextend any brake lines or wiring harness.
5. Lift the spring and pull it out from the bottom, rotating it can help to clear the mount on the axle housing spring perch.
6. Remove the bump stop cone from the factory spring and install it into the new ICON spring, then install it into the truck. Being sure the lower spring seat is in the spring perch correctly. Repeat on passenger side.
7. Reinstall shocks and brake lines.

OPTION 2: Use a spring compressor.

1. Use a spring compressor like the one shown. [FIGURE 2]

FIG.2



2. Leave all brackets attached. Remove the lower shock mount with a 17mm and lower the axle, being sure not to overextend any brake lines or wiring harness.

3. Install spring compressor with appropriate spring attachment and tighten to compress the spring until it can be removed. [FIGURE 3]

FIG.3



4. Remove the spring compressor from the factory spring and install it onto the new ICON spring.

5. Remove the bump stop cone from the factory spring and install it into the new ICON spring. Compress the spring enough so that it can be installed into the truck, making sure the spring seats into the upper and lower spring perch correctly. Repeat on passenger side.

6. Reinstall wheels and tires, enjoy your new springs and ride.

VERIFY ALL FASTENERS ARE PROPERLY TORQUED BEFORE DRIVING VEHICLE.

RETORQUE ALL NUTS, BOLTS AND LUGS AFTER 100 MILES AND PERIODICALLY THEREAFTER.

ICON VEHICLE DYNAMICS LIMITED LIFETIME WARRANTY

ICON Vehicle Dynamics warrants to the original retail purchaser who owns the vehicle on which the product was originally installed. ICON Vehicle Dynamics does not warrant the product for finish, alterations, modifications and/or installation contrary to ICON Vehicle Dynamics instructions. ICON Vehicle Dynamics products are not designed, nor are they intended to be installed on vehicles used in race applications, for racing purposes or for similar activities. (A "race" is defined as any contest between two or more vehicles, or a contest of one or more vehicles against the clock, whether or not such contest is for a prize). This warranty does not include coverage for police or taxi vehicles, race vehicles, or vehicles used for government or commercial purposes. Also excluded from this warranty are sales outside of the United States of America and Canada.

ICON Vehicle Dynamics' obligation under this warranty is limited to the repair or replacement, at ICON Vehicle Dynamics' discretion, of the defective product. Any and all costs of removal, installation or re-installation, freight charges and incidental or consequential damages are expressly excluded from this warranty. Items that are subject to wear are not considered defective when worn and are not covered.

ICON Vehicle Dynamics components must be installed as a complete kit as shown in our current application guide. Any substitutions or exemptions of required components will immediately void the warranty. Some finish damage may happen to parts during shipping and is not covered under warranty.

This warranty is expressly in lieu of all other warranties expressed or implied. This warranty shall not apply to any product that has been improperly installed, modified or customized subject to accident, negligence, abuse or misuse.



ICON VEHICLE DYNAMICS®
PERFORMANCE SUSPENSION SYSTEMS AND SHOCK ABSORBERS

7929 Lincoln Ave. Riverside, CA 92504 Phone: 951.689.ICON Fax: 951.689.1016
www.iconvehicledynamics.com



FOLLOW US ON FACEBOOK!



7929 Lincoln Ave. Riverside, CA 92504
 Phone: 951.689.ICON | Fax: 951.689.1016

PART #	DESCRIPTION
53509	24 TACOMA IIC KIT

COMPONENTS INCLUDED	
(1) 150146 24 TACOMA IIC MOUNT (1) 255600 IIC CONTROLLER (1) 255601 BLOCK OFF PLUG	(1) 255602 WIRE HARNESS (2) 255607 FUSE TAP LOW PROFILE MINI
HARDWARE INCLUDED	
(2) 605052 1/4-20 BYLOCK NUT (2) 605069 1/4-20 X 1.25 BOLT (2) 605750 BUTT CONNECTOR (3) 605751 5/16 TERMINAL CONNECTOR (1) 605753 LOW PROFILE MINI FUSE 2 AMP (1) 605760 WIRE LOOM 1/4" X 6FT	(1) 605926-BLK-100 BLACK NYLON CABLE TIE 100PK (2) 605984 RUBBER STRIP 1" X 3" ADHESIVE BACK (1) 605758 LOW PROFILE MINI FUSE 10 AMP
WIRES INCLUDED WITH FRONT SHOCKS	
PASS FRONT: (1) 255604-04 4-FT WIRE	DRIVER FRONT: (1) 255604-14 14-FT WIRE
WIRES INCLUDED WITH REAR SHOCKS	
PASS REAR: (1) 255604-16 16-FT WIRE	DRIVER REAR: (1) 255604-20 20-FT WIRE
TOOLS REQUIRED	
WIRE CUTTERS WIRE STRIPPER WIRE CRIMPERS FLUSH CUTS PHILLIPS HEAD SCREWDRIVER	HEAT GUN TORQUE WRENCH 10MM SOCKET / WRENCH 7/16" SOCKET / WRENCH
TECH NOTES	
<ol style="list-style-type: none"> 1. WIRE LENGTHS ARE MEASURED FOR 4CYL, CREW CAB, SHORT BED. 2. GOLD WIRE COLOR IN FIGURES DENOTES BASIC WIRE PATH (FOR CLARITY). 3. SEE PAGE 6 FOR WIRE ROUTING DIAGRAM. 	
FUSE OPTIONS	
S/HTR F/L (15A)	

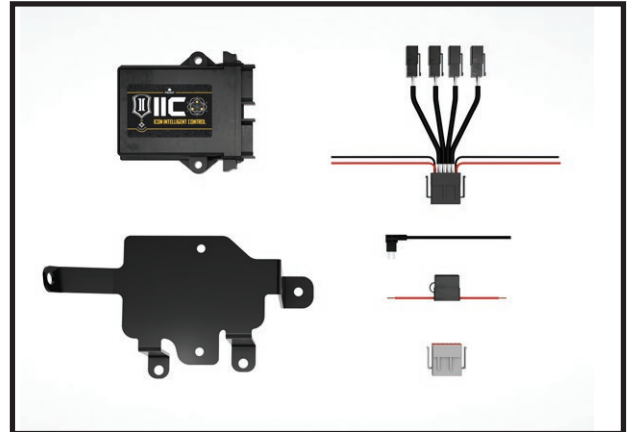

WARNING!

**** READ ALL INSTRUCTIONS THOROUGHLY FROM START TO FINISH BEFORE BEGINNING INSTALLATION! IF THESE INSTRUCTIONS ARE NOT PROPERLY FOLLOWED SEVERE FRAME, SUSPENSION AND TIRE DAMAGE MAY RESULT TO THE VEHICLE!**

**** ICON VEHICLE DYNAMICS RECOMMENDS THAT YOU EXERCISE EXTREME CAUTION WHEN WORKING UNDER A VEHICLE THAT IS SUPPORTED WITH JACK STANDS.**

**** ICON VEHICLE DYNAMICS RECOMMENDS ALL INSTALLATION TO BE PERFORMED BY A PROFESSIONAL SHOP/SERVICE TECHNICIAN. PRODUCT FAILURE CAUSED BY IMPROPER INSTALLATION WILL NOT BE COVERED UNDER ICON'S WARRANTY POLICY.**

INSTALLATION

1. Disconnect the Battery using a 10mm.
2. Taking the IIC mount (PN 150146) apply the adhesive strips (PN 605984) between the bolt holes.
3. Using the supplies 1/4-20 bolt and nuts mount the IIC controller to the mount. [FIGURE 1]



FIG.1

4. Locate the open space on the driver side in front of the fuse box . [FIGURE 2]



FIG.2

5. Using a 10mm socket remove the bolts and place the IIC mount (PN 150146) as shown. install the all the bolts except the one marked. [FIGURE 3]

FIG.4



6. Plug in the grey block off plug (PN 255601) to the grey port. Plug in the main wire harness (PN 255602) to the black port as shown. [FIGURE 4]

FIG.4



7. Route the 2 black ground wires to the ground connection under the IIC mount on the fender. Cut to length, strip and crimp the terminal connectors (PN 605751) on. Use a heat gun to activate heat shrink. Connect to the fender ground using a 10mm tighten all IIC mounting bolts at this time. [FIGURE 5]

FIG.5



8. Route the red ACC (ACCESSORY) wire and main power wire down to the wire loom at the base of the fuse box. Feed the red AAC (ACCESSORY) wire and main power wire up into the fuse box. [FIGURE 7]

FIG.7



9. Locate the supplied fuse tap (PN 255607) and low-profile mini fuse. using the main power this time tap Insert the supplied 10 AMP fuse into the upper fuse slot on the fuse tap. Locate the 10A INJ fuse. Remove the 10 AMP INJ fuse and insert it into the lower slot on the fuse tap.
10. Insert the fuse tap in the original location of the INJ fuse.
11. Locate the supplied fuse tap (PN 255607) and low-profile mini fuse. starting with the accessory tap Insert the supplied 2 AMP fuse into the upper fuse slot on the fuse tap. Locate the 10A AUX NO.2 fuse. Remove the 10 AMP AUX NO.2 fuse and insert it into the lower slot on the fuse tap. [FIGURE 8, 8a]
12. Insert the fuse tap in the original location of the AUX NO.2 fuse.
13. Use the supplied butt connector (PN 605750) to connect the fuse tap to the red ACC (ACCESSORY) wire. Then use the other supplied butt connector to connect the 10 AMP fuse tap to the main power wire. Use a heat gun to activate heat shrink. [FIGURE 8, 8b]

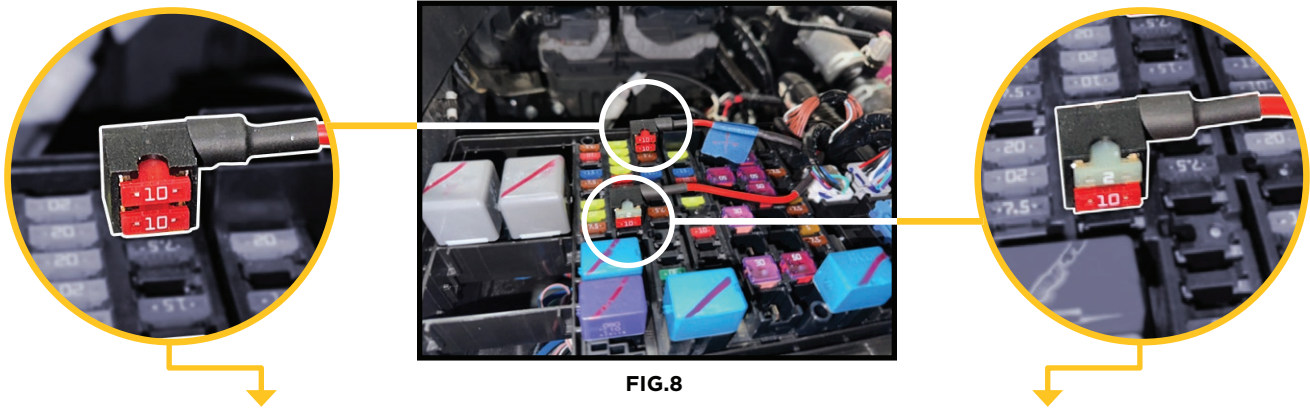

FIG.8

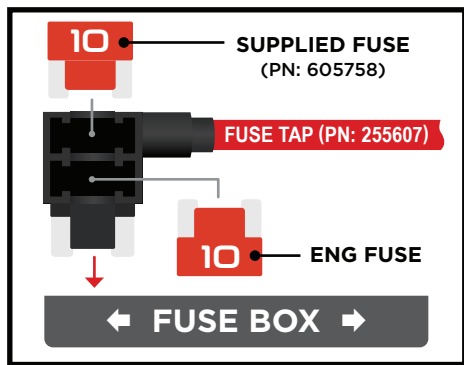

FIG.8a

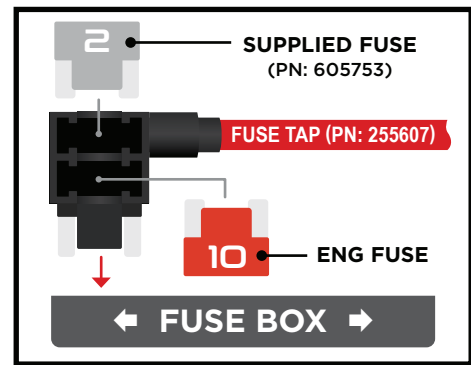
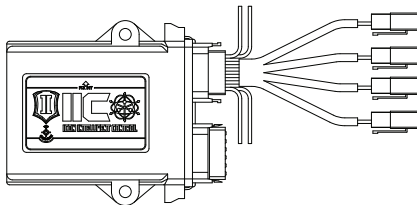

FIG.8b

WIRE CONNECTIONS



PLUG	POSITION	WIRE LENGTH	PART #
4	DRIVER FRONT	4-FT WIRE	255064-04
3	PASSENGER FRONT	14-FT WIRE	255064-14
2	DRIVER REAR	16-FT WIRE	255064-16
1	PASSENGER REAR	20-FT WIRE	255064-20

14. Route the 4-ft wire down to the frame rail to the driver side front shock. [FIGURE 9]

FIG.9



15. Route the 14-ft wire back to the fire wall and across the to the passenger side. Route the wire under the battery along the frame rail to the passenger side front shock. [FIGURE 10, 11, 12]

FIG.10

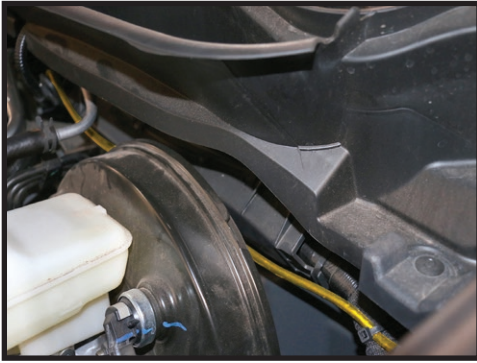

FIG.11

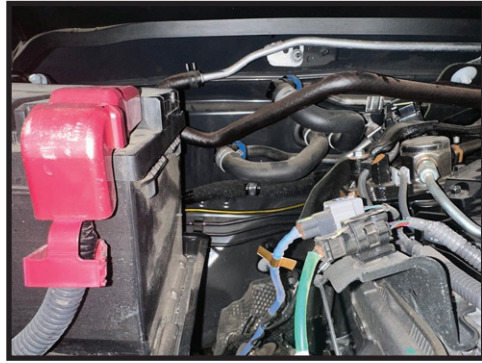

FIG.12



16. Route the 16-ft and 20-ft wires down along the frame.

17. Route the wires along the brake lines down to the frame rail. using the zip-ties to hold the wires to the brake line [FIGURE 13 & 14]

FIG.13

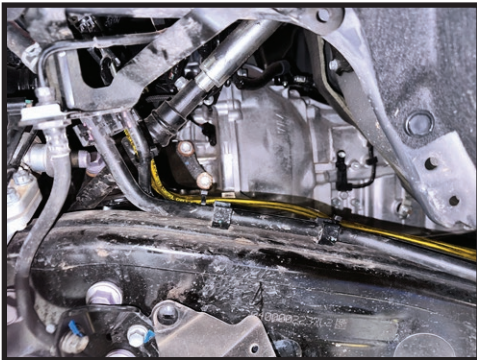

FIG.14



18. Route the wires along the wire harness to the driver rear shock. Route the 16-ft wire to the driver side rear shock reservoir. [FIGURE 15 & 16]

FIG.15



FIG.16



19. Route the 20-ft wire across the crossmember following the wire harness to the driver side rear shock. Continue to the passenger side rear shock reservoir. [FIGURE 17 & 18]



FIG.17



FIG.18

20. Reconnect the battery using a 10mm.

21. Download the ICON INTELLIGENT CONTROL App on your device. Open the app and turn on the vehicle.

VERIFY ALL FASTENERS ARE PROPERLY TORQUED BEFORE DRIVING VEHICLE.

RETORQUE ALL NUTS, BOLTS AND LUGS AFTER 100 MILES AND PERIODICALLY THEREAFTER.

ICON VEHICLE DYNAMICS LIMITED LIFETIME WARRANTY

ICON Vehicle Dynamics warrants to the original retail purchaser who owns the vehicle on which the product was originally installed. ICON Vehicle Dynamics does not warrant the product for finish, alterations, modifications and/or installation contrary to ICON Vehicle Dynamics instructions. ICON Vehicle Dynamics products are not designed, nor are they intended to be installed on vehicles used in race applications, for racing purposes or for similar activities. (A "race" is defined as any contest between two or more vehicles, or a contest of one or more vehicles against the clock, whether or not such contest is for a prize). This warranty does not include coverage for police or taxi vehicles, race vehicles, or vehicles used for government or commercial purposes. Also excluded from this warranty are sales outside of the United States of America and Canada.

ICON Vehicle Dynamics' obligation under this warranty is limited to the repair or replacement, at ICON Vehicle Dynamics' discretion, of the defective product. Any and all costs of removal, installation or re-installation, freight charges and incidental or consequential damages are expressly excluded from this warranty. Items that are subject to wear are not considered defective when worn and are not covered.

ICON Vehicle Dynamics components must be installed as a complete kit as shown in our current application guide. Any substitutions or exemptions of required components will immediately void the warranty. Some finish damage may happen to parts during shipping and is not covered under warranty.

This warranty is expressly in lieu of all other warranties expressed or implied. This warranty shall not apply to any product that has been improperly installed, modified or customized subject to accident, negligence, abuse or misuse.



ICON VEHICLE DYNAMICS®
PERFORMANCE SUSPENSION SYSTEMS AND SHOCK ABSORBERS

7929 Lincoln Ave. Riverside, CA 92504 Phone: 951.689.ICON Fax: 951.689.1016
www.iconvehicledynamics.com



FOLLOW US ON FACEBOOK!



WIRE ROUTING DIAGRAM: 2024 Tacoma

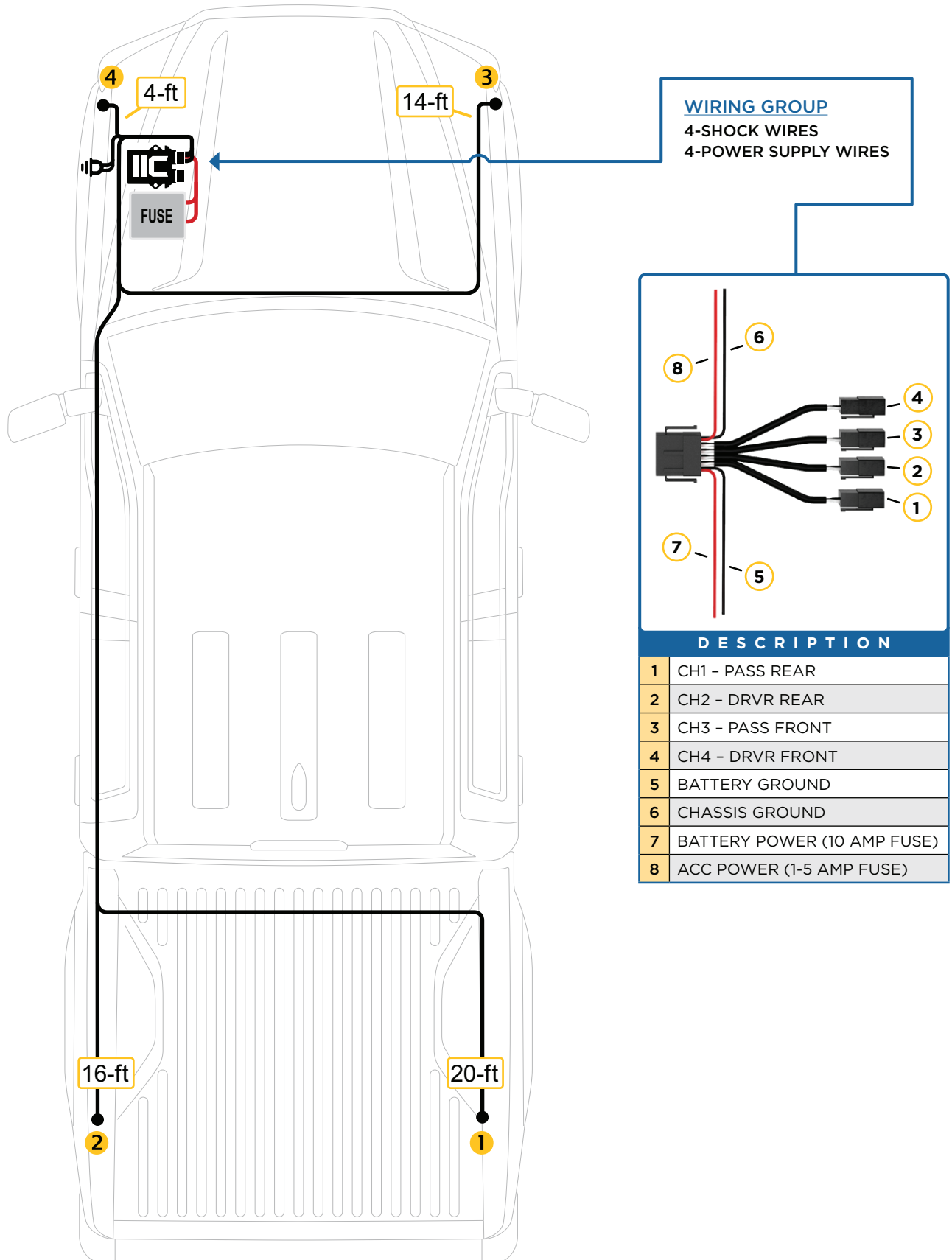

7929 Lincoln Ave. Riverside, CA 92504
 Phone: 951.689.ICON | Fax: 951.689.1016

PART #	DESCRIPTION
53509	24 TACOMA / 24 LC250 IIC KIT

COMPONENTS INCLUDED	
(1) 150146 24 TACOMA IIC MOUNT (1) 255600 IIC CONTROLLER (1) 255601 BLOCK OFF PLUG	(1) 255602 WIRE HARNESS (2) 255607 FUSE TAP LOW PROFILE MINI
HARDWARE INCLUDED	
(2) 605052 1/4-20 BYLOCK NUT (2) 605069 1/4-20 X 1.25 BOLT (2) 605750 BUTT CONNECTOR (3) 605751 5/16 TERMINAL CONNECTOR (1) 605753 LOW PROFILE MINI FUSE 2 AMP (1) 605760 WIRE LOOM 1/4" X 6FT	(1) 605926-BLK-100 BLACK NYLON CABLE TIE 100PK (2) 605984 RUBBER STRIP 1" X 3" ADHESIVE BACK (1) 605758 LOW PROFILE MINI FUSE 10 AMP
WIRES INCLUDED WITH FRONT SHOCKS	
PASS FRONT: (1) 255604-04 4-FT WIRE	DRIVER FRONT: (1) 255604-14 14-FT WIRE
WIRES INCLUDED WITH REAR SHOCKS	
PASS REAR: (1) 255604-16 16-FT WIRE	DRIVER REAR: (1) 255604-20 20-FT WIRE
TOOLS REQUIRED	
WIRE CUTTERS WIRE STRIPPER WIRE CRIMPERS FLUSH CUTS PHILLIPS HEAD SCREWDRIVER	HEAT GUN TORQUE WRENCH 10MM SOCKET / WRENCH 7/16" SOCKET / WRENCH
TECH NOTES	
1. WIRE LENGTHS ARE MEASURED FOR 4CYL, CREW CAB, SHORT BED. 2. GOLD WIRE COLOR IN FIGURES DENOTES BASIC WIRE PATH (FOR CLARITY). 3. SEE PAGE 6 FOR WIRE ROUTING DIAGRAM.	
FUSE OPTIONS	
S/HTR F/L (15A)	

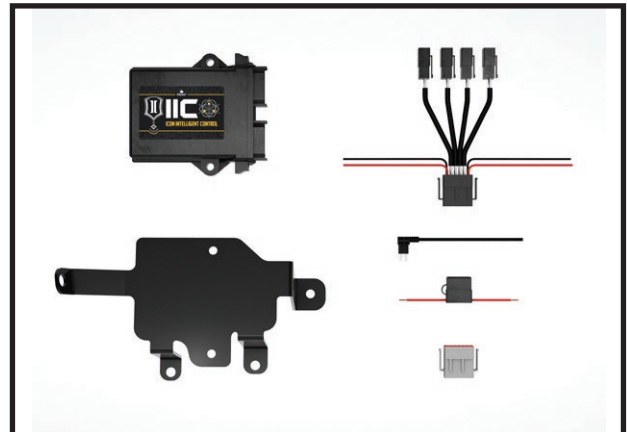

WARNING!

**** READ ALL INSTRUCTIONS THOROUGHLY FROM START TO FINISH BEFORE BEGINNING INSTALLATION! IF THESE INSTRUCTIONS ARE NOT PROPERLY FOLLOWED SEVERE FRAME, SUSPENSION AND TIRE DAMAGE MAY RESULT TO THE VEHICLE!**

**** ICON VEHICLE DYNAMICS RECOMMENDS THAT YOU EXERCISE EXTREME CAUTION WHEN WORKING UNDER A VEHICLE THAT IS SUPPORTED WITH JACK STANDS.**

**** ICON VEHICLE DYNAMICS RECOMMENDS ALL INSTALLATION TO BE PERFORMED BY A PROFESSIONAL SHOP/SERVICE TECHNICIAN. PRODUCT FAILURE CAUSED BY IMPROPER INSTALLATION WILL NOT BE COVERED UNDER ICON'S WARRANTY POLICY.**

INSTALLATION

1. Disconnect the Battery using a 10mm.
2. Taking the IIC mount (PN 150146) apply the adhesive strips (PN 605984) between the bolt holes.
3. Using the supplies 1/4-20 bolt and nuts mount the IIC controller to the mount. [FIGURE 1]



FIG.1

4. Locate the open space on the driver side in front of the fuse box . [FIGURE 2]



FIG.2

5. Using a 10mm socket remove the bolts and place the IIC mount (PN 150146) as shown. Install the all the bolts except the one marked. [FIGURE 3]

FIG.3



6. Plug in the grey block off plug (PN 255601) to the grey port. Plug in the main wire harness (PN 255602) to the black port as shown. [FIGURE 4]

FIG.4



7. Route the 2 black ground wires to the ground connection under the IIC mount on the fender. Cut to length, strip and crimp the terminal connectors (PN 605751) on. Use a heat gun to activate heat shrink. Connect to the fender ground using a 10mm tighten all IIC mounting bolts at this time. [FIGURE 5]

FIG.5



8. Route the red ACC (ACCESSORY) wire and main power wire down to the wire loom at the base of the fuse box. Feed the red AAC (ACCESSORY) wire and main power wire up into the fuse box. [FIGURE 6]

FIG.6



TACOMA INSTALLATION (if installing on a Land Cruiser 250, skip to step 14)

9. Locate the supplied fuse tap (PN 255607) and low-profile mini fuse. Using the main power this time tap Insert the supplied 10 AMP fuse into the upper fuse slot on the fuse tap. Locate the 10A INJ fuse. Remove the 10 AMP INJ fuse and insert it into the lower slot on the fuse tap.
10. Insert the fuse tap in the original location of the INJ fuse.
11. Locate the supplied fuse tap (PN 255607) and low-profile mini fuse. Starting with the accessory tap Insert the supplied 2 AMP fuse into the upper fuse slot on the fuse tap. Locate the 10A AUX NO.2 fuse. Remove the 10 AMP AUX NO.2 fuse and insert it into the lower slot on the fuse tap. [FIGURE 7, 7a]
12. Insert the fuse tap in the original location of the AUX NO.2 fuse.
13. Use the supplied butt connector (PN 605750) to connect the fuse tap to the red ACC (ACCESSORY) wire. Then use the other supplied butt connector to connect the 10 AMP fuse tap to the main power wire. Use a heat gun to activate heat shrink. [FIGURE 7, 7b]

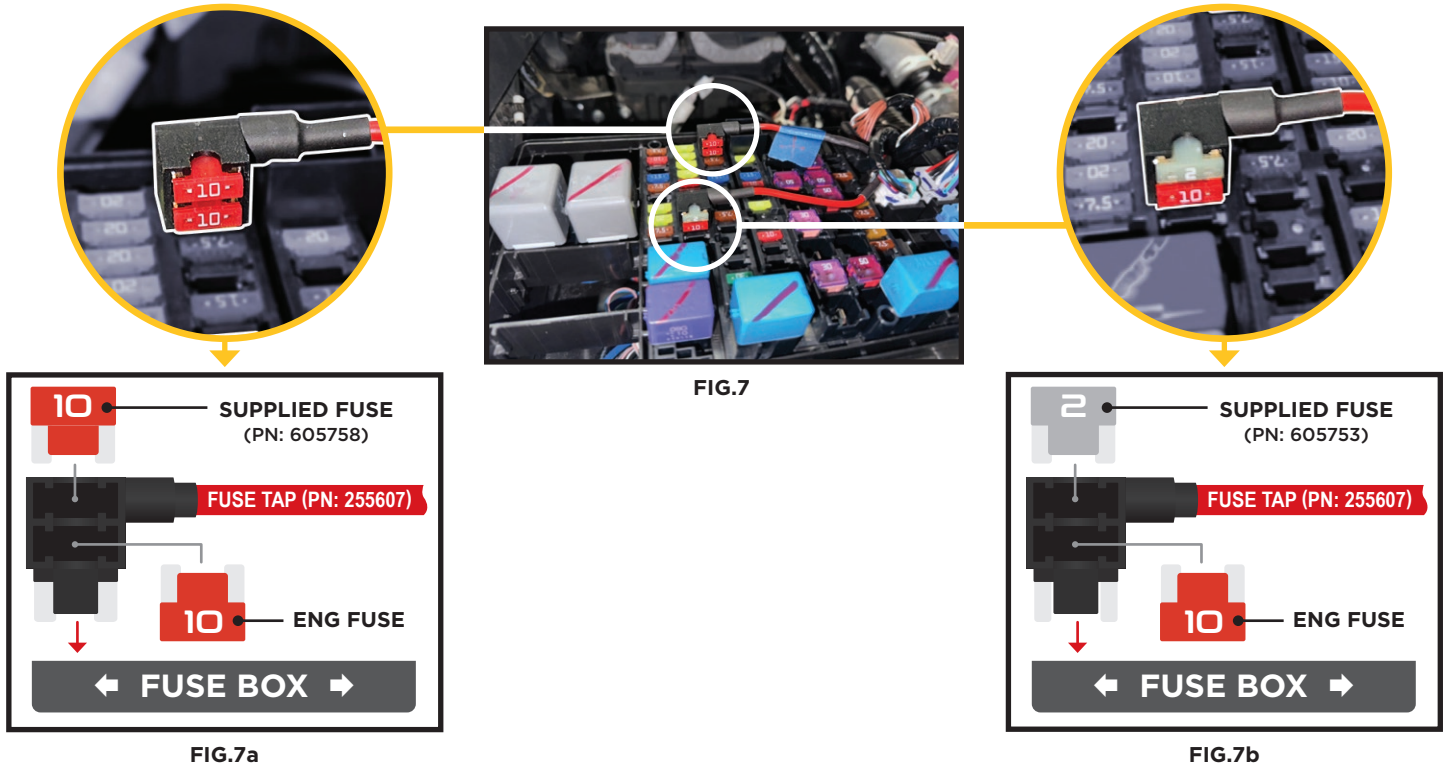

LAND CRUISER 250 INSTALLATION

14. Locate the supplied fuse tap (PN 255607) and low-profile mini fuse. Using the main power this time tap Insert the supplied 10 AMP fuse into the upper fuse slot on the fuse tap. Locate the 7.5A EFI NO.2 fuse. Remove the 17.5A EFI NO.2 fuse and insert it into the lower slot on the fuse tap.
15. Insert the fuse tap in the original location of the EFI NO.2 fuse slot.
16. Locate the supplied fuse tap (PN 255607) and low-profile mini fuse. Starting with the accessory tap Insert the supplied 2 AMP fuse into the upper fuse slot on the fuse tap. Locate the 7.5A ENG-IGR NO.2 fuse. Remove the 7.5A ENG-IGR NO.2 fuse and insert it into the lower slot on the fuse tap. [FIGURE 8, 8a]
17. Insert the fuse tap in the original location of the ENG-IGR NO.2 fuse slot.
18. Use the supplied butt connector (PN 605750) to connect the fuse tap to the red ACC (ACCESSORY) wire. Then use the other supplied butt connector to connect the 10 AMP fuse tap to the main power wire. Use a heat gun to activate heat shrink. [FIGURE 8, 8b]

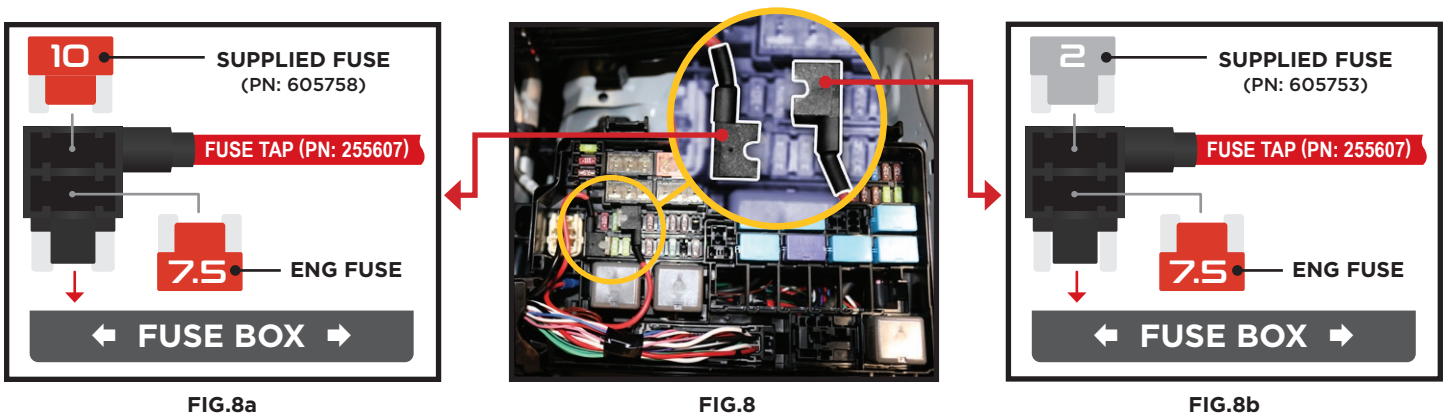

WIRE CONNECTIONS

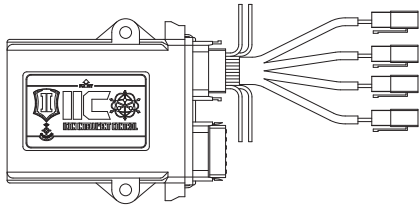

PLUG	POSITION	WIRE LENGTH	PART #
4	DRIVER FRONT	4-FT WIRE	255064-04
3	PASSENGER FRONT	14-FT WIRE	255064-14
2	DRIVER REAR	16-FT WIRE	255064-16
1	PASSENGER REAR	20-FT WIRE	255064-20

19. Route the 4-ft wire down to the frame rail to the driver side front shock. [FIGURE 9]

FIG.9



20. Route the 14-ft wire back to the fire wall and across the to the passenger side. Route the wire under the battery along the frame rail to the passenger side front shock. [FIGURE 10, 11, 12]

FIG.10

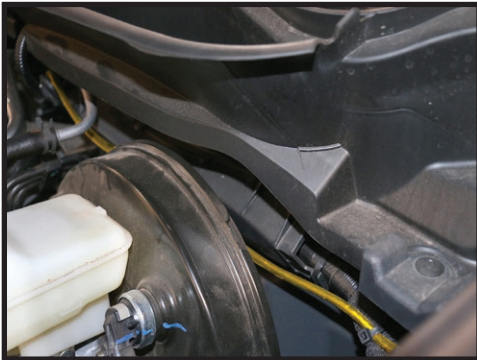

FIG.11



FIG.12



21. Route the 16-ft and 20-ft wires down along the frame.

22. Route the wires along the brake lines down to the frame rail. Using the zip-ties to hold the wires to the brake line [FIGURE 13 & 14]

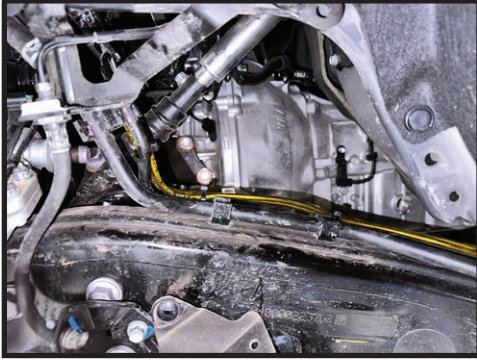

FIG.13



FIG.14

23. Route the wires along the wire harness to the driver rear shock. Route the 16-ft wire to the driver side rear shock reservoir. [FIGURE 15 & 16]



FIG.15



FIG.16

24. Route the 20-ft wire across the crossmember following the wire harness to the driver side rear shock. Continue to the passenger side rear shock reservoir. [FIGURE 17 & 18]



FIG.17



FIG.18

25. Reconnect the battery using a 10mm.

26. Download the ICON INTELLIGENT CONTROL App on your device. Open the app and turn on the vehicle.

VERIFY ALL FASTENERS ARE PROPERLY TORQUED BEFORE DRIVING VEHICLE.

RETORQUE ALL NUTS, BOLTS AND LUGS AFTER 100 MILES AND PERIODICALLY THEREAFTER.

ICON VEHICLE DYNAMICS LIMITED LIFETIME WARRANTY

ICON Vehicle Dynamics warrants to the original retail purchaser who owns the vehicle on which the product was originally installed. ICON Vehicle Dynamics does not warrant the product for finish, alterations, modifications and/or installation contrary to ICON Vehicle Dynamics instructions. ICON Vehicle Dynamics products are not designed, nor are they intended to be installed on vehicles used in race applications, for racing purposes or for similar activities. (A "race" is defined as any contest between two or more vehicles, or a contest of one or more vehicles against the clock, whether or not such contest is for a prize). This warranty does not include coverage for police or taxi vehicles, race vehicles, or vehicles used for government or commercial purposes. Also excluded from this warranty are sales outside of the United States of America and Canada.

ICON Vehicle Dynamics' obligation under this warranty is limited to the repair or replacement, at ICON Vehicle Dynamics' discretion, of the defective product. Any and all costs of removal, installation or re-installation, freight charges and incidental or consequential damages are expressly excluded from this warranty. Items that are subject to wear are not considered defective when worn and are not covered.

ICON Vehicle Dynamics components must be installed as a complete kit as shown in our current application guide. Any substitutions or exemptions of required components will immediately void the warranty. Some finish damage may happen to parts during shipping and is not covered under warranty.

This warranty is expressly in lieu of all other warranties expressed or implied. This warranty shall not apply to any product that has been improperly installed, modified or customized subject to accident, negligence, abuse or misuse.



ICON VEHICLE DYNAMICS®
PERFORMANCE SUSPENSION SYSTEMS AND SHOCK ABSORBERS

7929 Lincoln Ave. Riverside, CA 92504 Phone: 951.689.ICON Fax: 951.689.1016
www.iconvehicledynamics.com



FOLLOW US ON FACEBOOK!



WIRE ROUTING DIAGRAM: 2024 Tacoma

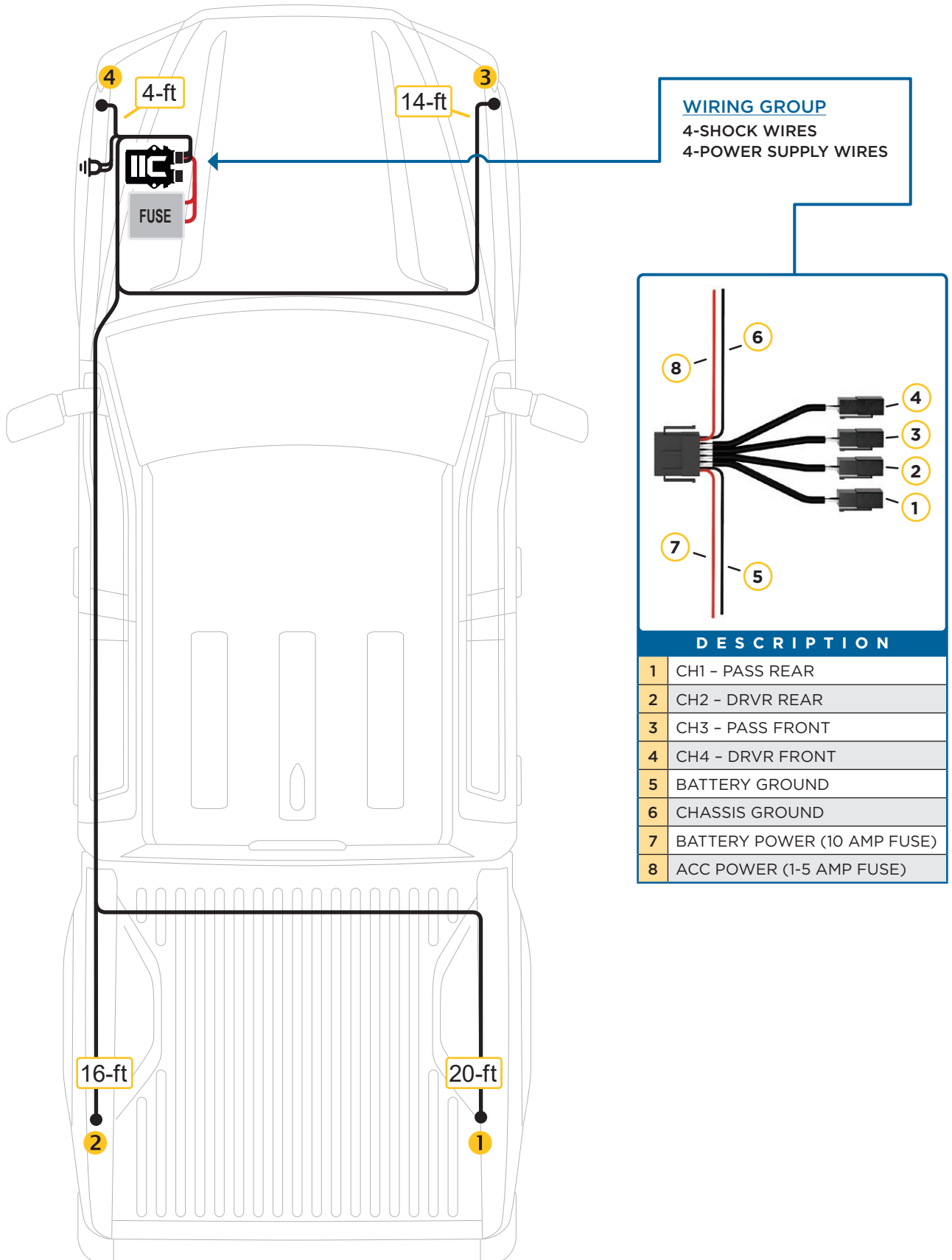

WIRE ROUTING DIAGRAM: 2024 Land Cruiser 250

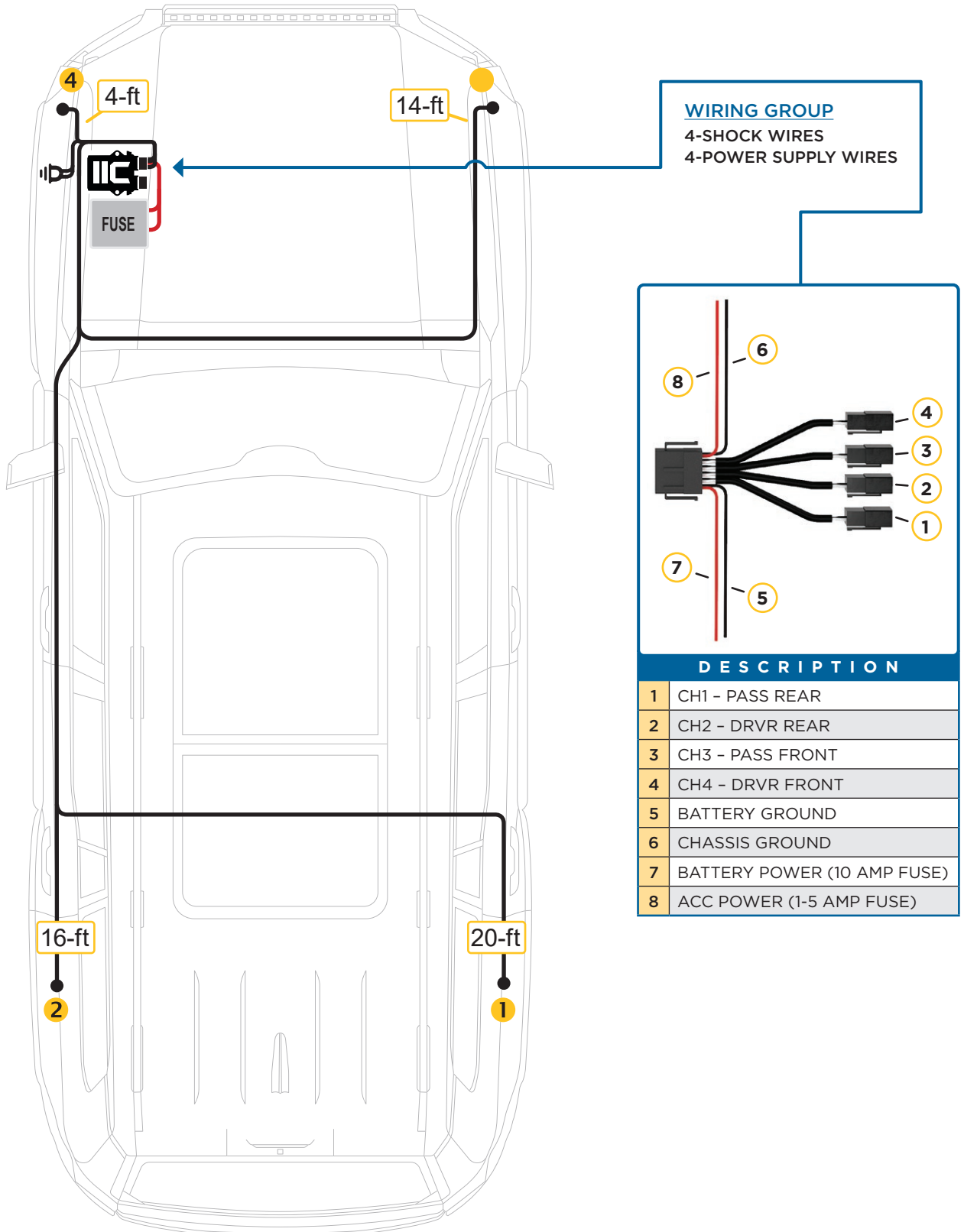

7929 Lincoln Ave. Riverside, CA 92504
 Phone: 951.689.ICON | Fax: 951.689.1016

PART #	DESCRIPTION
55160	24 TACOMA FRONT DIFF DROP

COMPONENTS INCLUDED	
(1) 154190 24 TACOMA DIFF DROP DRIVER	(1) 154191 24 TACOMA DIFF DROP PASSENGER
HARDWARE INCLUDED	
(2) 605990 M16 X 1.5 HEX LOCK NUT CL8 (1) 605968 VIBRATITE BLUE 2ML BULLET	(4) 297028 HAT BUSHING 1.375 X .875 X .775 (2) 157563 SLEEVE .875 X .640 X 2.690
TOOLS REQUIRED	
FLOOR JACK JACK STANDS TORQUE WRENCH	PRY BAR 19MM 22MM 12MM HEX KEY
TECH NOTES	
<p>1. INSTALL TIME: 30 MINUTES.</p> <p>2. AFTER INSTALL CHECK FLUE LEVEL AFTER DIFF ANGLE CHANGE MAKING SURE IT IS FULL.</p>	



WARNING!

**** READ ALL INSTRUCTIONS THOROUGHLY FROM START TO FINISH BEFORE BEGINNING INSTALLATION! IF THESE INSTRUCTIONS ARE NOT PROPERLY FOLLOWED SEVERE FRAME, SUSPENSION AND TIRE DAMAGE MAY RESULT TO THE VEHICLE!**

**** ICON VEHICLE DYNAMICS RECOMMENDS THAT YOU EXERCISE EXTREME CAUTION WHEN WORKING UNDER A VEHICLE THAT IS SUPPORTED WITH JACK STANDS.**

**** ICON VEHICLE DYNAMICS RECOMMENDS ALL INSTALLATION TO BE PERFORMED BY A PROFESSIONAL SHOP/SERVICE TECHNICIAN. PRODUCT FAILURE CAUSED BY IMPROPER INSTALLATION WILL NOT BE COVERED UNDER ICON'S WARRANTY POLICY.**

INSTALLATION

- Place the truck on a flat surface with the parking brake engaged, chock the rear tires.
- Use a suitable floor jack in the manufacturer designated spot on the frame to lift the front of the truck, then place a suitable jack stand under the frame and set the truck down securely on the jack stand. NEVER WORK UNDER AN UNSUPPORTED VEHICLE.
- Use the floor jack to support the front differential.

- Remove the 12mm bolts and nuts from the diff mounts at the frame using a 19mm. [FIGURE 1 & 2]

FIG.1



FIG.2



5. Remove the two 12mm bolts from the driver side diff mount at the diff using a 19mm (These bolts will be reused). [FIGURE 3]

FIG.3



6. Remove the two 16mm bolts from the passenger side diff mounts at the diff using a 22mm (These bolts will be reused). [FIGURE 4]

FIG.4



7. Assemble the bushings and sleeves into the new differential mounts. Apply a high quality moly grease to all surfaces of the bushings before pressing them into the mounts. Press the sleeves into the bushings once installed in the mount.

8. Using a 12mm hex key loosen the rear diff mount.

9. Install the mounts into the frame tabs and onto the diff. The Driver side first, use the OEM bolt and nut on the frame side and the differential side. Do not tighten yet. [FIGURE 5 & 6]

FIG.5



FIG.6

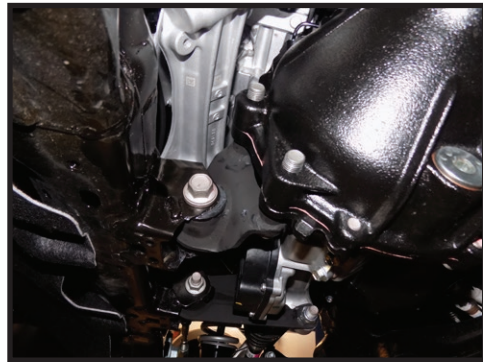

10. Install the passenger mount now reusing all OEM hardware and the two supplied M16 nuts. [FIGURE 7 & 8]

FIG.7

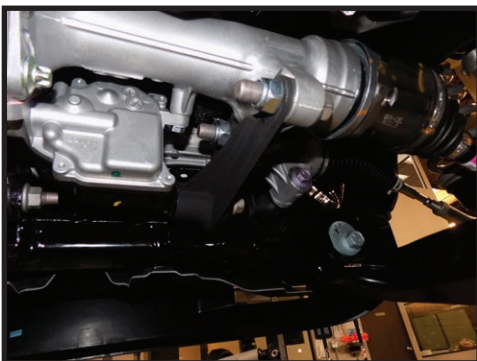

FIG.8



11. Once all the bolts are installed, begin torquing them as follows.
12. M12 bolt and nut: 70 ft-lbs.
13. M16 bolts and nuts on passenger mount: 150 ft-lbs
14. M12 hex key torque to 74 ft-lbs.
15. Be sure to check fluid in the differential making sure it filled to the correct level after differential angle change.

VERIFY ALL FASTENERS ARE PROPERLY TORQUED BEFORE DRIVING VEHICLE.

RETORQUE ALL NUTS, BOLTS AND LUGS AFTER 100 MILES AND PERIODICALLY THEREAFTER.

ICON VEHICLE DYNAMICS LIMITED LIFETIME WARRANTY

ICON Vehicle Dynamics warrants to the original retail purchaser who owns the vehicle on which the product was originally installed. ICON Vehicle Dynamics does not warrant the product for finish, alterations, modifications and/or installation contrary to ICON Vehicle Dynamics instructions. ICON Vehicle Dynamics products are not designed, nor are they intended to be installed on vehicles used in race applications, for racing purposes or for similar activities. (A "race" is defined as any contest between two or more vehicles, or a contest of one or more vehicles against the clock, whether or not such contest is for a prize). This warranty does not include coverage for police or taxi vehicles, race vehicles, or vehicles used for government or commercial purposes. Also excluded from this warranty are sales outside of the United States of America and Canada.

ICON Vehicle Dynamics' obligation under this warranty is limited to the repair or replacement, at ICON Vehicle Dynamics' discretion, of the defective product. Any and all costs of removal, installation or re-installation, freight charges and incidental or consequential damages are expressly excluded from this warranty. Items that are subject to wear are not considered defective when worn and are not covered.

ICON Vehicle Dynamics components must be installed as a complete kit as shown in our current application guide. Any substitutions or exemptions of required components will immediately void the warranty. Some finish damage may happen to parts during shipping and is not covered under warranty.

This warranty is expressly in lieu of all other warranties expressed or implied. This warranty shall not apply to any product that has been improperly installed, modified or customized subject to accident, negligence, abuse or misuse.



ICON VEHICLE DYNAMICS®
PERFORMANCE SUSPENSION SYSTEMS AND SHOCK ABSORBERS

7929 Lincoln Ave. Riverside, CA 92504 Phone: 951.689.ICON Fax: 951.689.1016
www.iconvehicledynamics.com



FOLLOW US ON FACEBOOK!



7929 Lincoln Ave. Riverside, CA 92504
Phone: 951.689.ICON | Fax: 951.689.1016

PART #	DESCRIPTION
58452DJ	24 TACOMA 24 LC250 24 GX550 UCA KIT

COMPONENTS INCLUDED	
(1) 154098 24 TACOMA LC 250 GX550 TUBULAR UCA DRVR	(1) 154098 24 TACOMA LC 250 GX550 TUBULAR UCA PASS
HARDWARE INCLUDED	
(8) 150026 WASHER 2.125 X .630 X .188 CZINC (4) 157560 SLEEVE 1.00 X 16MM X 2.310 CZINC (8) 297034 HAT BUSHING 1.625 X 1.000 X .850 (4) 297042 POLY RING 1.590 X 1.005 X .250 (2) 297166 DELTA JOINT PRO TUBULAR UCA DUST COVER	(2) 605800 M6-1.00 FLANGE NUT DR10.9 YZIC (2) 605862 M6-1.00 X 25MM SHSS 18-8 RAW (8) 605002 6-32 X 0.500 SHCS 18-8 RAW (2) 605890 M14 FENDER WASHER 36MM OD (1) 605969 VIBRATITE RED 2ML BULLE
TOOLS REQUIRED	
JACK JACK STANDS #2 PHILLIPS SCREWDRIVER BODY CLIP REMOVAL TOOL SMALL FLAT BLADE SCREWDRIVER NEEDLE NOSE PLIERS TORQUE WRENCH	10MM SOCKET / WRENCH 12MM SOCKET / WRENCH 19MM SOCKET / WRENCH 22MM SOCKET / WRENCH 3/8 12-PT
TECH NOTES	
<p>1. ICON DELTA JOINTS ARE PRE-GREASED FROM THE FACTORY. ICON RECOMMENDS GREASING THE DELTA JOINT EVERY 3,000 MILES (OR EVERY OIL CHANGE). ADD NEW GREASE UNTIL ALL OF THE OLD GREASE IS EXPELLED FROM THE BOTTOM OF THE DELTA JOINT ASSEMBLY, WIPE AWAY EXCESS WITH A RAG OR SHOP TOWEL.</p> <p>2. ALL ICON UPPER CONTROL ARMS HAVE BEEN ENGINEERED TO ALLOW FOR THE MOST POSSIBLE CASTER, WHILE STILL ALLOWING THE VEHICLE TO BE PROPERLY ALIGNED. NOTIFY YOUR PROFESSIONAL ALIGNMENT SHOP OF THIS INFORMATION SO THAT MAXIMUM RIDE QUALITY CAN BE ACHIEVED.</p> <p>3. ESTIMATED INSTALL TIME: 2.5 HOURS.</p>	



WARNING!
<p>** READ ALL INSTRUCTIONS THOROUGHLY FROM START TO FINISH BEFORE BEGINNING INSTALLATION! IF THESE INSTRUCTIONS ARE NOT PROPERLY FOLLOWED SEVERE FRAME, SUSPENSION AND TIRE DAMAGE MAY RESULT TO THE VEHICLE!</p> <p>** ICON VEHICLE DYNAMICS RECOMMENDS THAT YOU EXERCISE EXTREME CAUTION WHEN WORKING UNDER A VEHICLE THAT IS SUPPORTED WITH JACK STANDS.</p> <p>** ICON VEHICLE DYNAMICS RECOMMENDS ALL INSTALLATION TO BE PERFORMED BY A PROFESSIONAL SHOP/SERVICE TECHNICIAN. PRODUCT FAILURE CAUSED BY IMPROPER INSTALLATION WILL NOT BE COVERED UNDER ICON'S WARRANTY POLICY.</p>

INSTALLATION

- Lift vehicle and securely place heavy duty jack stands under the manufacturer recommended lifting locations for the front of the vehicle. Take care when lifting the vehicle, and allow 3-4" of ground clearance from the tire. Remove front tires. NEVER WORK UNDER AN UNSUPPORTED VEHICLE. Remove the wheels.
- If installing on a GX550 continue to [Step 3]. If installing on a Tacoma, Land Cruiser 250 skip to [Step 13].
- Open the hood and disconnect the negative terminal on the battery using a 12mm and unplug the electrical connector.
- Unplug the electrical connector on the air intake tube. [FIGURE 1]

FIG.1



5. Remove the airbox. Loosen the hose clamp with a #2 phillips screwdriver or 10mm on the air intake hose located closest to the engine. [FIGURE 2]

FIG.2



6. Lift up on box and remove. The box is only held in place by the intake tube and rubber grommets underneath.

7. With the box removed, remove the wiring clips from the ECU bracket. [FIGURE 3 & 4]

FIG.3



FIG.4

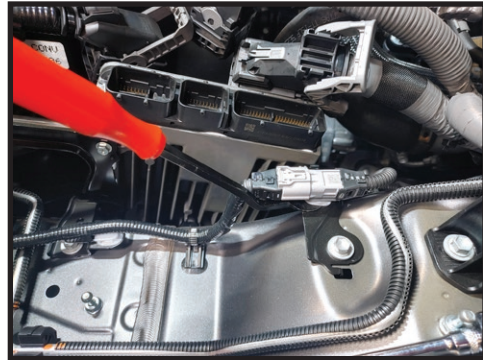

8. Unplug the small grey connector next to the ECU.

9. Unplug the ECU harnesses from the ECU. Push down on the safety latch and push the lever the opposite way. The connector will lift up and you will be able to remove it completely. [FIGURE 5 & 6]

FIG.5



FIG.6



10. Remove the harness clamp from the large wire loom using a small flat blade screwdriver. [FIGURE 7]

FIG.7



11. Remove the large harness from the ECU. Press lock clip and pull up on the grey lever and pulling plug out. [FIGURE 8]

FIG.8

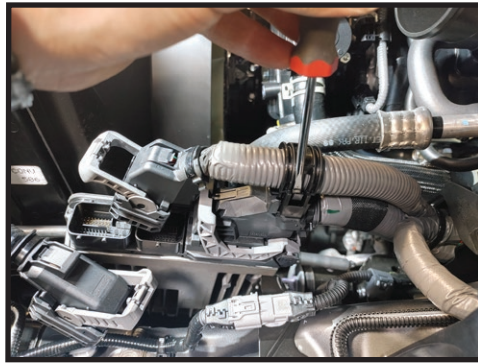

12. Remove (3) 10mm bolts from the ECU bracket. One on the front core support, two on the fender well. [FIGURE 9 & 10]

FIG.9

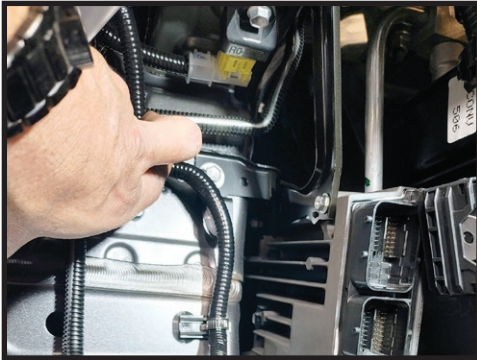

FIG.10



13. Remove the splash guards from the fender well using a needle nose pliers to pinch the clip and pull out. [FIGURE 11]

FIG.11



14. Remove the 12mm bolt from the top of the UCA that holds the ABS wire. [FIGURE 12]

FIG.12

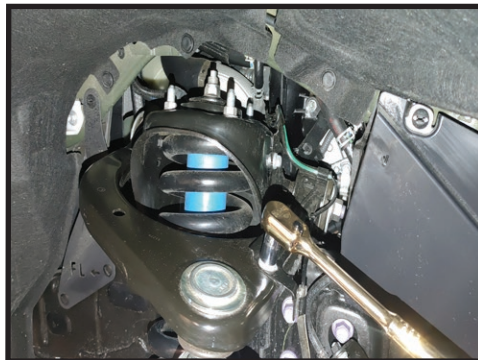

15. Remove the cotter pin from the UCA balljoint using a small screwdriver or pick to pry over the safety clip and pull out the pin using a needle nose pliers. Loosen the 19mm nut on the balljoint. [FIGURE 13 & 14]

FIG.13



FIG.14



16. Use a hammer or balljoint separator to loosen the balljoint taper from the spindle. [FIGURE 15]

FIG.15



17. Loosen and remove the UCA pivot bolt from the frame using a 22mm. [FIGURE 16]

FIG.16



18. If installing on a GX550 skip to [Step 20]. Locate the front driver side core support mount bushing. [FIGURE 17]

FIG.17



19. Using a jack carefully apply pressure to the driver front core support bolt this will lift the intercooler up enough to remove the UCA pivot bolt. [FIGURE 18 & 19]

FIG.18

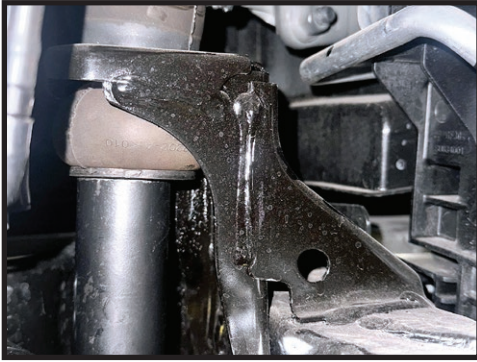
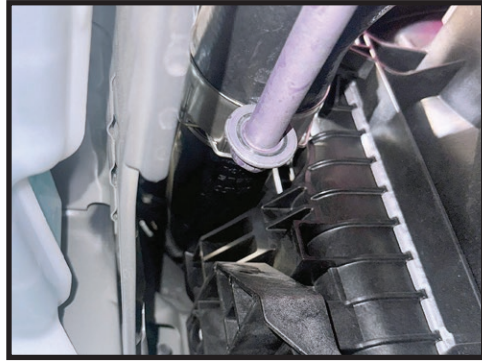

FIG.19



20. If installing on a GX550 remove the bolt from the UCA then remove the factory UCA. If installing on a LC250 or Tacoma remove factory UCA. [FIGURE 20]

FIG.20



21. Install the new bushings into the ICON tubular UCA as indicated by the drawing below. Grease the ID and OD bushing and the face before install. [FIGURE 21]

FIG.21

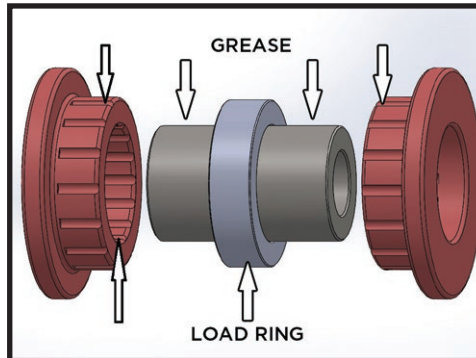

22. Install the ICON UCA into position and slide the factory mounting bolt through the heims, spacers and frame. [FIGURE 22 & 23]

FIG.22



FIG.23



23. Install the Delta Joint Pro into the spindle, apply included blue thread locker to threads on flange nut and thread on to Delta Joint Pro with washer (PN 605890) between the flange nut and spindle [Torque the nut to 70 ft-lbs]. [FIGURE 24]

FIG.24



24. Install the ABS bracket onto the Billet UCA using the factory bolt. [FIGURE 25]

FIG.25



25. Torque the factory long pivot bolt to OEM spec.

26. Install the supplied delta joint dust cap. [FIGURE 26]

FIG.26



27. If installing on a GX550 reinstall the ECU and airbox in reverse order of removal.

28. Repeat [Steps 2-15] on passenger side. There is no need for the jack on the core support on the passenger side.

29. Reinstall wheels and tires and carefully lower vehicle to the ground. Torque lug nuts to factory spec.

***VERIFY ALL FASTENERS ARE PROPERLY TORQUED BEFORE DRIVING VEHICLE.
RETORQUE ALL NUTS, BOLTS AND LUGS AFTER 100 MILES AND PERIODICALLY THEREAFTER.***

ICON VEHICLE DYNAMICS LIMITED LIFETIME WARRANTY

ICON Vehicle Dynamics warrants to the original retail purchaser who owns the vehicle on which the product was originally installed. ICON Vehicle Dynamics does not warrant the product for finish, alterations, modifications and/or installation contrary to ICON Vehicle Dynamics instructions. ICON Vehicle Dynamics products are not designed, nor are they intended to be installed on vehicles used in race applications, for racing purposes or for similar activities. (A "race" is defined as any contest between two or more vehicles, or a contest of one or more vehicles against the clock, whether or not such contest is for a prize). This warranty does not include coverage for police or taxi vehicles, race vehicles, or vehicles used for government or commercial purposes. Also excluded from this warranty are sales outside of the United States of America and Canada.

ICON Vehicle Dynamics' obligation under this warranty is limited to the repair or replacement, at ICON Vehicle Dynamics' discretion, of the defective product. Any and all costs of removal, installation or re-installation, freight charges and incidental or consequential damages are expressly excluded from this warranty. Items that are subject to wear are not considered defective when worn and are not covered.

ICON Vehicle Dynamics components must be installed as a complete kit as shown in our current application guide. Any substitutions or exemptions of required components will immediately void the warranty. Some finish damage may happen to parts during shipping and is not covered under warranty.

This warranty is expressly in lieu of all other warranties expressed or implied. This warranty shall not apply to any product that has been improperly installed, modified or customized subject to accident, negligence, abuse or misuse.



ICON VEHICLE DYNAMICS®
PERFORMANCE SUSPENSION SYSTEMS AND SHOCK ABSORBERS

7929 Lincoln Ave. Riverside, CA 92504 Phone: 951.689.ICON Fax: 951.689.1016
www.iconvehicledynamics.com



FOLLOW US ON FACEBOOK!

