

7929 Lincoln Ave. Riverside, CA 92504  
Phone: 951.689.ICON | Fax: 951.689.1016

PART #	DESCRIPTION
51213	24 TACOMA .75" LIFT TRIPLE RATE REAR COIL SPRING KIT

COMPONENTS INCLUDED	
(2) 158573 24 TACOMA .75" LIFT TRIPLE RATE COIL SPRING	
HARDWARE INCLUDED	
N/A	
TOOLS REQUIRED	
JACK JACK STANDS TORQUE WRENCH RATCHETS	12MM SOCKET/WRENCH 17MM SOCKET / WRENCH COIL SPRING COMPRESSOR
TECH NOTES	
1. ESTIMATED INSTALL TIME: 2 HOURS.	



WARNING!
** READ ALL INSTRUCTIONS THOROUGHLY FROM START TO FINISH BEFORE BEGINNING INSTALLATION! IF THESE INSTRUCTIONS ARE NOT PROPERLY FOLLOWED SEVERE FRAME, SUSPENSION AND TIRE DAMAGE MAY RESULT TO THE VEHICLE!
** ICON VEHICLE DYNAMICS RECOMMENDS THAT YOU EXERCISE EXTREME CAUTION WHEN WORKING UNDER A VEHICLE THAT IS SUPPORTED WITH JACK STANDS.
** ICON VEHICLE DYNAMICS RECOMMENDS ALL INSTALLATION TO BE PERFORMED BY A PROFESSIONAL SHOP/SERVICE TECHNICIAN. PRODUCT FAILURE CAUSED BY IMPROPER INSTALLATION WILL NOT BE COVERED UNDER ICON'S WARRANTY POLICY.

## INSTALLATION

Place vehicle in park on a level surface. Engage parking brake. Block the front tires. Lift rear of vehicle and place jack stands under the manufacturer recommended locations. NEVER WORK UNDER AN UNSUPPORTED VEHICLE.

**OPTION 1:** No spring compressor available.

1. Place a jack under the center of the axle so it can be lowered to assist in spring removal.
2. Using a 12mm, remove the brake line, E-brake line, speed sensor and E-locker wiring brackets.
3. Remove the lower shock eyelet using a 17mm and pull the shock off the mounting stud. [FIGURE 1]

FIG.1



4. Slowly lower the axle down until the springs become loose, being careful not to overextend any brake lines or wiring harness.
5. Lift the spring and pull it out from the bottom, rotating it can help to clear the mount on the axle housing spring perch.
6. Remove the bump stop cone from the factory spring and install it into the new ICON spring, then install it into the truck. Being sure the lower spring seat is in the spring perch correctly. Repeat on passenger side.
7. Reinstall shocks and brake lines.

**OPTION 2:** Use a spring compressor.

**1.** Use a spring compressor like the one shown. [FIGURE 2]

FIG.2



**2.** Leave all brackets attached. Remove the lower shock mount with a 17mm and lower the axle, being sure not to overextend any brake lines or wiring harness.

**3.** Install spring compressor with appropriate spring attachment and tighten to compress the spring until it can be removed. [FIGURE 3]

FIG.3



**4.** Remove the spring compressor from the factory spring and install it onto the new ICON spring.

**5.** Remove the bump stop cone from the factory spring and install it into the new ICON spring. Compress the spring enough so that it can be installed into the truck, making sure the spring seats into the upper and lower spring perch correctly. Repeat on passenger side.

**6.** Reinstall wheels and tires, enjoy your new springs and ride.

***VERIFY ALL FASTENERS ARE PROPERLY TORQUED BEFORE DRIVING VEHICLE.***

***RETORQUE ALL NUTS, BOLTS AND LUGS AFTER 100 MILES AND PERIODICALLY THEREAFTER.***

## ICON VEHICLE DYNAMICS LIMITED LIFETIME WARRANTY

ICON Vehicle Dynamics warrants to the original retail purchaser who owns the vehicle on which the product was originally installed. ICON Vehicle Dynamics does not warrant the product for finish, alterations, modifications and/or installation contrary to ICON Vehicle Dynamics instructions. ICON Vehicle Dynamics products are not designed, nor are they intended to be installed on vehicles used in race applications, for racing purposes or for similar activities. (A "race" is defined as any contest between two or more vehicles, or a contest of one or more vehicles against the clock, whether or not such contest is for a prize). This warranty does not include coverage for police or taxi vehicles, race vehicles, or vehicles used for government or commercial purposes. Also excluded from this warranty are sales outside of the United States of America and Canada.

ICON Vehicle Dynamics' obligation under this warranty is limited to the repair or replacement, at ICON Vehicle Dynamics' discretion, of the defective product. Any and all costs of removal, installation or re-installation, freight charges and incidental or consequential damages are expressly excluded from this warranty. Items that are subject to wear are not considered defective when worn and are not covered.

ICON Vehicle Dynamics components must be installed as a complete kit as shown in our current application guide. Any substitutions or exemptions of required components will immediately void the warranty. Some finish damage may happen to parts during shipping and is not covered under warranty.

This warranty is expressly in lieu of all other warranties expressed or implied. This warranty shall not apply to any product that has been improperly installed, modified or customized subject to accident, negligence, abuse or misuse.



**ICON VEHICLE DYNAMICS®**  
PERFORMANCE SUSPENSION SYSTEMS AND SHOCK ABSORBERS

7929 Lincoln Ave. Riverside, CA 92504 Phone: 951.689.ICON Fax: 951.689.1016  
[www.iconvehicledynamics.com](http://www.iconvehicledynamics.com)



**FOLLOW US ON FACEBOOK!**



7929 Lincoln Ave. Riverside, CA 92504  
Phone: 951.689.ICON | Fax: 951.689.1016

PART #	DESCRIPTION
55160	24 TACOMA FRONT DIFF DROP

COMPONENTS INCLUDED	
(1) 154190 24 TACOMA DIFF DROP DRIVER	(1) 154191 24 TACOMA DIFF DROP PASSENGER
HARDWARE INCLUDED	
(2) 605990 M16 X 1.5 HEX LOCK NUT CL8 (1) 605968 VIBRATITE BLUE 2ML BULLET	(4) 297028 HAT BUSHING 1.375 X .875 X .775 (2) 157563 SLEEVE .875 X .640 X 2.690
TOOLS REQUIRED	
FLOOR JACK JACK STANDS TORQUE WRENCH	PRY BAR 19MM 22MM 12MM HEX KEY
TECH NOTES	
1. INSTALL TIME: 30 MINUTES.	
2. AFTER INSTALL CHECK FLUE LEVEL AFTER DIFF ANGLE CHANGE MAKING SURE IT IS FULL.	



WARNING!
** READ ALL INSTRUCTIONS THOROUGHLY FROM START TO FINISH BEFORE BEGINNING INSTALLATION! IF THESE INSTRUCTIONS ARE NOT PROPERLY FOLLOWED SEVERE FRAME, SUSPENSION AND TIRE DAMAGE MAY RESULT TO THE VEHICLE!
** ICON VEHICLE DYNAMICS RECOMMENDS THAT YOU EXERCISE EXTREME CAUTION WHEN WORKING UNDER A VEHICLE THAT IS SUPPORTED WITH JACK STANDS.
** ICON VEHICLE DYNAMICS RECOMMENDS ALL INSTALLATION TO BE PERFORMED BY A PROFESSIONAL SHOP/SERVICE TECHNICIAN. PRODUCT FAILURE CAUSED BY IMPROPER INSTALLATION WILL NOT BE COVERED UNDER ICON'S WARRANTY POLICY.

## INSTALLATION

- Place the truck on a flat surface with the parking brake engaged, chock the rear tires.
- Use a suitable floor jack in the manufacturer designated spot on the frame to lift the front of the truck, then place a suitable jack stand under the frame and set the truck down securely on the jack stand. NEVER WORK UNDER AN UNSUPPORTED VEHICLE.
- Use the floor jack to support the front differential.

- Remove the 12mm bolts and nuts from the diff mounts at the frame using a 19mm. [FIGURE 1 & 2]

FIG.1



FIG.2



5. Remove the two 12mm bolts from the driver side diff mount at the diff using a 19mm (These bolts will be reused). [FIGURE 3]

FIG.3



6. Remove the two 16mm bolts from the passenger side diff mounts at the diff using a 22mm (These bolts will be reused). [FIGURE 4]

FIG.4



7. Assemble the bushings and sleeves into the new differential mounts. Apply a high quality moly grease to all surfaces of the bushings before pressing them into the mounts. Press the sleeves into the bushings once installed in the mount.

8. Using a 12mm hex key loosen the rear diff mount.

9. Install the mounts into the frame tabs and onto the diff. The Driver side first, use the OEM bolt and nut on the frame side and the differential side. Do not tighten yet. [FIGURE 5 & 6]

FIG.5



FIG.6

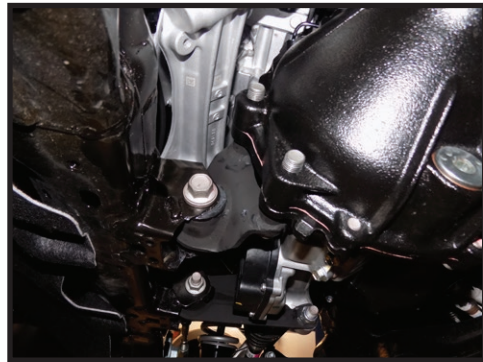

10. Install the passenger mount now reusing all OEM hardware and the two supplied M16 nuts. [FIGURE 7 & 8]

FIG.7

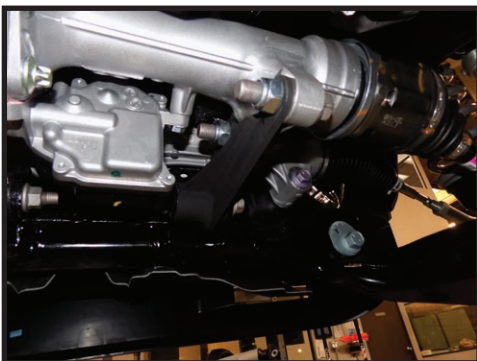

FIG.8



11. Once all the bolts are installed, begin torquing them as follows.
12. M12 bolt and nut: 70 ft-lbs.
13. M16 bolts and nuts on passenger mount: 150 ft-lbs
14. M12 hex key torque to 74 ft-lbs.
15. Be sure to check fluid in the differential making sure it filled to the correct level after differential angle change.

**VERIFY ALL FASTENERS ARE PROPERLY TORQUED BEFORE DRIVING VEHICLE.**

**RETORQUE ALL NUTS, BOLTS AND LUGS AFTER 100 MILES AND PERIODICALLY THEREAFTER.**

### **ICON VEHICLE DYNAMICS LIMITED LIFETIME WARRANTY**

ICON Vehicle Dynamics warrants to the original retail purchaser who owns the vehicle on which the product was originally installed. ICON Vehicle Dynamics does not warrant the product for finish, alterations, modifications and/or installation contrary to ICON Vehicle Dynamics instructions. ICON Vehicle Dynamics products are not designed, nor are they intended to be installed on vehicles used in race applications, for racing purposes or for similar activities. (A "race" is defined as any contest between two or more vehicles, or a contest of one or more vehicles against the clock, whether or not such contest is for a prize). This warranty does not include coverage for police or taxi vehicles, race vehicles, or vehicles used for government or commercial purposes. Also excluded from this warranty are sales outside of the United States of America and Canada.

ICON Vehicle Dynamics' obligation under this warranty is limited to the repair or replacement, at ICON Vehicle Dynamics' discretion, of the defective product. Any and all costs of removal, installation or re-installation, freight charges and incidental or consequential damages are expressly excluded from this warranty. Items that are subject to wear are not considered defective when worn and are not covered.

ICON Vehicle Dynamics components must be installed as a complete kit as shown in our current application guide. Any substitutions or exemptions of required components will immediately void the warranty. Some finish damage may happen to parts during shipping and is not covered under warranty.

This warranty is expressly in lieu of all other warranties expressed or implied. This warranty shall not apply to any product that has been improperly installed, modified or customized subject to accident, negligence, abuse or misuse.



**ICON VEHICLE DYNAMICS®**  
PERFORMANCE SUSPENSION SYSTEMS AND SHOCK ABSORBERS

7929 Lincoln Ave. Riverside, CA 92504 Phone: 951.689.ICON Fax: 951.689.1016  
[www.iconvehicledynamics.com](http://www.iconvehicledynamics.com)



**FOLLOW US ON FACEBOOK!**



7929 Lincoln Ave. Riverside, CA 92504  
 Phone: 951.689.ICON | Fax: 951.689.1016

PART #	DESCRIPTION
57808P	24 TUNDRA 0-1" REAR 2.5 VS RR PAIR

### COMPONENTS INCLUDED

(2) 154604R 24 TACOMA 2.5 0-1" REAR VS RR UNPKG

### HARDWARE INCLUDED

(2) 150145 24 TACOMA REAR RESI MOUNT  
 (2) 605144 3/8-12 X .750 FLANGED SELF TAP BOLT CZINC

(2) 611008 9/16 RXT HEAVY DUTY STEM BUSHING KIT  
 (2) 611051 #36 1.188-2.750 STAINLESS HOSE CLAMP KIT (4)

### TOOLS REQUIRED

JACK  
 JACK STANDS  
 TORQUE WRENCH  
 RATCHETS  
 EXTENSION  
 DRILL  
 11/32 DRILL BIT

SHARPIE  
 8MM  
 17MM  
 19MM  
 9/16"  
 5/16" NUT DRIVER OR FLAT BLADE SCREW DRIVER

### TECH NOTES

1. YOUR ICON SHOCK ASSEMBLIES COME FACTORY CHARGED TO 250 PSI. RELEASING NITROGEN PRESSURE MAY LEAD TO SHOCK MALFUNCTION AND REDUCED RIDE QUALITY. FAILURE CAUSED BY LOW NITROGEN PRESSURE IS NOT COVERED UNDER ICON'S WARRANTY POLICY.
2. BE CAUTIOUS WHEN LOWERING THE AXLE WITHOUT THE SHOCKS ATTACHED, THE BRAKE LINES CAN BECOME STRETCHED AND CAUSE DAMAGE.
3. ESTIMATED INSTALL TIME: 1.5 HOURS



### WARNING!

**\*\* READ ALL INSTRUCTIONS THOROUGHLY FROM START TO FINISH BEFORE BEGINNING INSTALLATION! IF THESE INSTRUCTIONS ARE NOT PROPERLY FOLLOWED SEVERE FRAME, SUSPENSION AND TIRE DAMAGE MAY RESULT TO THE VEHICLE!**

**\*\* ICON VEHICLE DYNAMICS RECOMMENDS THAT YOU EXERCISE EXTREME CAUTION WHEN WORKING UNDER A VEHICLE THAT IS SUPPORTED WITH JACK STANDS.**

**\*\* ICON VEHICLE DYNAMICS RECOMMENDS ALL INSTALLATION TO BE PERFORMED BY A PROFESSIONAL SHOP/SERVICE TECHNICIAN. PRODUCT FAILURE CAUSED BY IMPROPER INSTALLATION WILL NOT BE COVERED UNDER ICON'S WARRANTY POLICY.**

## INSTALLATION

1. Lift vehicle and securely place heavy duty jack stands under the manufacturer recommended lifting locations for the rear of the vehicle. Take care when lifting the vehicle and allow 3-4" of ground clearance from the tire. Remove front tires. NEVER WORK UNDER AN UNSUPPORTED VEHICLE. Remove the wheels.
2. Support the rear axle.
3. Remove the upper nut using an 8mm to hold the stud and 19mm to remove the nut. [FIGURE 1]



FIG.1

4. Remove the lower bolt using a 17mm. [FIGURE 2]



FIG.2

**5.** Install optional shock boot securing the top of the boot with the supplied zip-tie.

**6.** Install the new Icon stem bushings onto the Icon shock. Place the washer with the bigger hole on, then a bushing. Place the stem into the upper shock mount, then another bushing and the washer, thread on one of the supplied nuts, tighten it down until the second nut can on and 3-4 thread show with both nuts installed. [FIGURE 3]

FIG.3



**7.** Install the lower eyelet of the Icon shock onto the axle stud. Use the supplied sleeves to position the eyelet correctly. Sleeve, shock eyelet, sleeve. Use the factory bolt and torque to factory specs. [FIGURE 4 & 5]

FIG.4



FIG.5



**8.** For reservoir mounting, use the supplied reservoir bracket and hold the reservoir and bracket up to the frame as shown, and mark the hole to drill it to 11/32" (SHOCK APPEARANCE MAY CHANGE DUE TO ONGOING DEVELOPMENT). [FIGURE 6]

FIG.6



**9.** With the hole drilled, take the supplied 3/8" self-tap flanged bolt and reservoir bracket and install onto the frame.

**10.** Using the supplied hose clamps, clamp the reservoir onto the bracket as shown (If desired, the supplied heat shrink material can be cut to fit over the hose clamps). [FIGURE 7, 8, 9, 10]

FIG.7



FIG.8



FIG.9



FIG.10



**11.** With the shocks installed. Reinstall the wheels and tires, lower to the ground and torque the lug nuts to factory spec.

***VERIFY ALL FASTENERS ARE PROPERLY TORQUED BEFORE DRIVING VEHICLE.***

***RETORQUE ALL NUTS, BOLTS AND LUGS AFTER 100 MILES AND PERIODICALLY THEREAFTER.***

## 2.5 VS SERIES SHOCK & COILOVER TECHNICAL INFORMATION

### MAINTENANCE

ICON shock absorbers are a high quality rebuildable race style shock absorber designed for optimal performance. With a unit of this caliber on your vehicle, routine maintenance is required to keep them looking and operating in like new condition. Residual oil and assembly lube may be present at all seal paths from the factory out of the box and is considered normal. Pooling of oil however is not acceptable at any time and one should contact the ICON dealer where purchased.

**BELOW ARE GUIDELINES BASED ON HOW YOU USE YOUR VEHICLE BUT YOUR MILEAGE MAY VARY:**

#### **STREET USE:**

- Send in for factory servicing every 40,000 miles or if a leak develops, ride quality decreases, or they begin to make excessive noise.
- Remove any buildup of road salt, mud, or debris from shocks and coil springs anytime accrued
- Clean with mild soap and water with each oil change or anytime you notice build up.
- Wax the cylinders yearly with automotive wax to prevent corrosion.
- Check nitrogen pressure yearly. (252004 charge needle assembly available at any ICON distributor)
- Check bearings for excessive wear yearly.
- DO NOT apply any type of lube to the upper and lower bearings.

#### **STREET/DIRT:**

- Send in for factory servicing every 15,000 miles or if a leak develops, ride quality decreases, or they begin to make excessive noise.
- Clean with mild soap and water with each oil change, offroad trip, or anytime you notice build up.
- Wax the cylinders yearly with automotive wax to prevent corrosion.
- Check nitrogen pressure each dirt outing. (252004 charge needle assembly available at any ICON distributor)
- Check bearings for excessive wear yearly.
- DO NOT apply any type of lube to the upper and lower bearings.

#### **DIRT USE:**

- Send in for factory servicing every 1,000 miles.
- Check nitrogen pressure each outing. (252004 charge needle assembly available at any ICON distributor)
- Remove any buildup of mud or debris from shocks and coil springs after every outing.

#### **SELF-SERVICE:**

- Contact ICON for service kits & tools at (951) 689-4266.

### PRODUCT REGISTRATION

Please visit: <http://www.iconvehicledynamics.com/tech-support/registration/> to register your product.

### ICON VEHICLE DYNAMICS SHOCK ABSORBER WARRANTY

This shock absorber has a 1 year warranty against any manufacturer's defects. If a shock fails within the initial year of ownership, the shock must be shipped to ICON Vehicle Dynamics for inspection and service. If a shock is inspected and it has been determined the shock failed due to neglect, damage caused by improper installation or any other reason besides "normal wear and tear", the owner of said shock is responsible for all service costs. This includes labor, parts, and shipping.

ICON Vehicle Dynamics warrants to the original retail purchaser who owns the vehicle on which the product was originally installed. ICON Vehicle Dynamics does not warrant the product for finish, alterations, modifications and/or installation contrary to ICON Vehicle Dynamics instructions. ICON Vehicle Dynamics products are not designed, nor are they intended to be installed on vehicles used in race applications, for racing purposes or for similar activities. (A "race" is defined as any contest between two or more vehicles, or a contest of one or more vehicles against the clock, whether or not such contest is for a prize). This warranty does not include coverage for police or taxi vehicles, race vehicles, or vehicles used for government or commercial purposes. Also excluded from this warranty are sales outside of the United States of America and Canada.

ICON Vehicle Dynamics' obligation under this warranty is limited to the repair or replacement, at ICON Vehicle Dynamics' discretion, of the defective product. Any and all costs of removal, installation or re-installation, freight charges and incidental or consequential damages are expressly excluded from this warranty. Items that are subject to wear are not considered defective when worn and are not covered.

ICON Vehicle Dynamics components must be installed as a complete kit as shown in our current application guide. Any substitutions or exemptions of required components will immediately void the warranty. Some finish damage may happen to parts during shipping and is not covered under warranty.

This warranty is expressly in lieu of all other warranties expressed or implied. This warranty shall not apply to any product that has been improperly installed, modified or customized subject to accident, negligence, abuse or misuse.

To send a shock in for warranty please visit our website <http://www.iconvehicledynamics.com/tech-support/shock-service/>



**ICON VEHICLE DYNAMICS®**  
PERFORMANCE SUSPENSION SYSTEMS AND SHOCK ABSORBERS

7929 Lincoln Ave. Riverside, CA 92504 Phone: 951.689.ICON Fax: 951.689.1016  
[www.iconvehicledynamics.com](http://www.iconvehicledynamics.com)



**FOLLOW US ON FACEBOOK!**



7929 Lincoln Ave. Riverside, CA 92504  
Phone: 951.689.ICON | Fax: 951.689.1016

PART #	DESCRIPTION
58452DJ	24 TACOMA 24 LC250 24 GX550 UCA KIT

COMPONENTS INCLUDED	
(1) 154098 24 TACOMA LC 250 GX550 TUBULAR UCA DRVR	(1) 154098 24 TACOMA LC 250 GX550 TUBULAR UCA PASS
HARDWARE INCLUDED	
(8) 150026 WASHER 2.125 X .630 X .188 CZINC (4) 157560 SLEEVE 1.00 X 16MM X 2.310 CZINC (8) 297034 HAT BUSHING 1.625 X 1.000 X .850 (4) 297042 POLY RING 1.590 X 1.005 X .250 (2) 297166 DELTA JOINT PRO TUBULAR UCA DUST COVER	(2) 605800 M6-1.00 FLANGE NUT DR10.9 YZIC (2) 605862 M6-1.00 X 25MM SHSS 18-8 RAW (8) 605002 6-32 X 0.500 SHCS 18-8 RAW (2) 605890 M14 FENDER WASHER 36MM OD (1) 605969 VIBRATITE RED 2ML BULLE
TOOLS REQUIRED	
JACK JACK STANDS #2 PHILLIPS SCREWDRIVER BODY CLIP REMOVAL TOOL SMALL FLAT BLADE SCREWDRIVER NEEDLE NOSE PLIERS TORQUE WRENCH	10MM SOCKET / WRENCH 12MM SOCKET / WRENCH 19MM SOCKET / WRENCH 22MM SOCKET / WRENCH 3/8 12-PT
TECH NOTES	
<p>1. ICON DELTA JOINTS ARE PRE-GREASED FROM THE FACTORY. ICON RECOMMENDS GREASING THE DELTA JOINT EVERY 3,000 MILES (OR EVERY OIL CHANGE). ADD NEW GREASE UNTIL ALL OF THE OLD GREASE IS EXPELLED FROM THE BOTTOM OF THE DELTA JOINT ASSEMBLY, WIPE AWAY EXCESS WITH A RAG OR SHOP TOWEL.</p> <p>2. ALL ICON UPPER CONTROL ARMS HAVE BEEN ENGINEERED TO ALLOW FOR THE MOST POSSIBLE CASTER, WHILE STILL ALLOWING THE VEHICLE TO BE PROPERLY ALIGNED. NOTIFY YOUR PROFESSIONAL ALIGNMENT SHOP OF THIS INFORMATION SO THAT MAXIMUM RIDE QUALITY CAN BE ACHIEVED.</p> <p>3. ESTIMATED INSTALL TIME: 2.5 HOURS.</p>	



WARNING!
<p><b>** READ ALL INSTRUCTIONS THOROUGHLY FROM START TO FINISH BEFORE BEGINNING INSTALLATION! IF THESE INSTRUCTIONS ARE NOT PROPERLY FOLLOWED SEVERE FRAME, SUSPENSION AND TIRE DAMAGE MAY RESULT TO THE VEHICLE!</b></p> <p><b>** ICON VEHICLE DYNAMICS RECOMMENDS THAT YOU EXERCISE EXTREME CAUTION WHEN WORKING UNDER A VEHICLE THAT IS SUPPORTED WITH JACK STANDS.</b></p> <p><b>** ICON VEHICLE DYNAMICS RECOMMENDS ALL INSTALLATION TO BE PERFORMED BY A PROFESSIONAL SHOP/SERVICE TECHNICIAN. PRODUCT FAILURE CAUSED BY IMPROPER INSTALLATION WILL NOT BE COVERED UNDER ICON'S WARRANTY POLICY.</b></p>

## INSTALLATION

- Lift vehicle and securely place heavy duty jack stands under the manufacturer recommended lifting locations for the front of the vehicle. Take care when lifting the vehicle, and allow 3-4" of ground clearance from the tire. Remove front tires. NEVER WORK UNDER AN UNSUPPORTED VEHICLE. Remove the wheels.
- If installing on a GX550 continue to [Step 3]. If installing on a Tacoma, Land Cruiser 250 skip to [Step 13].
- Open the hood and disconnect the negative terminal on the battery using a 12mm and unplug the electrical connector.
- Unplug the electrical connector on the air intake tube. [FIGURE 1]

FIG.1



**5.** Remove the airbox. Loosen the hose clamp with a #2 phillips screwdriver or 10mm on the air intake hose located closest to the engine. [FIGURE 2]

**FIG.2**

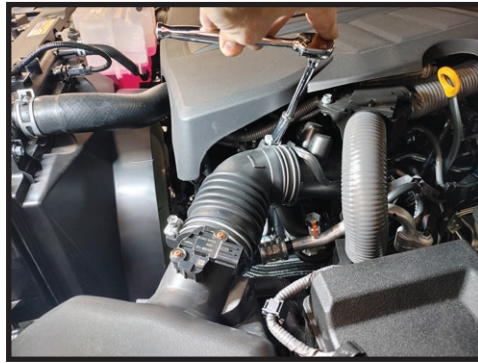

**6.** Lift up on box and remove. The box is only held in place by the intake tube and rubber grommets underneath.

**7.** With the box removed, remove the wiring clips from the ECU bracket. [FIGURE 3 & 4]

**FIG.3**



**FIG.4**

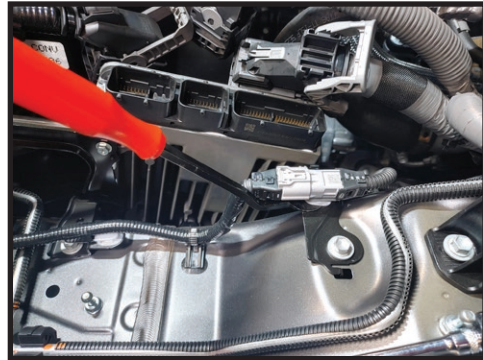

**8.** Unplug the small grey connector next to the ECU.

**9.** Unplug the ECU harnesses from the ECU. Push down on the safety latch and push the lever the opposite way. The connector will lift up and you will be able to remove it completely. [FIGURE 5 & 6]

**FIG.5**



**FIG.6**



**10.** Remove the harness clamp from the large wire loom using a small flat blade screwdriver. [FIGURE 7]

**FIG.7**



**11.** Remove the large harness from the ECU. Press lock clip and pull up on the grey lever and pulling plug out. [FIGURE 8]

**FIG.8**

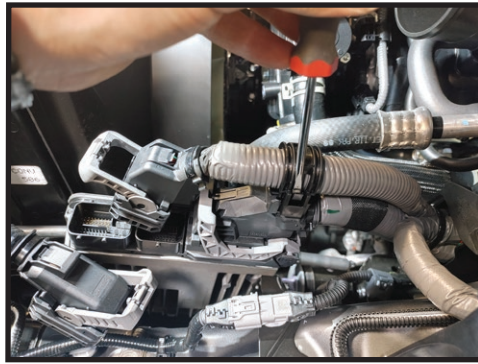

**12.** Remove (3) 10mm bolts from the ECU bracket. One on the front core support, two on the fender well. [FIGURE 9 & 10]

**FIG.9**

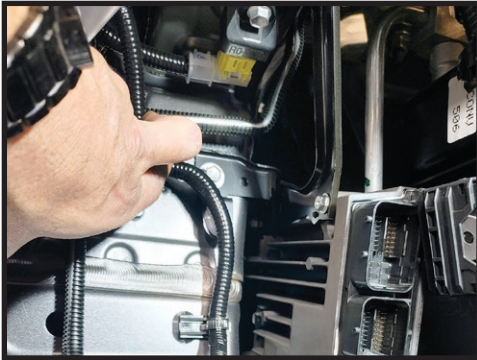

**FIG.10**



**13.** Remove the splash guards from the fender well using a needle nose pliers to pinch the clip and pull out. [FIGURE 11]

**FIG.11**



**14.** Remove the 12mm bolt from the top of the UCA that holds the ABS wire. [FIGURE 12]

**FIG.12**

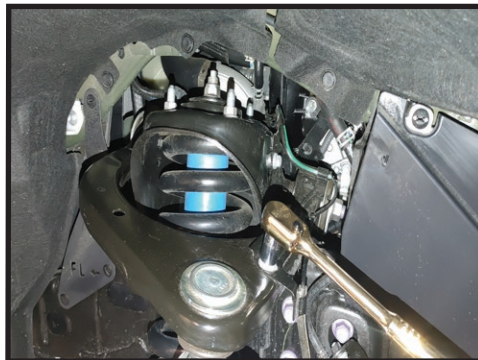

**15.** Remove the cotter pin from the UCA balljoint using a small screwdriver or pick to pry over the safety clip and pull out the pin using a needle nose pliers. Loosen the 19mm nut on the balljoint. [FIGURE 13 & 14]

FIG.13



FIG.14



**16.** Use a hammer or balljoint separator to loosen the balljoint taper from the spindle. [FIGURE 15]

FIG.15



**17.** Loosen and remove the UCA pivot bolt from the frame using a 22mm. [FIGURE 16]

FIG.16



**18.** If installing on a GX550 skip to [Step 20]. Locate the front driver side core support mount bushing. [FIGURE 17]

FIG.17



**19.** Using a jack carefully apply pressure to the driver front core support bolt this will lift the intercooler up enough to remove the UCA pivot bolt. [FIGURE 18 & 19]

FIG.18

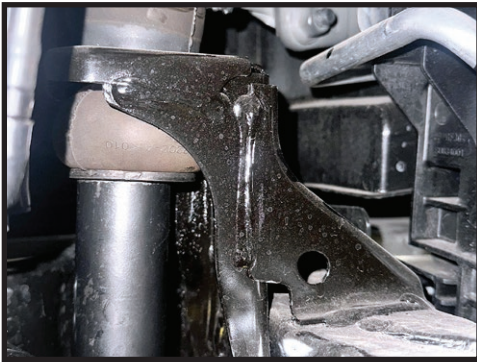
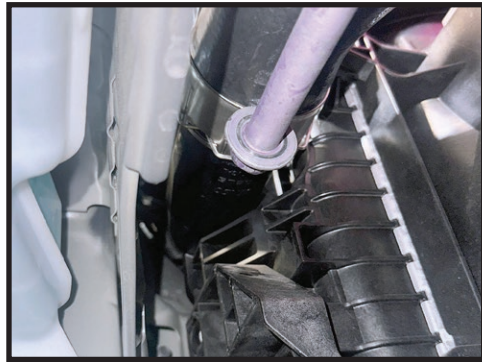

FIG.19



**20.** If installing on a GX550 remove the bolt from the UCA then remove the factory UCA. If installing on a LC250 or Tacoma remove factory UCA. [FIGURE 20]

FIG.20



**21.** Install the new bushings into the ICON tubular UCA as indicated by the drawing below. Grease the ID and OD bushing and the face before install. [FIGURE 21]

FIG.21

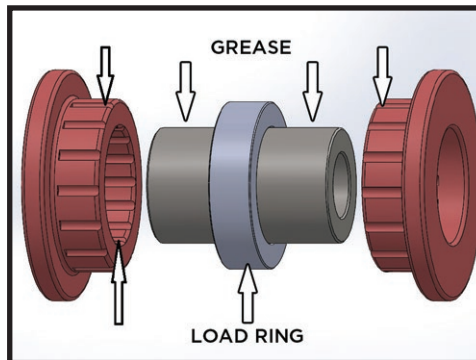

**22.** Install the ICON UCA into position and slide the factory mounting bolt through the heim, spacers and frame. [FIGURE 22 & 23]

FIG.22



FIG.23



**23.** Install the Delta Joint Pro into the spindle, apply included blue thread locker to threads on flange nut and thread on to Delta Joint Pro with washer (PN 605890) between the flange nut and spindle [Torque the nut to 70 ft-lbs]. [FIGURE 24]

FIG.24



**24.** Install the ABS bracket onto the Billet UCA using the factory bolt. [FIGURE 25]

FIG.25



**25.** Torque the factory long pivot bolt to OEM spec.

**26.** Install the supplied delta joint dust cap. [FIGURE 26]

FIG.26

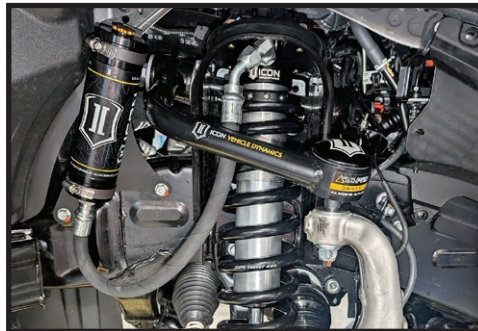

**27.** If installing on a GX550 reinstall the ECU and airbox in reverse order of removal.

**28.** Repeat [Steps 2-15] on passenger side. There is no need for the jack on the core support on the passenger side.

**29.** Reinstall wheels and tires and carefully lower vehicle to the ground. Torque lug nuts to factory spec.

***VERIFY ALL FASTENERS ARE PROPERLY TORQUED BEFORE DRIVING VEHICLE.  
RETORQUE ALL NUTS, BOLTS AND LUGS AFTER 100 MILES AND PERIODICALLY THEREAFTER.***

## ICON VEHICLE DYNAMICS LIMITED LIFETIME WARRANTY

ICON Vehicle Dynamics warrants to the original retail purchaser who owns the vehicle on which the product was originally installed. ICON Vehicle Dynamics does not warrant the product for finish, alterations, modifications and/or installation contrary to ICON Vehicle Dynamics instructions. ICON Vehicle Dynamics products are not designed, nor are they intended to be installed on vehicles used in race applications, for racing purposes or for similar activities. (A "race" is defined as any contest between two or more vehicles, or a contest of one or more vehicles against the clock, whether or not such contest is for a prize). This warranty does not include coverage for police or taxi vehicles, race vehicles, or vehicles used for government or commercial purposes. Also excluded from this warranty are sales outside of the United States of America and Canada.

ICON Vehicle Dynamics' obligation under this warranty is limited to the repair or replacement, at ICON Vehicle Dynamics' discretion, of the defective product. Any and all costs of removal, installation or re-installation, freight charges and incidental or consequential damages are expressly excluded from this warranty. Items that are subject to wear are not considered defective when worn and are not covered.

ICON Vehicle Dynamics components must be installed as a complete kit as shown in our current application guide. Any substitutions or exemptions of required components will immediately void the warranty. Some finish damage may happen to parts during shipping and is not covered under warranty.

This warranty is expressly in lieu of all other warranties expressed or implied. This warranty shall not apply to any product that has been improperly installed, modified or customized subject to accident, negligence, abuse or misuse.



**ICON VEHICLE DYNAMICS®**  
PERFORMANCE SUSPENSION SYSTEMS AND SHOCK ABSORBERS

7929 Lincoln Ave. Riverside, CA 92504 Phone: 951.689.ICON Fax: 951.689.1016  
[www.iconvehicledynamics.com](http://www.iconvehicledynamics.com)



**FOLLOW US ON FACEBOOK!**



7929 Lincoln Ave. Riverside, CA 92504  
 Phone: 951.689.ICON | Fax: 951.689.1016

PART #	DESCRIPTION
58780	24 TACOMA 2.5 VS RR COILOVER KIT

COMPONENTS INCLUDED	
(1) 154602RD 24 TACOMA DRVR 2.5 VS RR CO (1) 154602RP 24 TACOMA PASS 2.5 VS RR CO (1) 611025 HARDWARE KIT	(1) 150143 FRONT DRVR RESI MOUNT (1) 150144 FRONT PASS RESI MOUNT (1) 611051 HOSE CLAMP KIT
HARDWARE INCLUDED	
(4) 605144 3/8-12 X .750 SELF TAP BOLT	(1) 605969 VIBRATITE RED
TOOLS REQUIRED	
JACK JACK STANDS TORQUE WRENCH RATCHET HAMMER BALL JOINT SEPARATOR FLAT BLADE SCREW DRIVER PLIERS, TORQUE WRENCH 9/16 WRENCH AND SOCKET	5/16 NUT DRIVER 10MM SOCKET / WRENCH 12MM SOCKET / WRENCH 14MM SOCKET / WRENCH 19MM SOCKET / WRENCH 22MM SOCKET / WRENCH 24MM SOCKET / WRENCH 35MM SOCKET / WRENCH
TECH NOTES	
<p>1. YOUR ICON COILOVER ASSEMBLIES COME FACTORY CHARGED TO 250 PSI. RELEASING NITROGEN PRESSURE MAY LEAD TO SHOCK MALFUNCTION AND REDUCED RIDE QUALITY. FAILURE CAUSED BY LOW NITROGEN PRESSURE IS NOT COVERED UNDER ICON'S WARRANTY POLICY.</p> <p>2. YOUR ICON COILOVER ASSEMBLIES COME SHIPPED AT ICON'S RECOMMENDED RIDE HEIGHT. REDUCING DROOP TRAVEL WILL REDUCE RIDE QUALITY. DO NOT PRELOAD THE COIL BEYOND 2" OF EXPOSED THREADS BETWEEN THE BOTTOM OF THE TOP CAP AND THE TOP OF THE COIL ADJUSTER NUT. ADJUSTING PRELOAD BEYOND THIS SETTING WILL CAUSE THE COIL TO BIND AND DAMAGE WILL OCCUR TO COILOVER AND/OR VEHICLE.</p> <p>3. 55160 REQUIRED.</p> <p>4. LIFTING OVER 2" REQUIRES ICON UCA.</p> <p>5. ESTIMATED INSTALL TIME: 3 HOURS</p>	



WARNING!
<p>** READ ALL INSTRUCTIONS THOROUGHLY FROM START TO FINISH BEFORE BEGINNING INSTALLATION! IF THESE INSTRUCTIONS ARE NOT PROPERLY FOLLOWED SEVERE FRAME, SUSPENSION AND TIRE DAMAGE MAY RESULT TO THE VEHICLE!</p> <p>** ICON VEHICLE DYNAMICS RECOMMENDS THAT YOU EXERCISE EXTREME CAUTION WHEN WORKING UNDER A VEHICLE THAT IS SUPPORTED WITH JACK STANDS.</p> <p>** ICON VEHICLE DYNAMICS RECOMMENDS ALL INSTALLATION TO BE PERFORMED BY A PROFESSIONAL SHOP/SERVICE TECHNICIAN. PRODUCT FAILURE CAUSED BY IMPROPER INSTALLATION WILL NOT BE COVERED UNDER ICON'S WARRANTY POLICY.</p>

## INSTALLATION

- Place the truck on a flat surface with the parking brake engaged, chock the REAR/FRONT tires.
- Use a suitable floor jack in the manufacturer designated spot on the frame to lift the front of the truck, then place a suitable jack stand under the frame and set the truck down securely on the jack stand. NEVER WORK UNDER AN UNSUPPORTED VEHICLE. Remove the FRONT/REAR wheels and tires.

- Remove sway bar link bolt using a 19mm socket. [FIGURE 1]

FIG.1



4. Remove the two bolts that hold on the brake line and ABS bracket to the knuckle using a 12mm socket. [FIGURE 2 & 3]

FIG.2

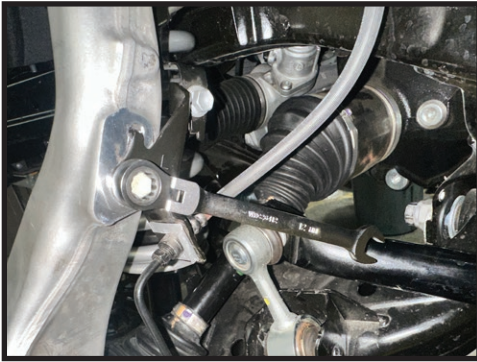

FIG.3



5. Remove the ABS sensor from knuckle using a 10mm socket. [FIGURE 4 & 5]

FIG.4



FIG.5



6. Remove the brake caliper from the spindle using a 19mm. Once removed, use a strap or rope to support the caliper so it does not hang by the brake line. Remove the brake rotor and set aside. [FIGURE 6 & 7]

FIG.6



FIG.7



7. Remove the cotter pin from the tie rod nut using pliers, then remove tie rod nut using 24mm. [FIGURE 8 & 9]

FIG.8



FIG.9



**8.** Use a ball joint separator or a hammer to loosen the tie rod taper. [FIGURE 10]

**FIG.10**



**9.** Remove the hub dust cap using a flat blade screwdriver. [FIGURE 11]

**FIG.11**



**10.** Using a screw driver, pry up the indent in the nut and remove with a 35mm socket. [FIGURE 12 & 13]

**FIG.12**



**FIG.13**



**11.** Using a dead blow hammer, Hit the stub axle to free it from the hub. It will not come out completely yet. [FIGURE 14]

**FIG.14**



**12.** Remove the lower two knuckle bolts using a 22mm socket. [FIGURE 15 & 16]

FIG.15



FIG.16



**13.** Support the CV shaft and remove steering knuckle.

**14.** Support the lower control arm. Using a 14, socket remove the four upper nuts from the factory coilover. [FIGURE 17]

FIG.17

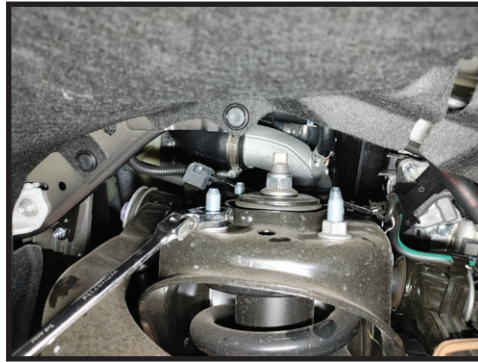

**15.** Remove the lower shock mount using a 22mm socket and wrench. [FIGURE 18 & 19]

FIG.18



FIG.19



**16.** Once the stock coilover is removed, you will need to sand the lower shock mount pocket 3/8" and paint afterwards. [FIGURE 20 & 21]

FIG.20

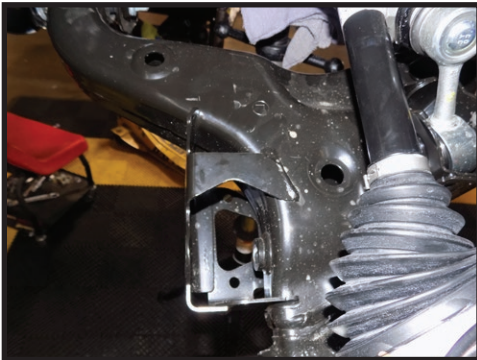
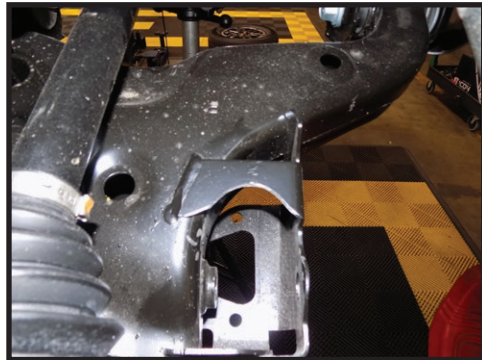

FIG.21



**17.** Install the ICON coilover in the lower arm making sure the shock mount does not hit the shaft spacer. [Torque to factory specs] [FIGURE 22]

FIG.22



**18.** Install the four 3/8 bolt into the upper mount using the washer, lock washer and the supplied thread locker using a 9/16 wrench. Torque to 35 ft-lbs. [FIGURE 23]

FIG.23

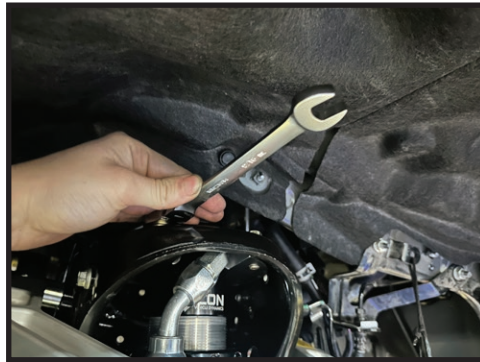

**19.** Remove the factor rubber cover in front of the upper control arm on the frame using the two holes in the frame. Drill them to 11/32. [FIGURE 24 & 25]

FIG.24



FIG.25



**20.** Line up the supplied resi bracket and install the supplied 3/8 self thread screw. [FIGURE 26]

FIG.26



**21.** Use the supplied hose clamps to secure the resi to the bracket. [FIGURE 27, 28 & 29]

FIG.27



FIG.28



FIG.29



**22.** Reinstall spindle, insert the stub axle back into the hub, making sure the splines are aligned. Insert the lower 2 bolts into the spindle. [Torque to factory specs]

**23.** Install tie rod and nut. Torque to factory spec and reinstall cotter pin.

**24.** Install the upper control arm balljoint into the spindle and secure with the nut.

**25.** Torque the lower balljoint bolts to factory spec. Torque the upper balljoint to factory spec if using the OEM arm, or 70 ft-lbs for ICON Delta Joint Pro.

**26.** Install the axle nut and torque to factory spec. Install nut lock plate and cotter pin. Then use a dead blow hammer to install the hub cap.

**27.** Install rotor onto hub and install brake caliper back onto spindle. [Torque bolts to factory spec]

**28.** Reconnect brake line and ABS brackets onto spindle.

**29.** Install ABS sensor back into the spindle and the bracket

**30.** Repeat steps on opposite side.

**31.** Install wheels and tires, lower vehicle to the ground. Torque lug nuts.

**32.** Get vehicle professionally aligned.

***VERIFY ALL FASTENERS ARE PROPERLY TORQUED BEFORE DRIVING VEHICLE.  
RETORQUE ALL NUTS, BOLTS AND LUGS AFTER 100 MILES AND PERIODICALLY THEREAFTER.***

## **ICON VEHICLE DYNAMICS LIMITED LIFETIME WARRANTY**

ICON Vehicle Dynamics warrants to the original retail purchaser who owns the vehicle on which the product was originally installed. ICON Vehicle Dynamics does not warrant the product for finish, alterations, modifications and/or installation contrary to ICON Vehicle Dynamics instructions. ICON Vehicle Dynamics products are not designed, nor are they intended to be installed on vehicles used in race applications, for racing purposes or for similar activities. (A "race" is defined as any contest between two or more vehicles, or a contest of one or more vehicles against the clock, whether or not such contest is for a prize). This warranty does not include coverage for police or taxi vehicles, race vehicles, or vehicles used for government or commercial purposes. Also excluded from this warranty are sales outside of the United States of America and Canada.

ICON Vehicle Dynamics' obligation under this warranty is limited to the repair or replacement, at ICON Vehicle Dynamics' discretion, of the defective product. Any and all costs of removal, installation or re-installation, freight charges and incidental or consequential damages are expressly excluded from this warranty. Items that are subject to wear are not considered defective when worn and are not covered.

ICON Vehicle Dynamics components must be installed as a complete kit as shown in our current application guide. Any substitutions or exemptions of required components will immediately void the warranty. Some finish damage may happen to parts during shipping and is not covered under warranty.

This warranty is expressly in lieu of all other warranties expressed or implied. This warranty shall not apply to any product that has been improperly installed, modified or customized subject to accident, negligence, abuse or misuse.



**ICON VEHICLE DYNAMICS®**  
PERFORMANCE SUSPENSION SYSTEMS AND SHOCK ABSORBERS

7929 Lincoln Ave. Riverside, CA 92504 Phone: 951.689.ICON Fax: 951.689.1016  
[www.iconvehicledynamics.com](http://www.iconvehicledynamics.com)



**FOLLOW US ON FACEBOOK!**

