

7929 Lincoln Ave. Riverside, CA 92504  
Phone: 951.689.ICON Fax: 951.689.1016

PART #	DESCRIPTION
22021	18-UP JEEP JL FRONT LOWER LINK KIT

COMPONENTS INCLUDED	
(2) 124060 18-UP JEEP JL FRONT LOWER LINK	
HARDWARE INCLUDED	
N/A	
TOOLS REQUIRED	
TORQUE WRENCH 15MM SOCKET / WRENCH	21MM SOCKET / WRENCH 24MM SOCKET / WRENCH
TECH NOTES	
1. ICON FRONT LOWER LINKS ARE LONGER THAN FACTORY LINKS AND WILL INCREASE CASTER BEYOND THE FACTORY ALIGNMENT RANGE IF USED AT STOCK RIDE HEIGHT.	



WARNING!
** READ ALL INSTRUCTIONS THOROUGHLY FROM START TO FINISH BEFORE BEGINNING INSTALLATION! IF THESE INSTRUCTIONS ARE NOT PROPERLY FOLLOWED SEVERE FRAME, SUSPENSION AND TIRE DAMAGE MAY RESULT TO THE VEHICLE!
** ICON VEHICLE DYNAMICS RECOMMENDS THAT YOU EXERCISE EXTREME CAUTION WHEN WORKING UNDER A VEHICLE THAT IS SUPPORTED WITH JACK STANDS.
** ICON VEHICLE DYNAMICS RECOMMENDS ALL INSTALLATION TO BE PERFORMED BY A PROFESSIONAL SHOP/SERVICE TECHNICIAN. PRODUCT FAILURE CAUSED BY IMPROPER INSTALLATION WILL NOT BE COVERED UNDER ICON'S WARRANTY POLICY.

## INSTALLATION

1. Place the vehicle on a smooth, level surface. Ensure that the vehicle is in PARK, engage the emergency brake, and chock the tires before performing any work to the vehicle. ICON will not be held liable for any injuries or failure caused by improper installation.

2. Remove the brake line bracket from the front lower links using a 15mm socket/wrench. [FIGURE 1]

FIG.1

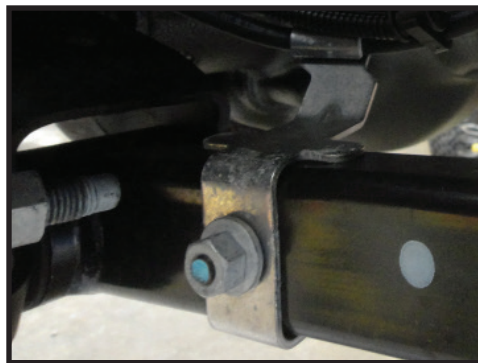

3. Remove the factory front lower link from one side of the vehicle using a 21mm and a 24mm.

4. Install the ICON front lower link using a 21mm and 24mm and the factory hardware. The bend goes to the inside for tire clearance and should be closer to the differential. [Torque to factory spec] [FIGURE 2 & 3]

FIG.2

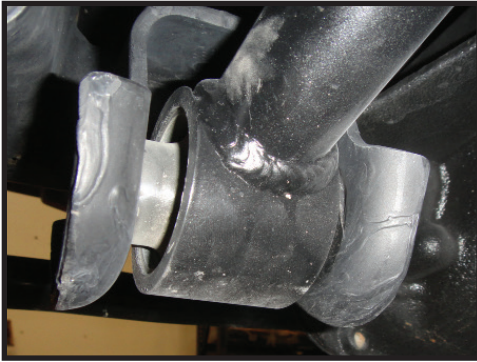

FIG.3



5. Fasten the brake line bracket to the link using the factory hardware. [Torque to factory spec] [FIGURE 4]

FIG.4



6. Repeat steps on the opposite side.

***VERIFY ALL FASTENERS ARE PROPERLY TORQUED BEFORE DRIVING VEHICLE.***

***RETORQUE ALL NUTS, BOLTS AND LUGS AFTER 100 MILES AND PERIODICALLY THEREAFTER.***

## ICON VEHICLE DYNAMICS LIMITED LIFETIME WARRANTY

ICON Vehicle Dynamics warrants to the original retail purchaser who owns the vehicle on which the product was originally installed. ICON Vehicle Dynamics does not warrant the product for finish, alterations, modifications and/or installation contrary to ICON Vehicle Dynamics instructions. ICON Vehicle Dynamics products are not designed, nor are they intended to be installed on vehicles used in race applications, for racing purposes or for similar activities. (A "race" is defined as any contest between two or more vehicles, or a contest of one or more vehicles against the clock, whether or not such contest is for a prize). This warranty does not include coverage for police or taxi vehicles, race vehicles, or vehicles used for government or commercial purposes. Also excluded from this warranty are sales outside of the United States of America and Canada.

ICON Vehicle Dynamics' obligation under this warranty is limited to the repair or replacement, at ICON Vehicle Dynamics' discretion, of the defective product. Any and all costs of removal, installation or re-installation, freight charges and incidental or consequential damages are expressly excluded from this warranty. Items that are subject to wear are not considered defective when worn and are not covered.

ICON Vehicle Dynamics components must be installed as a complete kit as shown in our current application guide. Any substitutions or exemptions of required components will immediately void the warranty. Some finish damage may happen to parts during shipping and is not covered under warranty.

This warranty is expressly in lieu of all other warranties expressed or implied. This warranty shall not apply to any product that has been improperly installed, modified or customized subject to accident, negligence, abuse or misuse.



**ICON VEHICLE DYNAMICS®**  
PERFORMANCE SUSPENSION SYSTEMS AND SHOCK ABSORBERS

7929 Lincoln Ave. Riverside, CA 92504 Phone: 951.689.ICON Fax: 951.689.1016  
[www.iconvehicledynamics.com](http://www.iconvehicledynamics.com)



**FOLLOW US ON FACEBOOK!**



7929 Lincoln Ave. Riverside, CA 92504  
Phone: 951.689.ICON Fax: 951.689.1016

PART #	DESCRIPTION
22022	18-UP JEEP JL FRONT UPPER LINK KIT

COMPONENTS INCLUDED	
(2) 124061 18-UP JEEP JL FRONT UPPER LINK (4) 127006 HEIM SPACER JM12	(2) 295511 JM12T ROD END (2) 605640 3/4-16 JAM NUT
HARDWARE INCLUDED	
N/A	
TOOLS REQUIRED	
TORQUE WRENCH FLATHEAD SCREWDRIVER	10MM SOCKET / WRENCH 18MM SOCKET / WRENCH ADJUSTABLE WRENCH
TECH NOTES	
<p>1. ICON FRONT UPPER LINKS ARE ADJUSTABLE, ALLOWING FOR CHANGES TO BE MADE TO CASTER. DO NOT EXTEND THE ROD END BEYOND 3.375" WHEN MEASURING FROM THE END OF THE TUBE TO THE CENTER OF THE ROD END EYELET.</p>	



WARNING!
<p>** READ ALL INSTRUCTIONS THOROUGHLY FROM START TO FINISH BEFORE BEGINNING INSTALLATION! IF THESE INSTRUCTIONS ARE NOT PROPERLY FOLLOWED SEVERE FRAME, SUSPENSION AND TIRE DAMAGE MAY RESULT TO THE VEHICLE!</p> <p>** ICON VEHICLE DYNAMICS RECOMMENDS THAT YOU EXERCISE EXTREME CAUTION WHEN WORKING UNDER A VEHICLE THAT IS SUPPORTED WITH JACK STANDS.</p> <p>** ICON VEHICLE DYNAMICS RECOMMENDS ALL INSTALLATION TO BE PERFORMED BY A PROFESSIONAL SHOP/SERVICE TECHNICIAN. PRODUCT FAILURE CAUSED BY IMPROPER INSTALLATION WILL NOT BE COVERED UNDER ICON'S WARRANTY POLICY.</p>

## INSTALLATION

1. Place the vehicle on a smooth, level surface. Ensure that the vehicle is in PARK, engage the emergency brake, and chock the tires before performing any work to the vehicle. ICON will not be held liable for any injuries or failure caused by improper installation.

2. Remove the ABS wire connector from the front upper link using a flathead screwdriver. [FIGURE 1]

FIG.1



3. Remove the heat shields from the frame mounts using a 10mm socket/wrench.

4. Remove the driver's side front upper link using two 18mm wrenches.

5. Adjust the link as needed. Do not overextend the link, refer to tech note #1 for maximum adjustment range of the rod end. Once adjusted to desired length, torque the jam nut to 200ft-lbs.

**6.** Install the link on the driver's side using two 18mm wrenches, mount the rod end at the frame pocket and the bushing at the axle. The bend in the link will face downward for engine mount clearance. [Torque to factory spec] [FIGURE 2]

**FIG.2**



**7.** Remount the heat shield using a 10mm socket/wrench. [FIGURE 3]

**FIG.3**



**8.** Reconnect the ABS wire to the link by pressing the plastic connector into the oval hole in the side of the link. [FIGURE 4]

**FIG.4**



**9.** Repeat steps on the opposite side of the vehicle.

***VERIFY ALL FASTENERS ARE PROPERLY TORQUED BEFORE DRIVING VEHICLE.***

***RETORQUE ALL NUTS, BOLTS AND LUGS AFTER 100 MILES AND PERIODICALLY THEREAFTER.***

## ICON VEHICLE DYNAMICS LIMITED LIFETIME WARRANTY

ICON Vehicle Dynamics warrants to the original retail purchaser who owns the vehicle on which the product was originally installed. ICON Vehicle Dynamics does not warrant the product for finish, alterations, modifications and/or installation contrary to ICON Vehicle Dynamics instructions. ICON Vehicle Dynamics products are not designed, nor are they intended to be installed on vehicles used in race applications, for racing purposes or for similar activities. (A "race" is defined as any contest between two or more vehicles, or a contest of one or more vehicles against the clock, whether or not such contest is for a prize). This warranty does not include coverage for police or taxi vehicles, race vehicles, or vehicles used for government or commercial purposes. Also excluded from this warranty are sales outside of the United States of America and Canada.

ICON Vehicle Dynamics' obligation under this warranty is limited to the repair or replacement, at ICON Vehicle Dynamics' discretion, of the defective product. Any and all costs of removal, installation or re-installation, freight charges and incidental or consequential damages are expressly excluded from this warranty. Items that are subject to wear are not considered defective when worn and are not covered.

ICON Vehicle Dynamics components must be installed as a complete kit as shown in our current application guide. Any substitutions or exemptions of required components will immediately void the warranty. Some finish damage may happen to parts during shipping and is not covered under warranty.

This warranty is expressly in lieu of all other warranties expressed or implied. This warranty shall not apply to any product that has been improperly installed, modified or customized subject to accident, negligence, abuse or misuse.



**ICON VEHICLE DYNAMICS®**  
PERFORMANCE SUSPENSION SYSTEMS AND SHOCK ABSORBERS

7929 Lincoln Ave. Riverside, CA 92504 Phone: 951.689.ICON Fax: 951.689.1016  
[www.iconvehicledynamics.com](http://www.iconvehicledynamics.com)



**FOLLOW US ON FACEBOOK!**



7929 Lincoln Ave. Riverside, CA 92504  
Phone: 951.689.ICON | Fax: 951.689.1016

PART #	DESCRIPTION
22025	18-UP JL/20-UP JT 2.5" LIFT FRONT DUAL RATE SPRING KIT

COMPONENTS INCLUDED	
(2) 128503 JL/JT FRONT DUAL RATE SPRING (1) 128005 JL/JT .375" FRONT COIL SHIM	(1) 22025H JL/JT FRONT COIL HARDWARE KIT
HARDWARE INCLUDED	
22025H HARDWARE KIT	
(2) 127200 JL/JT FRONT BUMPSTOP SPACER 1" (2) 605111 3/8-16 X 1.750 FLATHEAD SCREW (2) 605122 3/8-16 C-LOCK NUT	(2) 605133 3/8 FLAT WASHER (2) 605971 BLACK CABLE TIE W/ OVAL TREE
TOOLS REQUIRED	
JACK JACK STANDS TORQUE WRENCH 6MM ALLEN WRENCH	5/32" ALLEN WRENCH 9/16" SOCKET / WRENCH 15MM SOCKET / WRENCH 18MM SOCKET / WRENCH
TECH NOTES	
1. THE SUPPLIED COIL SHIM IS USED TO ACCOUNT FOR THE DIFFERENCE IN HEIGHTS FROM SIDE TO SIDE AND CORRECT A PASSENGER SIDE LEAN.	

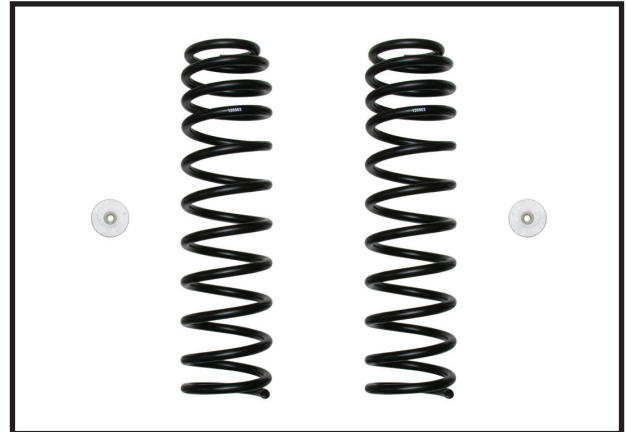

WARNING!
** READ ALL INSTRUCTIONS THOROUGHLY FROM START TO FINISH BEFORE BEGINNING INSTALLATION! IF THESE INSTRUCTIONS ARE NOT PROPERLY FOLLOWED SEVERE FRAME, SUSPENSION AND TIRE DAMAGE MAY RESULT TO THE VEHICLE!
** ICON VEHICLE DYNAMICS RECOMMENDS THAT YOU EXERCISE EXTREME CAUTION WHEN WORKING UNDER A VEHICLE THAT IS SUPPORTED WITH JACK STANDS.
** ICON VEHICLE DYNAMICS RECOMMENDS ALL INSTALLATION TO BE PERFORMED BY A PROFESSIONAL SHOP/SERVICE TECHNICIAN. PRODUCT FAILURE CAUSED BY IMPROPER INSTALLATION WILL NOT BE COVERED UNDER ICON'S WARRANTY POLICY.

## INSTALLATION

- Using a properly rated jack, raise the front of the vehicle and support the frame rails with jack stands. Ensure the jack stands are secure and set properly before lowering the jack. NEVER WORK UNDER AN UNSUPPORTED VEHICLE. Remove the front wheels.
- Remove the sway bar links from the axle using (2) 18mm wrenches. Remove the front sway bar links from the sway bar using a 6mm allen wrench and an 18mm. [FIGURE 1]

FIG.1



FIG.2

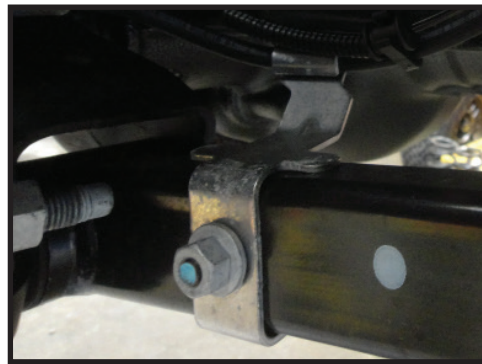

- Remove the nut from the brake line bracket, then slide the bracket off of the stud on the lower link using a 15mm. Slide the brake line in the bracket to gain some extra slack. [FIGURE 2]

4. Remove the nut from the front lower shock mount using an 18mm. [FIGURE 3]

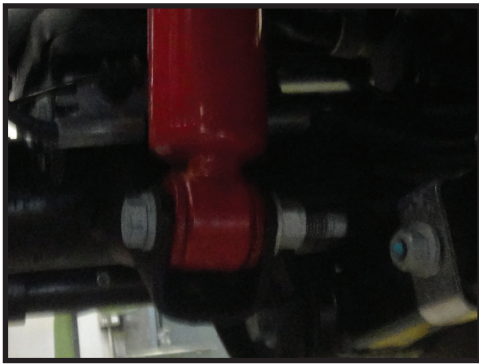

FIG.3

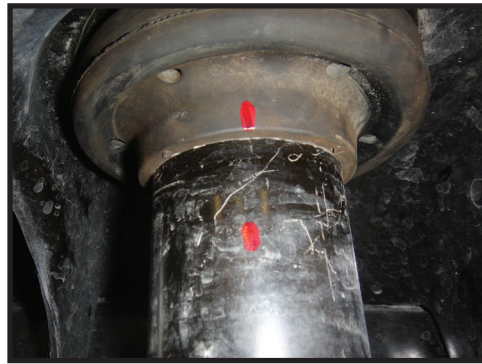

FIG.4

5. Support the axle with a jack to remove the tension from the lower shock mount and remove the factory shock bolt. **RUBICON ONLY\*** Disconnect the front locker plug from the differential and remove the clip from the upper link arm.

6. With a marker, make a line on the coil isolator and coil bucket to indicate isolator clocking. Carefully lower the front axle until the coil springs can be removed. Use caution to not overextend any brake or ABS lines when lowering the axle. [FIGURE 4]

7. Remove the front coil springs. Make sure the upper and lower coil isolators are still in place with locating prongs in holes on driver's side. Remove locating pins from passenger side isolator to install supplied shim. Install the supplied (128005) coil shim between the upper isolator and coil bucket on the passenger side. Remove tip from the factory coil isolator so that the shim can be installed.

8. Install the (128503) coil springs, taking care to seat the coil properly in the upper and lower isolators as well as align the mark made in step 6 on passenger side. It will be necessary to lower the front axle further to install the new coils. Be careful to not damage any lines when lowering the axle. Verify that the coil springs are properly oriented.

9. With the new coil springs installed, lift the axle enough to install the longer shocks using the factory hardware and an 18mm. [Torque to factory spec] [FIGURE 5]

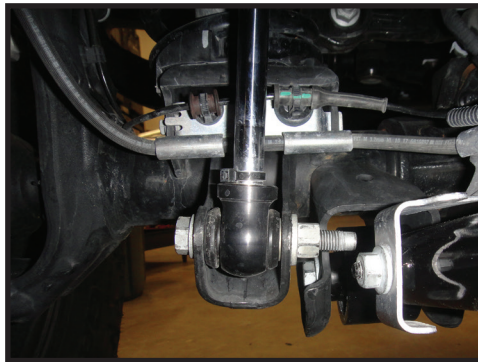

FIG.5

10. Slide the brake line in the steel bracket to gain extra slack with the suspension fully extended. Connect the brake line bracket to the front lower link using the factory nut and a 15mm. [Torque to factory spec]

11. Slide the bump stop spacer through the coil spring. Make sure that the spacer is centered on the striker pad. Fasten the bump stop spacer to the striker pad using the supplied 3/8" hardware. On the passenger side, the nut is hard to reach. It is helpful to remove the brake line bracket from the back side of the coil spring mount using a 10mm. [Torque to 30 ft-lbs] [FIGURE 6]



FIG.6

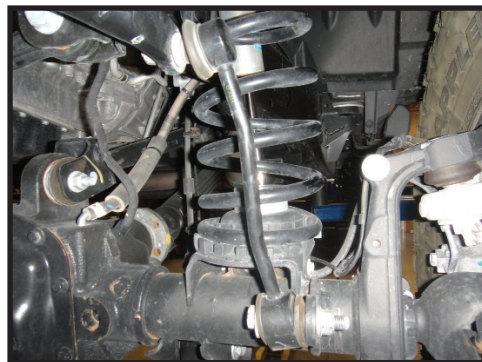

FIG.7

12. **\*\*\*WRANGLER JL ONLY\*\*\*** Mount the factory rear sway bar links (to the front axle housing) using factory hardware and a 6mm allen wrench and an 18mm. [Torque to factory spec] [FIGURE 7] **RUBICON ONLY\*** Use the supplied oval tree cable ties to allow extra slack for the front differential locker wiring harness at full suspension extension.

**NOTE: \*\*\*WRANGLER JL ONLY\*\*\*** ICON supplies longer rear sway bar links with the rear coil spring kit (22026).

13. Install the wheels and lower the vehicle back to the ground. [Torque lugs to factory spec]

**VERIFY ALL FASTENERS ARE PROPERLY TORQUED BEFORE DRIVING VEHICLE.**

**RETORQUE ALL NUTS, BOLTS AND LUGS AFTER 100 MILES AND PERIODICALLY THEREAFTER.**

### **ICON VEHICLE DYNAMICS LIMITED LIFETIME WARRANTY**

ICON Vehicle Dynamics warrants to the original retail purchaser who owns the vehicle on which the product was originally installed. ICON Vehicle Dynamics does not warrant the product for finish, alterations, modifications and/or installation contrary to ICON Vehicle Dynamics instructions. ICON Vehicle Dynamics products are not designed, nor are they intended to be installed on vehicles used in race applications, for racing purposes or for similar activities. (A "race" is defined as any contest between two or more vehicles, or a contest of one or more vehicles against the clock, whether or not such contest is for a prize). This warranty does not include coverage for police or taxi vehicles, race vehicles, or vehicles used for government or commercial purposes. Also excluded from this warranty are sales outside of the United States of America and Canada.

ICON Vehicle Dynamics' obligation under this warranty is limited to the repair or replacement, at ICON Vehicle Dynamics' discretion, of the defective product. Any and all costs of removal, installation or re-installation, freight charges and incidental or consequential damages are expressly excluded from this warranty. Items that are subject to wear are not considered defective when worn and are not covered.

ICON Vehicle Dynamics components must be installed as a complete kit as shown in our current application guide. Any substitutions or exemptions of required components will immediately void the warranty. Some finish damage may happen to parts during shipping and is not covered under warranty.

This warranty is expressly in lieu of all other warranties expressed or implied. This warranty shall not apply to any product that has been improperly installed, modified or customized subject to accident, negligence, abuse or misuse.



**ICON VEHICLE DYNAMICS®**  
PERFORMANCE SUSPENSION SYSTEMS AND SHOCK ABSORBERS

7929 Lincoln Ave. Riverside, CA 92504 Phone: 951.689.ICON Fax: 951.689.1016  
[www.iconvehicledynamics.com](http://www.iconvehicledynamics.com)



**FOLLOW US ON FACEBOOK!**



7929 Lincoln Ave. Riverside, CA 92504  
Phone: 951.689.ICON Fax: 951.689.1016

PART #	DESCRIPTION
22027	18-UP JEEP JL FRONT ADJUSTABLE TRACK BAR KIT

COMPONENTS INCLUDED	
(1) 124064 18-UP JL FRONT TRACK BAR (1) 157520 LEFT/RIGHT ADJUSTER SLEEVE (2) 217200 HEIM SPACER RSXM12	(1) 295511 JM12T ROD END (2) 605147 12 PT FLANGED SCREW
HARDWARE INCLUDED	
N/A	
TOOLS REQUIRED	
1/4" PIN WRENCH (SPANNER) TORQUE WRENCH	3/8" 12PT SOCKET / WRENCH 21MM SOCKET / WRENCH
TECH NOTES	
<p>1. FAILURE TO CENTER STEERING WHEEL AFTER INSTALLATION WILL LEAD TO STABILITY/TRACTION CONTROL ISSUES.</p> <p>2. AFTER INSTALLATION IS COMPLETE, HAVE THE VEHICLE PROFESSIONALLY ALIGNED.</p> <p>3. DO NOT EXCEED 2.00" ADJUSTMENT FROM THE CENTER OF THE ROD END TO THE EDGE OF THE TRACK BAR PINCH HOUSING. FAILURE CAUSED BY EXCESSIVE ADJUSTMENT WILL NOT BE COVERED UNDER ICON'S WARRANTY POLICY.</p>	

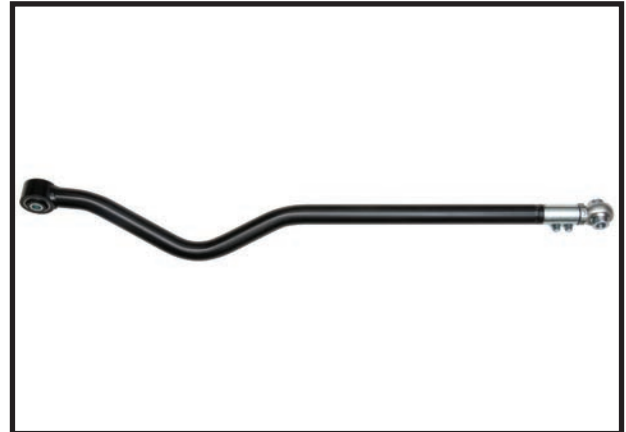

WARNING!
<p>** READ ALL INSTRUCTIONS THOROUGHLY FROM START TO FINISH BEFORE BEGINNING INSTALLATION! IF THESE INSTRUCTIONS ARE NOT PROPERLY FOLLOWED SEVERE FRAME, SUSPENSION AND TIRE DAMAGE MAY RESULT TO THE VEHICLE!</p> <p>** ICON VEHICLE DYNAMICS RECOMMENDS THAT YOU EXERCISE EXTREME CAUTION WHEN WORKING UNDER A VEHICLE THAT IS SUPPORTED WITH JACK STANDS.</p> <p>** ICON VEHICLE DYNAMICS RECOMMENDS ALL INSTALLATION TO BE PERFORMED BY A PROFESSIONAL SHOP/SERVICE TECHNICIAN. PRODUCT FAILURE CAUSED BY IMPROPER INSTALLATION WILL NOT BE COVERED UNDER ICON'S WARRANTY POLICY.</p>

## INSTALLATION

- Place the vehicle on a smooth, level surface. Ensure that the vehicle is in PARK, engage the emergency brake, and chock the tires before performing any work to the vehicle. ICON will not be held liable for any injuries or failure caused by improper installation.
- With the vehicle on the ground, remove the front track bar using a 21mm socket/wrench. [FIGURE 1]

FIG.1



FIG.2



- Install the ICON track bar using the factory hardware and a 21mm socket/wrench. [Torque to factory spec] [FIGURE 2]
- Ensure pinch bolts are loose before adjusting the length of the track bar. Center the front axle under the frame using a pin wrench. Once centered, align the slit in the adjuster sleeve with the slit in the track bar. Torque pinch bolts to 35 ft-lbs, alternating between both sides using a 3/8" 12pt.
- Adjust the drag link to center the steering wheel. Failure to center the steering wheel after installation will lead to stability/traction control issues.
- Have the vehicle professionally aligned.

**VERIFY ALL FASTENERS ARE PROPERLY TORQUED BEFORE DRIVING VEHICLE.**

**RETORQUE ALL NUTS, BOLTS AND LUGS AFTER 100 MILES AND PERIODICALLY THEREAFTER.**

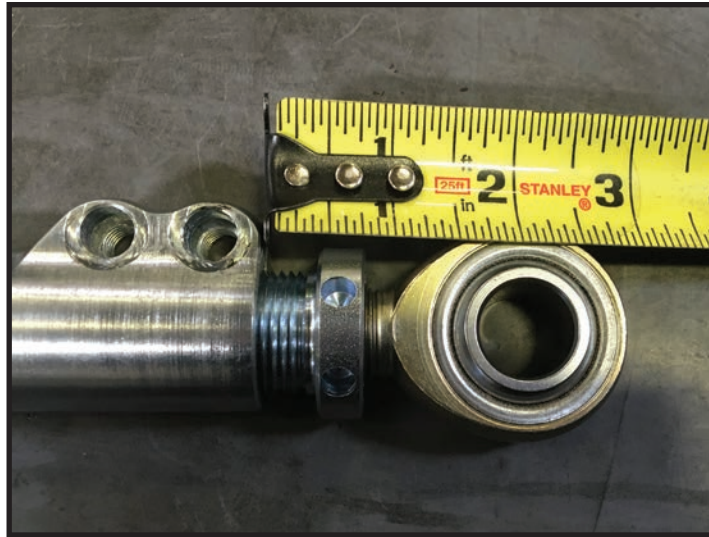

### **ICON VEHICLE DYNAMICS LIMITED LIFETIME WARRANTY**

ICON Vehicle Dynamics warrants to the original retail purchaser who owns the vehicle on which the product was originally installed. ICON Vehicle Dynamics does not warrant the product for finish, alterations, modifications and/or installation contrary to ICON Vehicle Dynamics instructions. ICON Vehicle Dynamics products are not designed, nor are they intended to be installed on vehicles used in race applications, for racing purposes or for similar activities. (A "race" is defined as any contest between two or more vehicles, or a contest of one or more vehicles against the clock, whether or not such contest is for a prize). This warranty does not include coverage for police or taxi vehicles, race vehicles, or vehicles used for government or commercial purposes. Also excluded from this warranty are sales outside of the United States of America and Canada.

ICON Vehicle Dynamics' obligation under this warranty is limited to the repair or replacement, at ICON Vehicle Dynamics' discretion, of the defective product. Any and all costs of removal, installation or re-installation, freight charges and incidental or consequential damages are expressly excluded from this warranty. Items that are subject to wear are not considered defective when worn and are not covered.

ICON Vehicle Dynamics components must be installed as a complete kit as shown in our current application guide. Any substitutions or exemptions of required components will immediately void the warranty. Some finish damage may happen to parts during shipping and is not covered under warranty.

This warranty is expressly in lieu of all other warranties expressed or implied. This warranty shall not apply to any product that has been improperly installed, modified or customized subject to accident, negligence, abuse or misuse.



**ICON VEHICLE DYNAMICS®**  
PERFORMANCE SUSPENSION SYSTEMS AND SHOCK ABSORBERS

7929 Lincoln Ave. Riverside, CA 92504 Phone: 951.689.ICON Fax: 951.689.1016  
[www.iconvehicledynamics.com](http://www.iconvehicledynamics.com)



**FOLLOW US ON FACEBOOK!**



7929 Lincoln Ave. Riverside, CA 92504  
 Phone: 951.689.ICON | Fax: 951.689.1016

PART #	DESCRIPTION
22061	18-UP JL/20-UP JT FRONT SWAY BAR LINK KIT

COMPONENTS INCLUDED	
(2) 197031 3/4" HEX BAR END LINK 6.25" LONG	
HARDWARE INCLUDED	
(2) 127212 JL/JT SWAY BAR END LINK SPACER (1) 295503 ROD END 1/2-20 RIGHT HAND SHANK AND STUD (2) 295504 ROD END 1/2-20 LEFT HAND SHANK RIGHT HAND STUD (1) 295512 ROD END 1/2-20 RIGHT HAND SHANK	(6) 605330 1/2" FLAT WASHER (3) 605350 1/2-20 C-LOCK NUT (2) 605355 1/2-20 JAM NUT THIN (2) 605356 1/2-20 JAM NUT THIN LEFT HAND
TOOLS REQUIRED	
DRILL 1/2" DRILL BIT TORQUE WRENCH	5/8" SOCKET / WRENCH 3/4" SOCKET / WRENCH 18MM SOCKET / WRENCH
TECH NOTES	
END LINK MAX ALLOWABLE ADJUSTMENT FORM CENTER OF ROD END TO CENTER OF ROD END IS 9.75"	

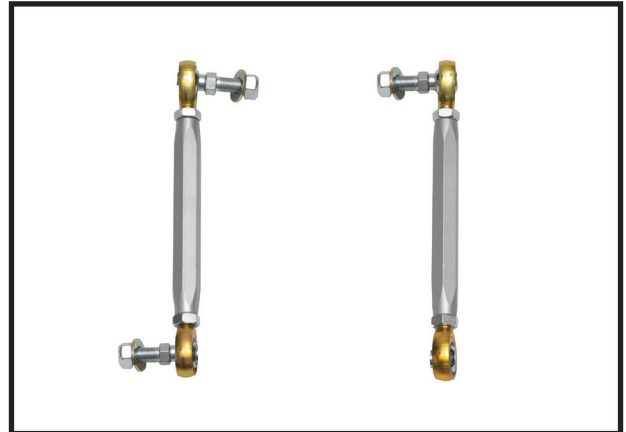

**WARNING!**

**\*\* READ ALL INSTRUCTIONS THOROUGHLY FROM START TO FINISH BEFORE BEGINNING INSTALLATION! IF THESE INSTRUCTIONS ARE NOT PROPERLY FOLLOWED SEVERE FRAME, SUSPENSION AND TIRE DAMAGE MAY RESULT TO THE VEHICLE!**

**\*\* ICON VEHICLE DYNAMICS RECOMMENDS THAT YOU EXERCISE EXTREME CAUTION WHEN WORKING UNDER A VEHICLE THAT IS SUPPORTED WITH JACK STANDS.**

**\*\* ICON VEHICLE DYNAMICS RECOMMENDS ALL INSTALLATION TO BE PERFORMED BY A PROFESSIONAL SHOP/SERVICE TECHNICIAN. PRODUCT FAILURE CAUSED BY IMPROPER INSTALLATION WILL NOT BE COVERED UNDER ICON'S WARRANTY POLICY.**

## INSTALLATION

- Using a properly rated jack, raise the front of the vehicle and support the frame rails with jack stands. Ensure the jack stands are secure and set properly before lowering the jack. NEVER WORK UNDER AN UNSUPPORTED VEHICLE. Remove the front wheels.
- Remove the factory sway bar links using an 18mm. [FIGURE 1]

FIG.1



FIG.2



- Using a 1/2" drill bit, carefully drill out the sway bar hole. [FIGURE 2]
- The sway bar links come preassembled by ICON, verify that the studs are in the proper orientation before mounting.

5. Mount the sway bar link with the open eyelet on the passenger side using the supplied spacers with the factory bolt and an 18mm socket/wrench. [Torque to factory spec] Mount the stud of the rod end to the sway bar using 1/2" washers on both sides with a 5/8" and 3/4" socket/wrench. [Torque nut to 50 ft-lbs] [FIGURE 3]

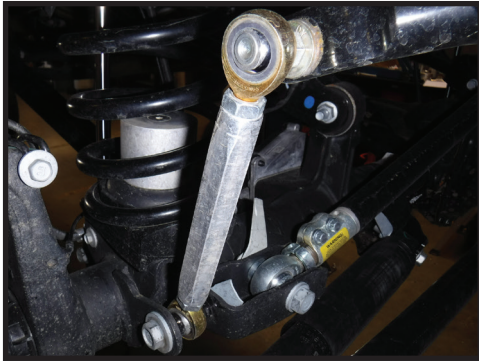

FIG.3



FIG.4

6. Mount the other sway bar link on driver side using 1/2" washers on both sides with a 5/8" and 3/4" socket/wrench. [Torque nut to 50 ft-lbs] [FIGURE 4]

7. Keep rod ends parallel and tighten jam nuts using a 3/4" wrench.

**VERIFY ALL FASTENERS ARE PROPERLY TORQUED BEFORE DRIVING VEHICLE.**

**RETORQUE ALL NUTS, BOLTS AND LUGS AFTER 100 MILES AND PERIODICALLY THEREAFTER.**

### **ICON VEHICLE DYNAMICS LIMITED LIFETIME WARRANTY**

ICON Vehicle Dynamics warrants to the original retail purchaser who owns the vehicle on which the product was originally installed. ICON Vehicle Dynamics does not warrant the product for finish, alterations, modifications and/or installation contrary to ICON Vehicle Dynamics instructions. ICON Vehicle Dynamics products are not designed, nor are they intended to be installed on vehicles used in race applications, for racing purposes or for similar activities. (A "race" is defined as any contest between two or more vehicles, or a contest of one or more vehicles against the clock, whether or not such contest is for a prize). This warranty does not include coverage for police or taxi vehicles, race vehicles, or vehicles used for government or commercial purposes. Also excluded from this warranty are sales outside of the United States of America and Canada.

ICON Vehicle Dynamics' obligation under this warranty is limited to the repair or replacement, at ICON Vehicle Dynamics' discretion, of the defective product. Any and all costs of removal, installation or re-installation, freight charges and incidental or consequential damages are expressly excluded from this warranty. Items that are subject to wear are not considered defective when worn and are not covered.

ICON Vehicle Dynamics components must be installed as a complete kit as shown in our current application guide. Any substitutions or exemptions of required components will immediately void the warranty. Some finish damage may happen to parts during shipping and is not covered under warranty.

This warranty is expressly in lieu of all other warranties expressed or implied. This warranty shall not apply to any product that has been improperly installed, modified or customized subject to accident, negligence, abuse or misuse.



**ICON VEHICLE DYNAMICS®**  
PERFORMANCE SUSPENSION SYSTEMS AND SHOCK ABSORBERS

7929 Lincoln Ave. Riverside, CA 92504 Phone: 951.689.ICON Fax: 951.689.1016  
[www.iconvehicledynamics.com](http://www.iconvehicledynamics.com)



**FOLLOW US ON FACEBOOK!**



7929 Lincoln Ave. Riverside, CA 92504  
Phone: 951.689.ICON | Fax: 951.689.1016

PART #	DESCRIPTION
22063	20-UP JT BILLET REAR LOWER LINK KIT

COMPONENTS INCLUDED	
(2) 127204 20-UP JT BILLET LOWER REAR TRAILING ARM (2) 127205 20-UP JT TRAILING ARM WEAR STRIP (4) 127206 HEIM SPACER 1.000 X .630 X 2.625 (2) 157420 NUT PLATE 3/8-16 X 2	(2) 167014 L/R ADJUSTING SLEEVE 1.25-12L / 1.00-14 (2) 295510 JM161T, 1-14 RH ROD END (2) 297108 GREASLESS BUSHING 2.135 X 16.2MM X 66.5MM
HARDWARE INCLUDED	
(14) 605018 10-32 X .438 FLAT HEAD SCREW	(4) 605146 3/8-16 X 1.50 12PT BOLT
TOOLS REQUIRED	
JACK JACK STANDS TORQUE WRENCH 21MM SOCKET / WRENCH	24MM SOCKET / WRENCH 3/8" 12PT SOCKET / WRENCH ADJUSTABLE WRENCH
TECH NOTES	
<p>1. DO NOT EXCEED 3.375" ADJUSTMENT FROM THE CENTER OF THE ROD END TO THE EDGE OF THE BILLET LINK. FAILURE CAUSED BY EXCESSIVE ADJUSTMENT WILL NOT BE COVERED UNDER ICON'S WARRANTY POLICY.</p> <p>2. LINKS ARE PRESET TO 23.75" EYE TO EYE (STOCK LINKS ARE 23.75")</p> <p>3. IF CUSTOM PINION ANGLE IS DESIRED YOU CAN ADJUST THIS WITH THE VEHICLE ON THE GROUND.</p>	



WARNING!
<p>** READ ALL INSTRUCTIONS THOROUGHLY FROM START TO FINISH BEFORE BEGINNING INSTALLATION! IF THESE INSTRUCTIONS ARE NOT PROPERLY FOLLOWED SEVERE FRAME, SUSPENSION AND TIRE DAMAGE MAY RESULT TO THE VEHICLE!</p> <p>** ICON VEHICLE DYNAMICS RECOMMENDS THAT YOU EXERCISE EXTREME CAUTION WHEN WORKING UNDER A VEHICLE THAT IS SUPPORTED WITH JACK STANDS.</p> <p>** ICON VEHICLE DYNAMICS RECOMMENDS ALL INSTALLATION TO BE PERFORMED BY A PROFESSIONAL SHOP/SERVICE TECHNICIAN. PRODUCT FAILURE CAUSED BY IMPROPER INSTALLATION WILL NOT BE COVERED UNDER ICON'S WARRANTY POLICY.</p>

## INSTALLATION

1. Place the vehicle on a smooth, level surface. Ensure that the vehicle is in PARK, engage the emergency brake, and chock the tires before performing any work to the vehicle. ICON will not be held liable for any injuries or failure caused by improper installation.
2. Remove the driver side rear lower link using a 21mm and 24mm. [FIGURE 1 & 2]

FIG.1



FIG.2



**3.** Mount the rod end to the frame using factory hardware. Pinch bolts should be facing out. Mount the bushing side of the link to the differential using factory hardware. Torque bolts to factory spec using a 21mm and 24mm. [FIGURE 3 & 4]

FIG.3



FIG.4



**4.** Repeat steps on opposite side of vehicle.

**5.** To adjust, loosen the pinch bolts billet link using a 3/8 12pt. Turn the L/R adjusting collar until desired length is reached.

**6.** Make sure that the slit in the collar is lined up with the slit in the pinch housing and tighten pinch bolts using an alternating pattern [Torque to 40 ft-lbs]. Go back and forth between bolts 3 times to torque equally.

**7.** Never exceed the maximum length as listed in the tech notes.

[TECH NOTE #1]

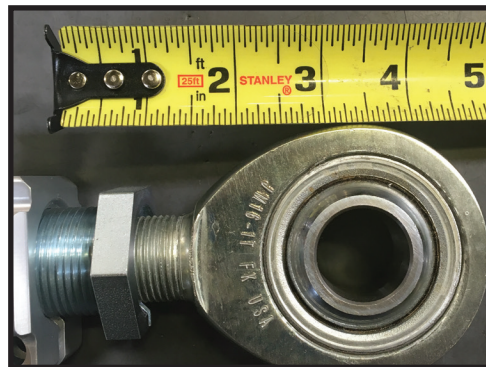

***VERIFY ALL FASTENERS ARE PROPERLY TORQUED BEFORE DRIVING VEHICLE.***

***RETORQUE ALL NUTS, BOLTS AND LUGS AFTER 100 MILES AND PERIODICALLY THEREAFTER.***

## ICON VEHICLE DYNAMICS LIMITED LIFETIME WARRANTY

ICON Vehicle Dynamics warrants to the original retail purchaser who owns the vehicle on which the product was originally installed. ICON Vehicle Dynamics does not warrant the product for finish, alterations, modifications and/or installation contrary to ICON Vehicle Dynamics instructions. ICON Vehicle Dynamics products are not designed, nor are they intended to be installed on vehicles used in race applications, for racing purposes or for similar activities. (A "race" is defined as any contest between two or more vehicles, or a contest of one or more vehicles against the clock, whether or not such contest is for a prize). This warranty does not include coverage for police or taxi vehicles, race vehicles, or vehicles used for government or commercial purposes. Also excluded from this warranty are sales outside of the United States of America and Canada.

ICON Vehicle Dynamics' obligation under this warranty is limited to the repair or replacement, at ICON Vehicle Dynamics' discretion, of the defective product. Any and all costs of removal, installation or re-installation, freight charges and incidental or consequential damages are expressly excluded from this warranty. Items that are subject to wear are not considered defective when worn and are not covered.

ICON Vehicle Dynamics components must be installed as a complete kit as shown in our current application guide. Any substitutions or exemptions of required components will immediately void the warranty. Some finish damage may happen to parts during shipping and is not covered under warranty.

This warranty is expressly in lieu of all other warranties expressed or implied. This warranty shall not apply to any product that has been improperly installed, modified or customized subject to accident, negligence, abuse or misuse.



**ICON VEHICLE DYNAMICS®**  
PERFORMANCE SUSPENSION SYSTEMS AND SHOCK ABSORBERS

7929 Lincoln Ave. Riverside, CA 92504 Phone: 951.689.ICON Fax: 951.689.1016  
[www.iconvehicledynamics.com](http://www.iconvehicledynamics.com)



**FOLLOW US ON FACEBOOK!**



7929 Lincoln Ave. Riverside, CA 92504  
Phone: 951.689.ICON | Fax: 951.689.1016

PART #	DESCRIPTION
22064	20-UP JT BILLET REAR UPPER LINK KIT

COMPONENTS INCLUDED	
(2) 127203 20-UP JT BILLET UPPER REAR TRAILING ARM (4) 127206 HEIM SPACER 1.000 X .630 X 2.625 (2) 167014 L/R ADJUSTING SLEEVE 1.25-12L / 1.00-14	(2) 295510 JM161T, 1-14 RH ROD END (2) 297108 GREASLESS BUSHING 2.135 X 16.2MM X 66.5MM
HARDWARE INCLUDED	
(2) 157420 NUT PLATE 3/8-16 X 2	(4) 605146 3/8-16 X 1.50 12PT BOLT
TOOLS REQUIRED	
JACK JACK STANDS TORQUE WRENCH 21MM SOCKET / WRENCH	24MM SOCKET / WRENCH 3/8"-12PT SOCKET / WRENCH ADJUSTABLE WRENCH
TECH NOTES	
<p>1. DO NOT EXCEED 3.375" ADJUSTMENT FROM THE CENTER OF THE ROD END TO THE EDGE OF THE BILLET LINK. FAILURE CAUSED BY EXCESSIVE ADJUSTMENT WILL NOT BE COVERED UNDER ICON'S WARRANTY POLICY.</p> <p>2. LINKS ARE PRESET TO 16.5" EYE TO EYE (STOCK LINKS ARE 16.3").</p> <p>3. IF CUSTOM PINION ANGLE IS DESIRED YOU CAN ADJUST THIS WITH THE VEHICLE ON THE GROUND.</p>	



WARNING!
<p>** READ ALL INSTRUCTIONS THOROUGHLY FROM START TO FINISH BEFORE BEGINNING INSTALLATION! IF THESE INSTRUCTIONS ARE NOT PROPERLY FOLLOWED SEVERE FRAME, SUSPENSION AND TIRE DAMAGE MAY RESULT TO THE VEHICLE!</p> <p>** ICON VEHICLE DYNAMICS RECOMMENDS THAT YOU EXERCISE EXTREME CAUTION WHEN WORKING UNDER A VEHICLE THAT IS SUPPORTED WITH JACK STANDS.</p> <p>** ICON VEHICLE DYNAMICS RECOMMENDS ALL INSTALLATION TO BE PERFORMED BY A PROFESSIONAL SHOP/SERVICE TECHNICIAN. PRODUCT FAILURE CAUSED BY IMPROPER INSTALLATION WILL NOT BE COVERED UNDER ICON'S WARRANTY POLICY.</p>

## INSTALLATION

1. Place the vehicle on a smooth, level surface. Ensure that the vehicle is in PARK, engage the emergency brake, and chock the tires before performing any work to the vehicle. ICON will not be held liable for any injuries or failure caused by improper installation.
2. Remove the driver side rear upper link using a 21mm and 24mm. [FIGURE 1 & 2]

FIG.1



FIG.2



**3.** Mount the rod end to the differential using factory hardware. Pinch bolts should be facing out. Mount the bushing side of the link to the frame using factory hardware. Torque bolts to factory spec using a 21mm and 24mm. [FIGURE 3 & 4]

FIG.3



FIG.4



**4.** Repeat steps on opposite side of vehicle.

**5.** To adjust, loosen the pinch bolts billet link using a 3/8" 12pt. Turn the L/R adjusting collar until desired length is reached.

**6.** Make sure that the slit in the collar is lined up with the slit in the pinch housing and tighten pinch bolts using an alternating pattern [Torque to 40 ft-lbs]. Go back and forth between bolts 3 times to torque equally.

**7.** Never exceed the maximum length as listed in the tech notes.

[TECH NOTE #1]

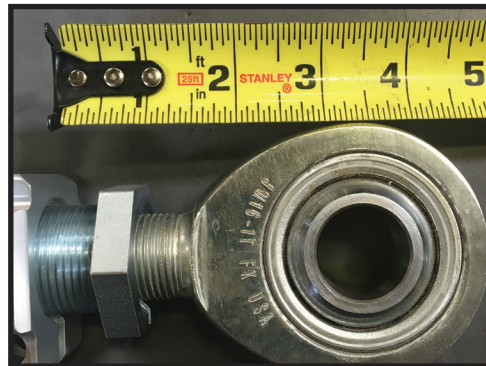

***VERIFY ALL FASTENERS ARE PROPERLY TORQUED BEFORE DRIVING VEHICLE.***

***RETORQUE ALL NUTS, BOLTS AND LUGS AFTER 100 MILES AND PERIODICALLY THEREAFTER.***

## ICON VEHICLE DYNAMICS LIMITED LIFETIME WARRANTY

ICON Vehicle Dynamics warrants to the original retail purchaser who owns the vehicle on which the product was originally installed. ICON Vehicle Dynamics does not warrant the product for finish, alterations, modifications and/or installation contrary to ICON Vehicle Dynamics instructions. ICON Vehicle Dynamics products are not designed, nor are they intended to be installed on vehicles used in race applications, for racing purposes or for similar activities. (A "race" is defined as any contest between two or more vehicles, or a contest of one or more vehicles against the clock, whether or not such contest is for a prize). This warranty does not include coverage for police or taxi vehicles, race vehicles, or vehicles used for government or commercial purposes. Also excluded from this warranty are sales outside of the United States of America and Canada.

ICON Vehicle Dynamics' obligation under this warranty is limited to the repair or replacement, at ICON Vehicle Dynamics' discretion, of the defective product. Any and all costs of removal, installation or re-installation, freight charges and incidental or consequential damages are expressly excluded from this warranty. Items that are subject to wear are not considered defective when worn and are not covered.

ICON Vehicle Dynamics components must be installed as a complete kit as shown in our current application guide. Any substitutions or exemptions of required components will immediately void the warranty. Some finish damage may happen to parts during shipping and is not covered under warranty.

This warranty is expressly in lieu of all other warranties expressed or implied. This warranty shall not apply to any product that has been improperly installed, modified or customized subject to accident, negligence, abuse or misuse.



**ICON VEHICLE DYNAMICS®**  
PERFORMANCE SUSPENSION SYSTEMS AND SHOCK ABSORBERS

7929 Lincoln Ave. Riverside, CA 92504 Phone: 951.689.ICON Fax: 951.689.1016  
[www.iconvehicledynamics.com](http://www.iconvehicledynamics.com)



**FOLLOW US ON FACEBOOK!**



7929 Lincoln Ave. Riverside, CA 92504  
Phone: 951.689.ICON | Fax: 951.689.1016

PART #	DESCRIPTION
22066	20-UP JT 1.5" MULTI-RATE SPRING KIT

COMPONENTS INCLUDED	
(2) 128523 20+ JT REAR 1.5" TRIPLE RATE COIL SPRING	
HARDWARE INCLUDED	
N/A	
TOOLS REQUIRED	
JACK JACK STANDS TORQUE WRENCH	10MM SOCKET / WRENCH 18MM SOCKET / WRENCH 21MM SOCKET / WRENCH
TECH NOTES	
<p>1. INTENDED FOR USE WITH ICON SHOCKS.</p> <p>2. REQUIRES: SWAY BAR RELOCATION KIT (PN 22062) OR SWAY BAR LINK KIT (PN 22070).</p>	

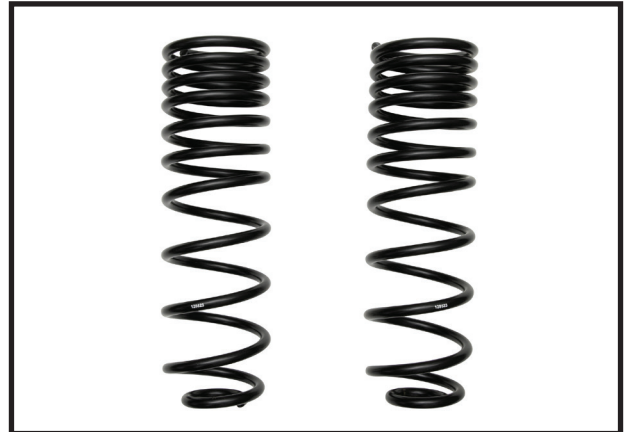

WARNING!
<p><b>** READ ALL INSTRUCTIONS THOROUGHLY FROM START TO FINISH BEFORE BEGINNING INSTALLATION! IF THESE INSTRUCTIONS ARE NOT PROPERLY FOLLOWED SEVERE FRAME, SUSPENSION AND TIRE DAMAGE MAY RESULT TO THE VEHICLE!</b></p> <p><b>** ICON VEHICLE DYNAMICS RECOMMENDS THAT YOU EXERCISE EXTREME CAUTION WHEN WORKING UNDER A VEHICLE THAT IS SUPPORTED WITH JACK STANDS.</b></p> <p><b>** ICON VEHICLE DYNAMICS RECOMMENDS ALL INSTALLATION TO BE PERFORMED BY A PROFESSIONAL SHOP/SERVICE TECHNICIAN. PRODUCT FAILURE CAUSED BY IMPROPER INSTALLATION WILL NOT BE COVERED UNDER ICON'S WARRANTY POLICY.</b></p>

## INSTALLATION

- Place the vehicle on a flat surface, verify that the transmission is shifted into PARK, firmly apply the emergency brake, and place wheel chocks on both sides of the tires.
- Remove the bolt connecting the rear track bar to the frame using a 21mm. [FIGURE 1]

FIG.1

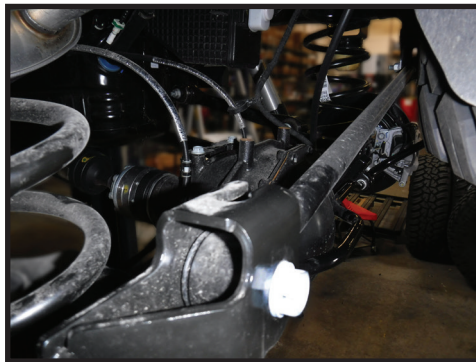

- Using a properly rated jack, raise the back of the vehicle and support the frame rails with jack stands. Ensure the jack stands are secure and set properly before lowering the jack. NEVER WORK UNDER AN UNSUPPORTED VEHICLE. Remove the rear wheels.

4. Support the rear differential and disconnect the lower shock bolts using a 21mm. [FIGURE 2]

FIG.2



5. Disconnect the rear sway bar from the frame using an 18mm. [FIGURE 3]

FIG.3



6. Disconnect the brake line bracket from the side of the frame using a 10mm. [FIGURE 4 & 5]

FIG.4

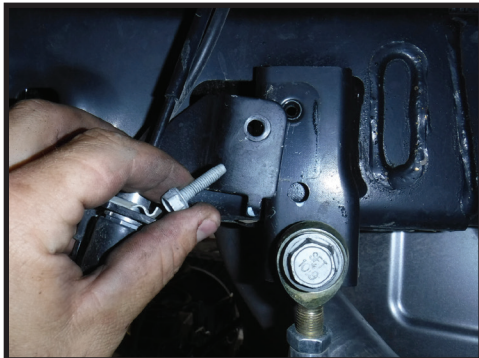

FIG.5



7. Disconnect the ABS line from the wire retainer on the differential.

8. Carefully lower the rear differential enough to remove the rear coils. [FIGURE 6 & 7]

FIG.6



FIG.7



**9.** Install the multi-rate coil spring. Ensure the upper coil isolator is located properly on the coil and the locator nipple is in the locating hole in the frame. [FIGURE 8 & 9]

FIG.8



FIG.9



**10.** Lift the differential enough to connect the shock. Connect the shocks using the factory bolt and a 21mm. [Torque to factory spec] [FIGURE 10 & 11]

FIG.10



FIG.11



**11.** Connect the ABS wire to the retainer on the differential.

**12.** Connect the brake line bracket to the frame using a 10mm and the factory bolt. [Torque to factory spec]

**13.** Mount the wheels and lower the vehicle to the ground. [Torque lugs to factory spec]

**14.** With the vehicle on the ground, connect the rear track bar using factory hardware and a 21mm. [Torque to factory spec] [FIGURE 12]

FIG.12



**VERIFY ALL FASTENERS ARE PROPERLY TORQUED BEFORE DRIVING VEHICLE.**

**RETORQUE ALL NUTS, BOLTS AND LUGS AFTER 100 MILES AND PERIODICALLY THEREAFTER.**

## ICON VEHICLE DYNAMICS LIMITED LIFETIME WARRANTY

ICON Vehicle Dynamics warrants to the original retail purchaser who owns the vehicle on which the product was originally installed. ICON Vehicle Dynamics does not warrant the product for finish, alterations, modifications and/or installation contrary to ICON Vehicle Dynamics instructions. ICON Vehicle Dynamics products are not designed, nor are they intended to be installed on vehicles used in race applications, for racing purposes or for similar activities. (A "race" is defined as any contest between two or more vehicles, or a contest of one or more vehicles against the clock, whether or not such contest is for a prize). This warranty does not include coverage for police or taxi vehicles, race vehicles, or vehicles used for government or commercial purposes. Also excluded from this warranty are sales outside of the United States of America and Canada.

ICON Vehicle Dynamics' obligation under this warranty is limited to the repair or replacement, at ICON Vehicle Dynamics' discretion, of the defective product. Any and all costs of removal, installation or re-installation, freight charges and incidental or consequential damages are expressly excluded from this warranty. Items that are subject to wear are not considered defective when worn and are not covered.

ICON Vehicle Dynamics components must be installed as a complete kit as shown in our current application guide. Any substitutions or exemptions of required components will immediately void the warranty. Some finish damage may happen to parts during shipping and is not covered under warranty.

This warranty is expressly in lieu of all other warranties expressed or implied. This warranty shall not apply to any product that has been improperly installed, modified or customized subject to accident, negligence, abuse or misuse.



**ICON VEHICLE DYNAMICS®**  
PERFORMANCE SUSPENSION SYSTEMS AND SHOCK ABSORBERS

7929 Lincoln Ave. Riverside, CA 92504 Phone: 951.689.ICON Fax: 951.689.1016  
[www.iconvehicledynamics.com](http://www.iconvehicledynamics.com)



**FOLLOW US ON FACEBOOK!**



7929 Lincoln Ave. Riverside, CA 92504  
Phone: 951.689.ICON | Fax: 951.689.1016

PART #	DESCRIPTION
22068	20-UP JT REAR ADJUSTABLE TRACK BAR KIT

COMPONENTS INCLUDED	
(1) 124079 20-UP JT REAR ADJUSTABLE TRACK BAR (1) 157520 L-R ADJ SLEEVE (2) 217200 HEIM SPACER RSMX12 X .565 X 1.625	(1) 295511 JM12T ROD END (1) 297105 GREASELESS BUSHING 1.508 X 14.3MM X 40.58MM
HARDWARE INCLUDED	
(2) 605147 3/8-16 X .75 12PT SCREW	
TOOLS REQUIRED	
TORQUE WRENCH 21MM SOCKET / WRENCH	3/8" 12PT SOCKET / WRENCH 1/4" PIN WRENCH
TECH NOTES	
<p>1. AFTER INSTALLATION IS COMPLETE, HAVE THE VEHICLE PROFESSIONALLY ALIGNED.</p> <p>2. DO NOT EXCEED 2.00" ADJUSTMENT FROM THE CENTER OF THE ROD END TO THE EDGE OF THE TRACK BAR PINCH HOUSING. FAILURE CAUSED BY EXCESSIVE ADJUSTMENT WILL NOT BE COVERED UNDER ICON'S WARRANTY POLICY.</p>	



WARNING!
<p>** READ ALL INSTRUCTIONS THOROUGHLY FROM START TO FINISH BEFORE BEGINNING INSTALLATION! IF THESE INSTRUCTIONS ARE NOT PROPERLY FOLLOWED SEVERE FRAME, SUSPENSION AND TIRE DAMAGE MAY RESULT TO THE VEHICLE!</p> <p>** ICON VEHICLE DYNAMICS RECOMMENDS THAT YOU EXERCISE EXTREME CAUTION WHEN WORKING UNDER A VEHICLE THAT IS SUPPORTED WITH JACK STANDS.</p> <p>** ICON VEHICLE DYNAMICS RECOMMENDS ALL INSTALLATION TO BE PERFORMED BY A PROFESSIONAL SHOP/SERVICE TECHNICIAN. PRODUCT FAILURE CAUSED BY IMPROPER INSTALLATION WILL NOT BE COVERED UNDER ICON'S WARRANTY POLICY.</p>

## INSTALLATION

1. Place the vehicle on a smooth, level surface. Ensure that the vehicle is in PARK, engage the emergency brake, and chock the tires before performing any work to the vehicle. ICON will not be held liable for any injuries or failure caused by improper installation.
2. Remove the stock track bar using two 21mm wrenches. [FIGURE 1 & 2]

FIG.1

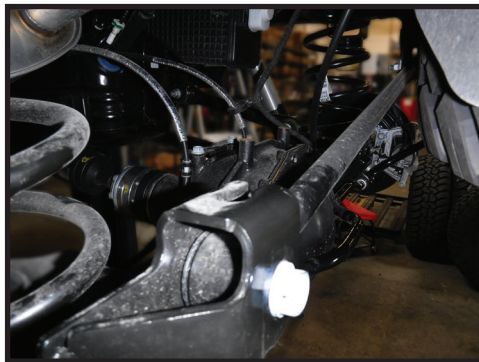
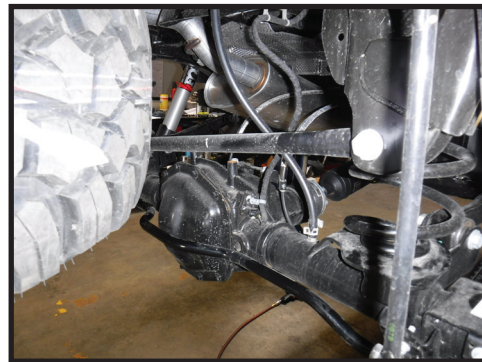

FIG.2



**3.** Install the new track bar with the rod end toward the axle. The pinch bolts should be on top and facing toward the rear of the vehicle. [FIGURE 3 & 4]

FIG.3



FIG.4



**4.** Torque bolts to factory spec using 21mm.

**5.** To adjust, loosen the pinch bolts billet link using a 3/8" 12pt. Turn the L/R adjusting collar to center the differential under the frame using a 1/4" pin wrench.

**6.** Never exceed the maximum length as listed in the tech notes.

**7.** Make sure that the slit in the collar is lined up with the slit in the pinch housing and tighten pinch bolts using an alternating pattern [Torque to 40 ft-lbs]. Go back and forth between bolts 3 times to torque equally.

**VERIFY ALL FASTENERS ARE PROPERLY TORQUED BEFORE DRIVING VEHICLE.**

**RETORQUE ALL NUTS, BOLTS AND LUGS AFTER 100 MILES AND PERIODICALLY THEREAFTER.**

### **ICON VEHICLE DYNAMICS LIMITED LIFETIME WARRANTY**

ICON Vehicle Dynamics warrants to the original retail purchaser who owns the vehicle on which the product was originally installed. ICON Vehicle Dynamics does not warrant the product for finish, alterations, modifications and/or installation contrary to ICON Vehicle Dynamics instructions. ICON Vehicle Dynamics products are not designed, nor are they intended to be installed on vehicles used in race applications, for racing purposes or for similar activities. (A "race" is defined as any contest between two or more vehicles, or a contest of one or more vehicles against the clock, whether or not such contest is for a prize). This warranty does not include coverage for police or taxi vehicles, race vehicles, or vehicles used for government or commercial purposes. Also excluded from this warranty are sales outside of the United States of America and Canada.

ICON Vehicle Dynamics' obligation under this warranty is limited to the repair or replacement, at ICON Vehicle Dynamics' discretion, of the defective product. Any and all costs of removal, installation or re-installation, freight charges and incidental or consequential damages are expressly excluded from this warranty. Items that are subject to wear are not considered defective when worn and are not covered.

ICON Vehicle Dynamics components must be installed as a complete kit as shown in our current application guide. Any substitutions or exemptions of required components will immediately void the warranty. Some finish damage may happen to parts during shipping and is not covered under warranty.

This warranty is expressly in lieu of all other warranties expressed or implied. This warranty shall not apply to any product that has been improperly installed, modified or customized subject to accident, negligence, abuse or misuse.



**ICON VEHICLE DYNAMICS®**  
PERFORMANCE SUSPENSION SYSTEMS AND SHOCK ABSORBERS

7929 Lincoln Ave. Riverside, CA 92504 Phone: 951.689.ICON Fax: 951.689.1016  
[www.iconvehicledynamics.com](http://www.iconvehicledynamics.com)



**FOLLOW US ON FACEBOOK!**



7929 Lincoln Ave. Riverside, CA 92504  
Phone: 951.689.ICON | Fax: 951.689.1016

PART #	DESCRIPTION
22070	20-UP JT REAR SWAY BAR LINK KIT

COMPONENTS INCLUDED	
(4) 169003 SLEEVE .750 X .510 X .250 (2) 197016 3/4" HEX BAR END LINK 9.25" LONG	(2) 295504 1/2-20 ROD END LEFT HAND SHANK RIGHT HAND STUD (2) 295512 1/2-20 ROD END
HARDWARE INCLUDED	
(4) 605330 1/2 FLAT WASHER (2) 605350 1/2-20 C-LOCK NUT	(2) 605355 1/2-20 JAM NUT THIN (2) 605356 1/2-20 LEFT HAND JAM NUT THIN
TOOLS REQUIRED	
TORQUE WRENCH 6MM ALLEN 18MM SOCKET / WRENCH	5/8" SOCKET / WRENCH 3/4" SOCKET / WRENCH
TECH NOTES	
<p>1. THE SWAY BAR LINKS COME PRESET AT ICON'S RECOMMENDED LENGTH TO PROPERLY WORK WITH ICON SUSPENSION SYSTEMS. CUSTOM SUSPENSION CONFIGURATIONS MAY REQUIRE ADDITIONAL ADJUSTMENT.</p> <p>2. IF ADJUSTING THE LINKS, DO NOT EXCEED 13.00" OF SWAY BAR LENGTH (EYE TO EYE).</p>	



WARNING!
<p><b>** READ ALL INSTRUCTIONS THOROUGHLY FROM START TO FINISH BEFORE BEGINNING INSTALLATION! IF THESE INSTRUCTIONS ARE NOT PROPERLY FOLLOWED SEVERE FRAME, SUSPENSION AND TIRE DAMAGE MAY RESULT TO THE VEHICLE!</b></p> <p><b>** ICON VEHICLE DYNAMICS RECOMMENDS THAT YOU EXERCISE EXTREME CAUTION WHEN WORKING UNDER A VEHICLE THAT IS SUPPORTED WITH JACK STANDS.</b></p> <p><b>** ICON VEHICLE DYNAMICS RECOMMENDS ALL INSTALLATION TO BE PERFORMED BY A PROFESSIONAL SHOP/SERVICE TECHNICIAN. PRODUCT FAILURE CAUSED BY IMPROPER INSTALLATION WILL NOT BE COVERED UNDER ICON'S WARRANTY POLICY.</b></p>

## INSTALLATION

1. These sway bar links can be installed with the vehicle on the ground at ride height or with the suspension fully extended.
2. Remove the rear sway bar links using an 18mm & 6mm allen. [FIGURE 1]

FIG.1



**3.** The sway bar links come preassembled by ICON and are preset to the recommended length. If using in a custom application, adjust as needed.

**4.** Mount the sway bar link with an opened eyelet on the passenger side using the supplied spacers and the factory bolt. [FIGURE 2]

FIG.2



**5.** Mount the stud of the rod end to the sway bar using 1/2" washers on both sides and torque nut to 50 ft-lbs using a 5/8" and 3/4" socket/wrench. [FIGURE 3]

FIG.3

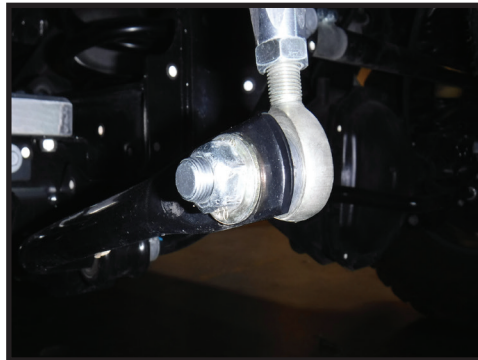

***VERIFY ALL FASTENERS ARE PROPERLY TORQUED BEFORE DRIVING VEHICLE.***

***RETORQUE ALL NUTS, BOLTS AND LUGS AFTER 100 MILES AND PERIODICALLY THEREAFTER.***

### ***ICON VEHICLE DYNAMICS LIMITED LIFETIME WARRANTY***

ICON Vehicle Dynamics warrants to the original retail purchaser who owns the vehicle on which the product was originally installed. ICON Vehicle Dynamics does not warrant the product for finish, alterations, modifications and/or installation contrary to ICON Vehicle Dynamics instructions. ICON Vehicle Dynamics products are not designed, nor are they intended to be installed on vehicles used in race applications, for racing purposes or for similar activities. (A "race" is defined as any contest between two or more vehicles, or a contest of one or more vehicles against the clock, whether or not such contest is for a prize). This warranty does not include coverage for police or taxi vehicles, race vehicles, or vehicles used for government or commercial purposes. Also excluded from this warranty are sales outside of the United States of America and Canada.

ICON Vehicle Dynamics' obligation under this warranty is limited to the repair or replacement, at ICON Vehicle Dynamics' discretion, of the defective product. Any and all costs of removal, installation or re-installation, freight charges and incidental or consequential damages are expressly excluded from this warranty. Items that are subject to wear are not considered defective when worn and are not covered.

ICON Vehicle Dynamics components must be installed as a complete kit as shown in our current application guide. Any substitutions or exemptions of required components will immediately void the warranty. Some finish damage may happen to parts during shipping and is not covered under warranty.

This warranty is expressly in lieu of all other warranties expressed or implied. This warranty shall not apply to any product that has been improperly installed, modified or customized subject to accident, negligence, abuse or misuse.

7929 Lincoln Ave. Riverside, CA 92504  
Phone: 951.689.ICON | Fax: 951.689.1016

PART #	DESCRIPTION
27727CP	20-UP JT 1.5" REAR 2.5 VS PB CDCV

COMPONENTS INCLUDED	
(2) 124957C 20-UP JT 1.5" REAR 2.5 VS PB CDCV	
HARDWARE INCLUDED	
N/A	
TOOLS REQUIRED	
JACK JACK STANDS TORQUE WRENCH 21MM SOCKET / WRENCH	
TECH NOTES	
<p>1. YOUR ICON SHOCK ASSEMBLIES COME FACTORY CHARGED TO 150 PSI. RELEASING NITROGEN PRESSURE MAY LEAD TO SHOCK MALFUNCTION AND REDUCED RIDE QUALITY. FAILURE CAUSED BY LOW NITROGEN PRESSURE IS NOT COVERED UNDER ICON'S WARRANTY POLICY.</p> <p>2. INTENDED FOR USE WITH: 22065 (20-UP JT 1 3/8" REAR COIL SPACER KIT) OR 22066 (20-UP JT 2.5" REAR MULTI-RATE SPRING KIT)</p>	



WARNING!
<p>** READ ALL INSTRUCTIONS THOROUGHLY FROM START TO FINISH BEFORE BEGINNING INSTALLATION! IF THESE INSTRUCTIONS ARE NOT PROPERLY FOLLOWED SEVERE FRAME, SUSPENSION AND TIRE DAMAGE MAY RESULT TO THE VEHICLE!</p> <p>** ICON VEHICLE DYNAMICS RECOMMENDS THAT YOU EXERCISE EXTREME CAUTION WHEN WORKING UNDER A VEHICLE THAT IS SUPPORTED WITH JACK STANDS.</p> <p>** ICON VEHICLE DYNAMICS RECOMMENDS ALL INSTALLATION TO BE PERFORMED BY A PROFESSIONAL SHOP/SERVICE TECHNICIAN. PRODUCT FAILURE CAUSED BY IMPROPER INSTALLATION WILL NOT BE COVERED UNDER ICON'S WARRANTY POLICY.</p>

## INSTALLATION

- Using a properly rated jack, raise the rear of the vehicle and support the frame rails with jack stands. Ensure the jack stands are secure and set properly before lowering the jack. NEVER WORK UNDER AN UNSUPPORTED VEHICLE. Remove rear wheels.
- Remove the factory shocks using a 21mm. [FIGURE 1 & 2]

FIG.1



FIG.2



**NOTE:** It is easiest to install shocks at full droop.

**3.** Install the ICON rear shocks as shown using factory hardware and torque to factory spec using a 21mm. The reservoir goes toward the axle and the shaft protector goes toward the front of the vehicle. Install the longer heim spacers towards the frame to position the shock outward away from the frame. **[FIGURE 3 & 4]**

**FIG.3**



**FIG.4**



**4.** Reinstall rear wheels and lower the vehicle back to the ground. [Torque lugs to factory spec]

***VERIFY ALL FASTENERS ARE PROPERLY TORQUED BEFORE DRIVING VEHICLE.***

***RETORQUE ALL NUTS, BOLTS AND LUGS AFTER 100 MILES AND PERIODICALLY THEREAFTER.***

## 2.5 VS SERIES SHOCK & COILOVER TECHNICAL INFORMATION

### MAINTENANCE

ICON shock absorbers are a high quality rebuildable race style shock absorber designed for optimal performance. With a unit of this caliber on your vehicle, routine maintenance is required to keep them looking and operating in like new condition. Residual oil and assembly lube may be present at all seal paths from the factory out of the box and is considered normal. Pooling of oil however is not acceptable at any time and one should contact the ICON dealer where purchased.

**BELOW ARE GUIDELINES BASED ON HOW YOU USE YOUR VEHICLE BUT YOUR MILEAGE MAY VARY:**

#### **STREET USE:**

- Send in for factory servicing every 40,000 miles or if a leak develops, ride quality decreases, or they begin to make excessive noise.
- Remove any buildup of road salt, mud, or debris from shocks and coil springs anytime accrued
- Clean with mild soap and water with each oil change or anytime you notice build up.
- Wax the cylinders yearly with automotive wax to prevent corrosion.
- Check nitrogen pressure yearly. (252004 charge needle assembly available at any ICON distributor)
- Check bearings for excessive wear yearly.
- DO NOT apply any type of lube to the upper and lower bearings.

#### **STREET/DIRT:**

- Send in for factory servicing every 15,000 miles or if a leak develops, ride quality decreases, or they begin to make excessive noise.
- Clean with mild soap and water with each oil change, offroad trip, or anytime you notice build up.
- Wax the cylinders yearly with automotive wax to prevent corrosion.
- Check nitrogen pressure each dirt outing. (252004 charge needle assembly available at any ICON distributor)
- Check bearings for excessive wear yearly.
- DO NOT apply any type of lube to the upper and lower bearings.

#### **DIRT USE:**

- Send in for factory servicing every 1,000 miles.
- Check nitrogen pressure each outing. (252004 charge needle assembly available at any ICON distributor)
- Remove any buildup of mud or debris from shocks and coil springs after every outing.

#### **SELF-SERVICE:**

- Contact ICON for service kits & tools at (951) 689-4266.

### PRODUCT REGISTRATION

Please visit: <http://www.iconvehicledynamics.com/tech-support/registration/> to register your product.

### ICON VEHICLE DYNAMICS SHOCK ABSORBER WARRANTY

This shock absorber has a 1 year warranty against any manufacturer's defects. If a shock fails within the initial year of ownership, the shock must be shipped to ICON Vehicle Dynamics for inspection and service. If a shock is inspected and it has been determined the shock failed due to neglect, damage caused by improper installation or any other reason besides "normal wear and tear", the owner of said shock is responsible for all service costs. This includes labor, parts, and shipping.

ICON Vehicle Dynamics warrants to the original retail purchaser who owns the vehicle on which the product was originally installed. ICON Vehicle Dynamics does not warrant the product for finish, alterations, modifications and/or installation contrary to ICON Vehicle Dynamics instructions. ICON Vehicle Dynamics products are not designed, nor are they intended to be installed on vehicles used in race applications, for racing purposes or for similar activities. (A "race" is defined as any contest between two or more vehicles, or a contest of one or more vehicles against the clock, whether or not such contest is for a prize). This warranty does not include coverage for police or taxi vehicles, race vehicles, or vehicles used for government or commercial purposes. Also excluded from this warranty are sales outside of the United States of America and Canada.

ICON Vehicle Dynamics' obligation under this warranty is limited to the repair or replacement, at ICON Vehicle Dynamics' discretion, of the defective product. Any and all costs of removal, installation or re-installation, freight charges and incidental or consequential damages are expressly excluded from this warranty. Items that are subject to wear are not considered defective when worn and are not covered.

ICON Vehicle Dynamics components must be installed as a complete kit as shown in our current application guide. Any substitutions or exemptions of required components will immediately void the warranty. Some finish damage may happen to parts during shipping and is not covered under warranty.

This warranty is expressly in lieu of all other warranties expressed or implied. This warranty shall not apply to any product that has been improperly installed, modified or customized subject to accident, negligence, abuse or misuse.

To send a shock in for warranty please visit our website <http://www.iconvehicledynamics.com/tech-support/shock-service/>



**ICON VEHICLE DYNAMICS®**  
PERFORMANCE SUSPENSION SYSTEMS AND SHOCK ABSORBERS

7929 Lincoln Ave. Riverside, CA 92504 Phone: 951.689.ICON Fax: 951.689.1016  
[www.iconvehicledynamics.com](http://www.iconvehicledynamics.com)



**FOLLOW US ON FACEBOOK!**



PART #	DESCRIPTION
27821CP	18-UP JL 2.5" LIFT FRONT REMOTE RESERVOIR 2.5 CDCV SHOCK PAIR

COMPONENTS INCLUDED	
(1) 124953RCD 18+ JL 2.5" LIFT FRONT REMOTE RESERVOIR 2.5 CDCV SHOCK DRVR (1) 124953RCP 18+ JL 2.5" LIFT FRONT REMOTE RESERVOIR 2.5 CDCV SHOCK PASS (1) 120050D 18+ JL JT RESI MOUNT DRVR	(1) 120050P 18+ JL JT RESI MOUNT PASS (1) 120052D 18+ JL JT RESI HEAT SHIELD DRVR (1) 120052P 18+ JL JT RESI HEAT SHIELD PASS (1) 611051 STAINLESS HOSE CLAMP KIT
HARDWARE INCLUDED	
(18) 605004 #10 SAE FLAT WASHER (6) 605036 10-32 X .500 BUTTON HEAD SCREW	(6) 605042 10-32 NYLOCK NUT (4) 605144 3/8-12 X .75 FLANGED SELF TAPPING SCREW
TOOLS REQUIRED	
FLOOR JACK OSCILLATING SAW TORQUE WRENCH 11/32 DRILL BIT CENTER PUNCH	1/8" ALLEN 3/8" SOCKET / WRENCH 5/16" SOCKET / WRENCH 9/16" SOCKET / WRENCH 18MM SOCKET / WRENCH
TECH NOTES	
<p>1. THIS SHOCK REQUIRES AT LEAST 1" OF BUMPSTOP SPACER TO AVOID DAMAGE.</p> <p>2. YOUR ICON SHOCK ASSEMBLIES COME FACTORY CHANGED TO 150 PSI. RELEASING NITROGEN PRESSURE MAY LEAD TO SHOCK MALFUNCTION AND REDUCED RIDE QUALITY. FAILURE CAUSED BY LOW NITROGEN PRESSURE IS NOT COVERED UNDER ICON'S WARRANTY POLICY.</p> <p>3. SHOCKS ARE INTENDED FOR 3.6L V6 ONLY.</p>	

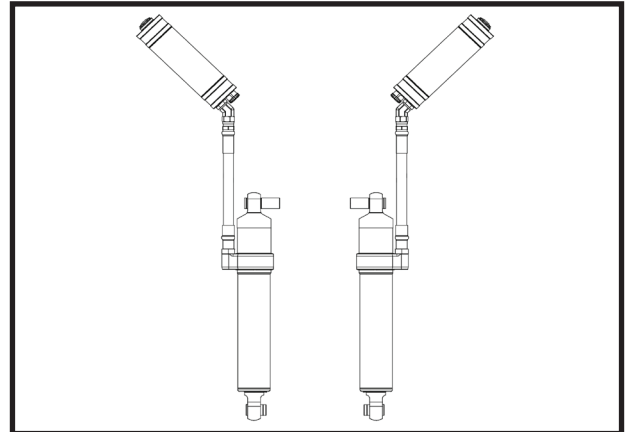

**WARNING!**

**\*\* READ ALL INSTRUCTIONS THOROUGHLY FROM START TO FINISH BEFORE BEGINNING INSTALLATION! IF THESE INSTRUCTIONS ARE NOT PROPERLY FOLLOWED SEVERE FRAME, SUSPENSION AND TIRE DAMAGE MAY RESULT TO THE VEHICLE!**

**\*\* ICON VEHICLE DYNAMICS RECOMMENDS THAT YOU EXERCISE EXTREME CAUTION WHEN WORKING UNDER A VEHICLE THAT IS SUPPORTED WITH JACK STANDS.**

**\*\* ICON VEHICLE DYNAMICS RECOMMENDS ALL INSTALLATION TO BE PERFORMED BY A PROFESSIONAL SHOP/SERVICE TECHNICIAN. PRODUCT FAILURE CAUSED BY IMPROPER INSTALLATION WILL NOT BE COVERED UNDER ICON'S WARRANTY POLICY.**

## INSTALLATION

**1.** Remove the factory rear shock using a 18mm. [FIGURE 1]

FIG.1



**2.** Using factory hardware, install the 2.5" front shocks with the long spacers towards the frame. Shocks are labeled DRVR & PASS. Use a 18mm and torque to factory spec. [FIGURE 2]

FIG.2

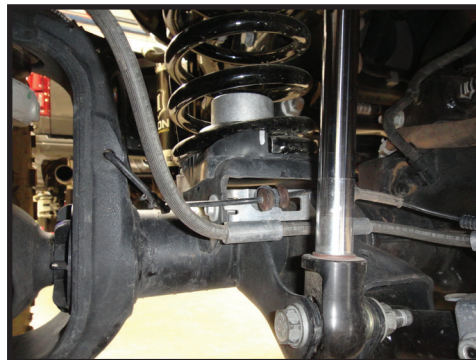

**3.** Assemble the heat shields (PN: 120052D/P) to the reservoir brackets (PN: 120050D/P). Position the button head screws (PN: 605036) through the reservoir bracket. Place 3 washers (PN: 605004) on each of the screws. Position the heat shield and start the nuts (PN: 605042). Torque to 45 in-lbs using a 1/8 Allen and a 3/8. [FIGURE 3 & 4]

FIG.3



FIG.4



**4.** Position the reservoir bracket over the opening in the side of the frame rail. Line up the curvature of the bracket with the curvature of the top of the window in the side of the frame. Mark the hole locations using a marker. Remove the bracket. [FIGURE 5]

FIG.5



**5.** Center punch and drill the holes using a 11/32 drill bit. Use a 9/16 and the self tapping screws (PN: 605144) to form the threads.

**6.** Mount the reservoir bracket to the frame using the self tapping screws. Torque to 18 ft-lbs using a 9/16.

**7.** Mount the reservoir to the bracket using the supplied hose clamps and a 5/16.

**8.** Trim the fender liner as necessary using an oscillating saw.

***VERIFY ALL FASTENERS ARE PROPERLY TORQUED BEFORE DRIVING VEHICLE.***

***RETORQUE ALL NUTS, BOLTS AND LUGS AFTER 100 MILES AND PERIODICALLY THEREAFTER.***

## 2.5 VS SERIES SHOCK & COILOVER TECHNICAL INFORMATION

### MAINTENANCE

ICON shock absorbers are a high quality rebuildable race style shock absorber designed for optimal performance. With a unit of this caliber on your vehicle, routine maintenance is required to keep them looking and operating in like new condition. Residual oil and assembly lube may be present at all seal paths from the factory out of the box and is considered normal. Pooling of oil however is not acceptable at any time and one should contact the ICON dealer where purchased.

**BELOW ARE GUIDELINES BASED ON HOW YOU USE YOUR VEHICLE BUT YOUR MILEAGE MAY VARY:**

#### **STREET USE:**

- Send in for factory servicing every 40,000 miles or if a leak develops, ride quality decreases, or they begin to make excessive noise.
- Remove any buildup of road salt, mud, or debris from shocks and coil springs anytime accrued
- Clean with mild soap and water with each oil change or anytime you notice build up.
- Wax the cylinders yearly with automotive wax to prevent corrosion.
- Check nitrogen pressure yearly. (252004 charge needle assembly available at any ICON distributor)
- Check bearings for excessive wear yearly.
- DO NOT apply any type of lube to the upper and lower bearings.

#### **STREET/DIRT:**

- Send in for factory servicing every 15,000 miles or if a leak develops, ride quality decreases, or they begin to make excessive noise.
- Clean with mild soap and water with each oil change, offroad trip, or anytime you notice build up.
- Wax the cylinders yearly with automotive wax to prevent corrosion.
- Check nitrogen pressure each dirt outing. (252004 charge needle assembly available at any ICON distributor)
- Check bearings for excessive wear yearly.
- DO NOT apply any type of lube to the upper and lower bearings.

#### **DIRT USE:**

- Send in for factory servicing every 1,000 miles.
- Check nitrogen pressure each outing. (252004 charge needle assembly available at any ICON distributor)
- Remove any buildup of mud or debris from shocks and coil springs after every outing.

#### **SELF-SERVICE:**

- Contact ICON for service kits & tools at (951) 689-4266.

### PRODUCT REGISTRATION

Please visit: <http://www.iconvehicledynamics.com/tech-support/registration/> to register your product.

### ICON VEHICLE DYNAMICS SHOCK ABSORBER WARRANTY

This shock absorber has a 1 year warranty against any manufacturer's defects. If a shock fails within the initial year of ownership, the shock must be shipped to ICON Vehicle Dynamics for inspection and service. If a shock is inspected and it has been determined the shock failed due to neglect, damage caused by improper installation or any other reason besides "normal wear and tear", the owner of said shock is responsible for all service costs. This includes labor, parts, and shipping.

ICON Vehicle Dynamics warrants to the original retail purchaser who owns the vehicle on which the product was originally installed. ICON Vehicle Dynamics does not warrant the product for finish, alterations, modifications and/or installation contrary to ICON Vehicle Dynamics instructions. ICON Vehicle Dynamics products are not designed, nor are they intended to be installed on vehicles used in race applications, for racing purposes or for similar activities. (A "race" is defined as any contest between two or more vehicles, or a contest of one or more vehicles against the clock, whether or not such contest is for a prize). This warranty does not include coverage for police or taxi vehicles, race vehicles, or vehicles used for government or commercial purposes. Also excluded from this warranty are sales outside of the United States of America and Canada.

ICON Vehicle Dynamics' obligation under this warranty is limited to the repair or replacement, at ICON Vehicle Dynamics' discretion, of the defective product. Any and all costs of removal, installation or re-installation, freight charges and incidental or consequential damages are expressly excluded from this warranty. Items that are subject to wear are not considered defective when worn and are not covered.

ICON Vehicle Dynamics components must be installed as a complete kit as shown in our current application guide. Any substitutions or exemptions of required components will immediately void the warranty. Some finish damage may happen to parts during shipping and is not covered under warranty.

This warranty is expressly in lieu of all other warranties expressed or implied. This warranty shall not apply to any product that has been improperly installed, modified or customized subject to accident, negligence, abuse or misuse.

To send a shock in for warranty please visit our website <http://www.iconvehicledynamics.com/tech-support/shock-service/>



**ICON VEHICLE DYNAMICS®**  
PERFORMANCE SUSPENSION SYSTEMS AND SHOCK ABSORBERS

7929 Lincoln Ave. Riverside, CA 92504 Phone: 951.689.ICON Fax: 951.689.1016  
[www.iconvehicledynamics.com](http://www.iconvehicledynamics.com)



**FOLLOW US ON FACEBOOK!**

