



# **INSTALLATION INSTRUCTIONS**

**BLACK ATLAS ROLL BAR FOR JEEP GLADIATOR 2020(WITH  
TONNEAU COVER BASE)**

**PART # ATRB9BK**

## Before Installation

- Please read the instruction completely for easy installation, which will also help you to avoid scratches or other potential damages to your appealing car.
- The figures here are for reference only and may have differences with the actual product you received, however they share the same assembly way.







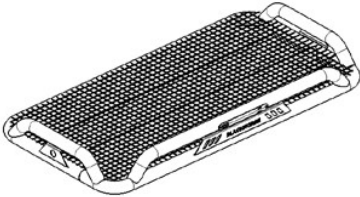
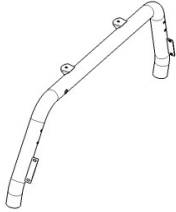
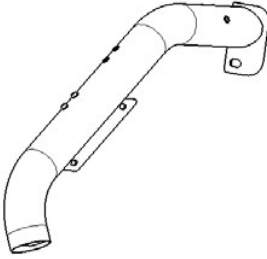
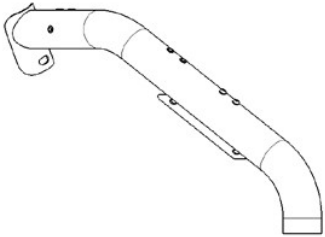
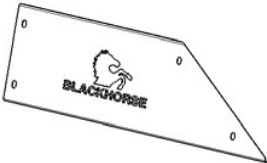
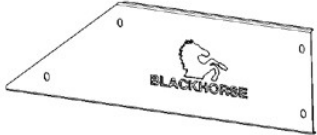
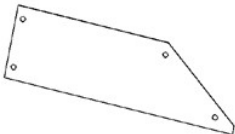
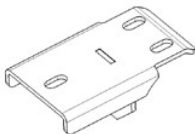



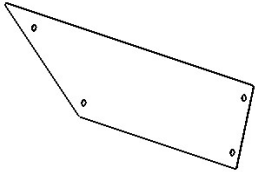
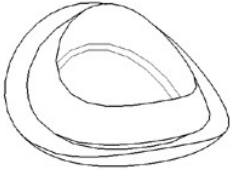



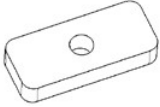
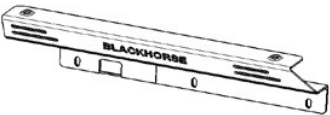

## Care and Cleaning

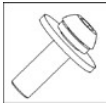
- Mild soap may be used also to clean the Product.
- Please periodically check and retighten all the hardware and clean the investment for a refresh look.

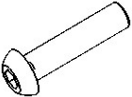





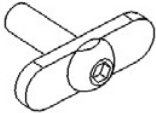

## Parts list

NO.	QTY	NAME	NO.	QTY	NAME
①	1	 Luggage frame (with LED light)	②	1	 Main tube 1
③	1	 Side tube-L	④	1	 Side tube-R
⑤	1	 Decoration plate-L	⑥	1	 Decoration plate-R
⑦	2	 Red decoration plate	⑧	2	 Connect bracket 1

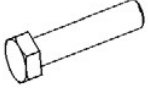
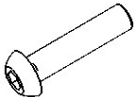
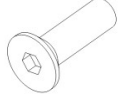
BLACK ATLAS ROLL BAR FOR JEEP GLADIATOR 2020(WITH TONNEAU COVER BASE)

<p>⑨</p> <p>2</p>		<p>⑩</p> <p>2</p>	
<p>⑪</p> <p>1</p>		<p>⑫</p> <p>1</p>	
<p>⑬</p> <p>1</p>		<p>⑭</p> <p>2</p>	
<p>⑮</p> <p>1</p>		<p>⑯</p> <p>1</p>	
<p>⑰</p> <p>4</p>		<p>⑱</p> <p>8</p>	
<p>⑲</p> <p>8</p>		<p>⑳</p> <p>8</p>	
<p>㉑</p> <p>2</p>		<p>㉒</p> <p>8</p>	
<p>㉓</p> <p>14</p>		<p>㉔</p> <p>6</p>	
<p>㉕</p> <p>2</p>		<p>㉖</p> <p>8</p>	

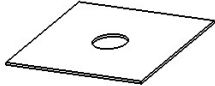
BLACK ATLAS ROLL BAR FOR JEEP GLADIATOR 2020(WITH TONNEAU COVER BASE)

<p>②⑦</p>	<p>6</p>	 <p>T-Hex nut M10_35</p>	<p>②⑧</p>	<p>6</p>	 <p>Hex nut M10</p>
<p>②⑨</p>	<p>8</p>	 <p>Spring washer D10</p>	<p>③⑩</p>	<p>2</p>	 <p>Hex nut M10_25</p>
<p>③①</p>	<p>2</p>	 <p>Button head allen bolts M12_40</p>	<p>③②</p>	<p>4</p>	 <p>Flat head allen bolts M12_40</p>
<p>③③</p>	<p>2</p>	 <p>Flat washer D12</p>	<p>③④</p>	<p>1</p>	 <p>Allen wrench S=8</p>
<p>③⑤</p>	<p>1</p>	 <p>Allen wrench S=4</p>	<p>③⑥</p>	<p>1</p>	 <p>Allen wrench S=5</p>
<p>③⑦</p>	<p>6</p>	 <p>PVC</p>	<p>③⑧</p>	<p>5</p>	 <p>Black adhesive tape</p>

## Installation Steps

**Step1:** Assemble tubes with standard parts. Lock all the standard parts after adjust the position.

Use standard parts ⑩ ③①

③③ to connect ② ③.

Installation are same at both sides.

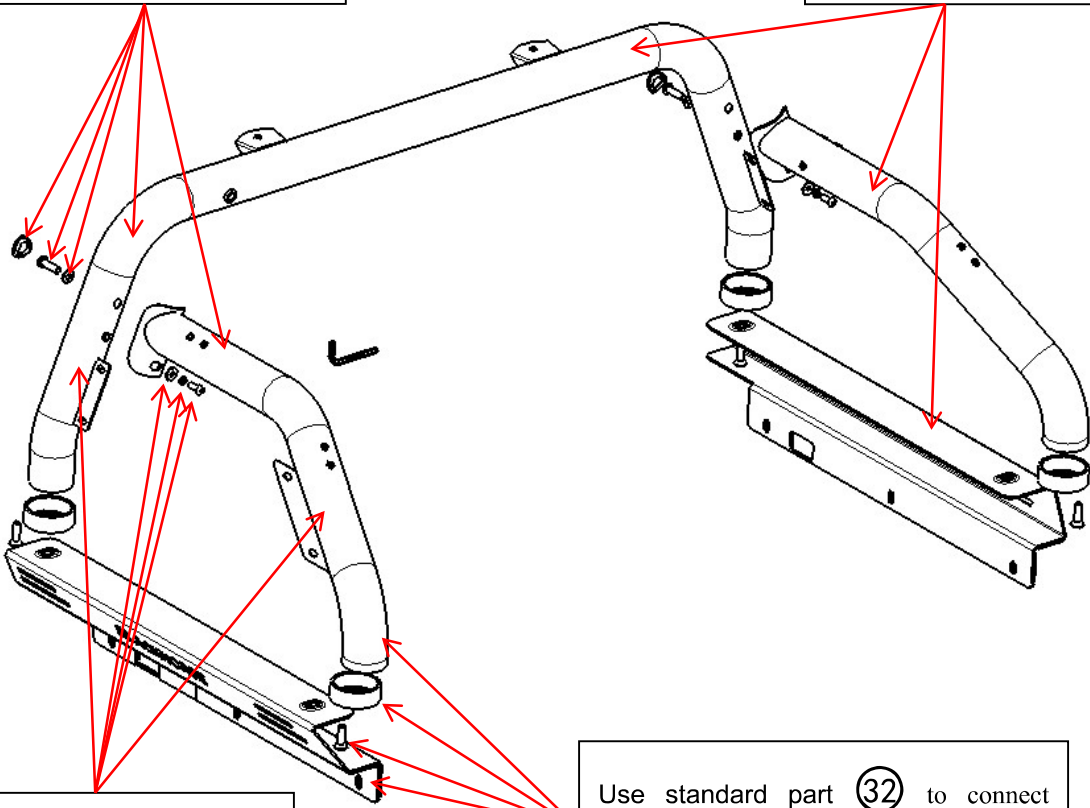

Use standard parts ②⑥ ②⑨  
③① to connect ② ③.

Use standard part ③② to connect  
①⑤ ①⑦ on tube.

BLACK ATLAS ROLL BAR FOR JEEP GLADIATOR 2020(WITH TONNEAU COVER BASE)

**Step2:** Assemble Luggage frame and tubes with standard parts. Lock all the standard parts after adjust the position.

Use standard parts ②① ②② ②④ ②⑤ to connect ①③ ①④ on the tubes. 2 places.

Use standard parts ②② ②③ ②④ to connect ① on the tubes. 4 places.

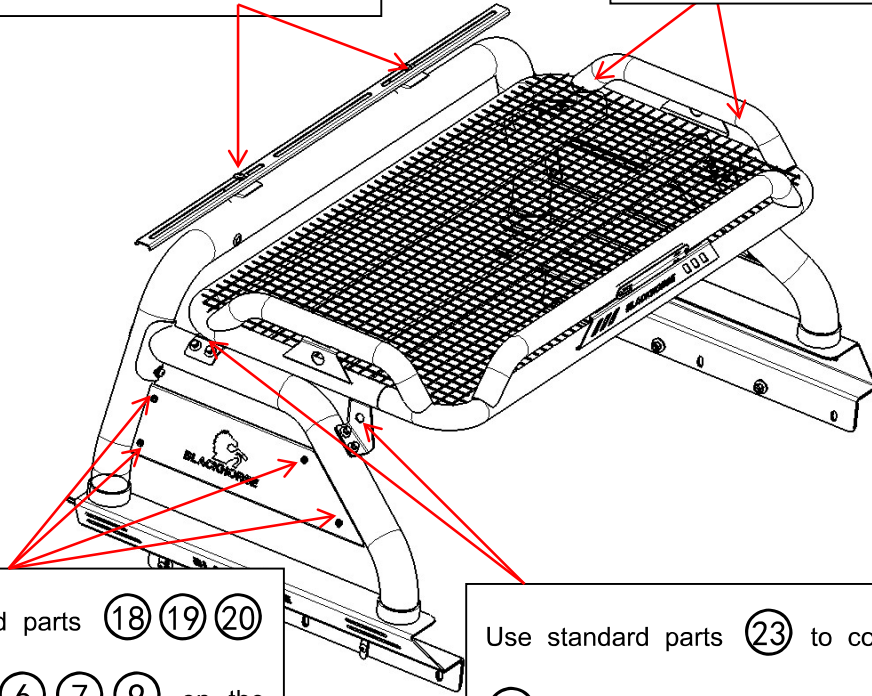

Use standard parts ①⑧ ①⑨ ②① to connect ⑥ ⑦ ⑨ on the tubes. 8 places.

Use standard parts ②③ to connect ⑧ ①① ①② on the tubes. 8 places.

**Step3:** Put roll bar on the truck in an appropriate place. And use pen to mark the holes. 3 places in each part, 6 places total. Remove the roll bar then drill the size of  $\Phi 12$  holes. Put the roll bar back and use standard ②⑥ ②⑦ ②⑧ ②⑨ ③⑦ to fasten.

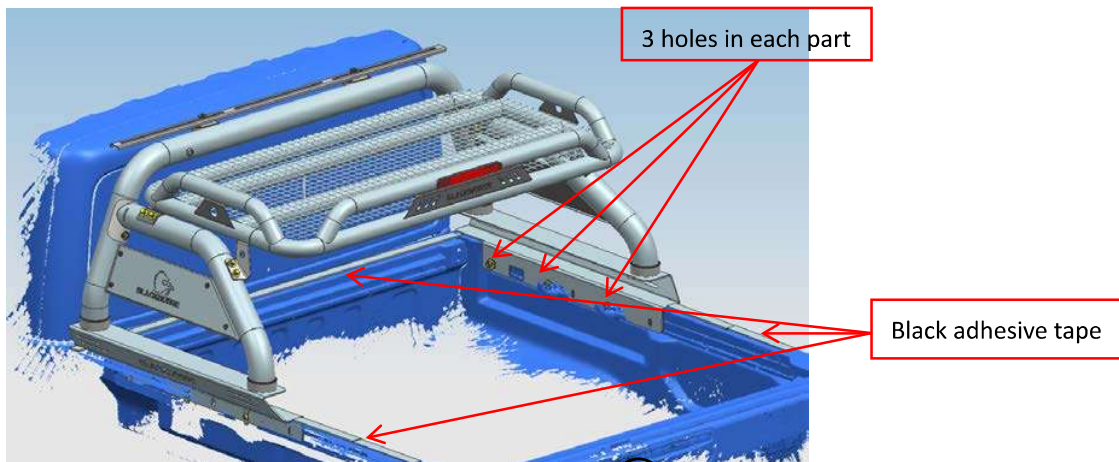

Notice: If compatible with tonneau cover, pls sticker the black adhesive tape ③⑧ on the truck rail to full fill the gap as the picture shown.

**NOTE**

Any damages and losses caused by improper installation and application, goes beyond our quality warranty.