

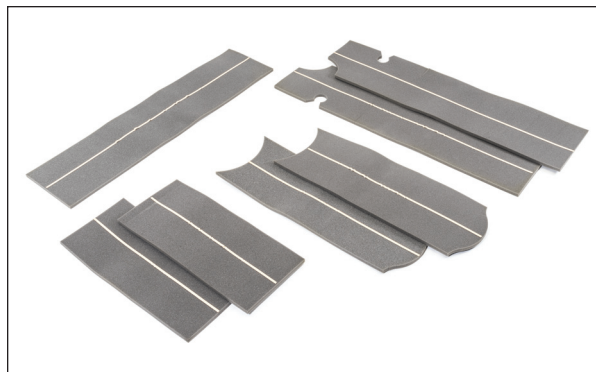

Installation Instructions

Sport Bar Covers for 1992-1995 Jeep® Wrangler YJ Vehicles Part #12203115

Later Style YJ 92-95
YJ Wrangler with
Sport Bar Covers



Parts List:

- Main Sport Bar Fabric - Qty 1
- Horizontal Tube Fabric & Foam - Qty 2
- Accent Foam with Adhesive - Qty 7

Required Tools:

- Safety Glasses
- T50 Torx Bit and Driver
- Small Flat Head Screw Driver

⚠ WARNING ⚠

This product is designed to enhance the look of your vehicle. NEVER rely in any way on this product or its components to protect the occupants of the vehicle from injury or death in the event of an accident. This product will not contain the occupants in the vehicle. This product will not protect the occupants from falling objects or impact from other vehicles. Always wear your seat belts and never operate the vehicle in excess of the manufacturer's specifications.

⚠ CAUTION ⚠

RISK OF EYE INJURY. Safety glasses should be worn at all times while installing or maintaining this product.



Important Safety information

Your MasterTop® Sport Bar Cover is intended to enhance the appearance of your off-road capable vehicle. Before installation, please take a moment to review the following safety information and installation instructions. Important safety information is generally preceded by one of three signal words indicating the relative risk of injury.

The signal words mean:

WARNING

A hazardous situation which, if not avoided, could result in death or serious injury. You CAN be KILLED or SERIOUSLY HURT if you don't follow instructions.

CAUTION

A hazardous situation which, if not avoided, could result in minor or moderate injury. You CAN be moderately HURT and also may suffer property damage if you don't follow instructions.

NOTICE

Careful attention is required to this instruction or operation but does generally not relate to personal injury. Damage to your MasterTop product or other property may result if you don't follow instructions.

Before you begin Installation:

We are excited that you have chosen the MasterTop Sport Bar Cover! This high quality Cover is designed to enhance the appearance of your vehicle. Please note that it is important that you become familiar with the installation process of this product by reading the following instruction sheet and warnings thoroughly. Though we have used only the finest materials in creating this cover, any product that is exposed to the elements requires some general maintenance to keep it looking like new. Please see page 6 for these important maintenance tips. Please also note that it is normal for fabric to contract and wrinkle when stored in the shipping carton. In a few days the fabric will relax and wrinkles will disappear.

NOTICE

For a smooth fit and ease of installation, this cover should be installed at temperatures above 72 degrees. Below this temperature, the fabric may contract an inch or more making it difficult to install. We highly recommend taking the cover out of the package and letting it sit inside a warm place or direct sunlight for 1-2 hours before you install the top. When warm, this cover will install quickly.

When unpacking, check to make sure all parts are included.

If any part is missing or broken, please call MasterTop customer service at 720-575-5440.

Pre-Installation Notes for Sport Bar Covers:

If you have a top on your vehicle it will need to be removed before starting this installation. Remove the factory Sport Bar Cover and accent foam from the vehicle. The factory cover will zip off the main hoop and rear legs.

On the Factory Horizontal tubes, you will need to carefully cut them off with a razor knife.

NOTICE

This product has been designed to fit Jeep vehicles that have the factory Sport Bar Covers removed from the vehicle. Do not try to install these covers over your factory covers as they will be too small and damage to the product can occur



FIG A

Part A: Removal and Replacement of Factory Seat Belt Mounts (Front and Rear)

Installation of this Sport Bar Cover will require you to temporarily disconnect your seat belts from the front and rear Sport Bar.

With a small screw driver, carefully open up the cap covering the seat belt bolt. See Fig A



Pre-Installation and Installation of Sport Bar Covers:



Part B: Removal and Replacement of Factory Seat Belt Mounts (Front and Rear)

Using a #50 Torx bit and socket driver, remove the bolt from the Sport bar. Upon removal, be careful not to lose the small plastic washer located between the seat belt and the end of the bolt.

Carefully set the seat belt and bolt assembly on the front/rear seats for re-installation once the new Sport Bar Covers are installed. See Fig B & C.

The actual installation can now begin. See below:

WARNING

You must re-install your Seat belts, front and rear into the Sport Bar upon completion of the cover installation. Failure to do so may cause severe injury or death if you are in an accident. The seat belt bolts must be tightened until you can no longer turn the bolt. Never leave these bolts partially tightened.

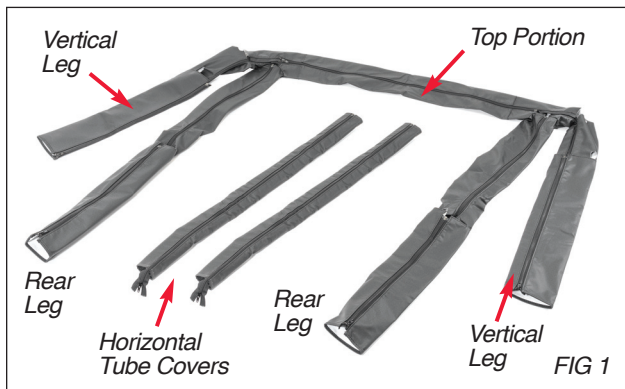

Step 1: Prepare Fabric for Installation

Lay out and open the Sport Bar fabric on a clean dry surface with the vinyl side facing down. Orient where each part of the cover will go on the vehicle.

The Top portion will go over the center hoop, the vertical legs will go down from the top of the center hoop around the seat belt cut outs, the rear legs will attach to the rear Sport Bar braces and the horizontal covers will go over the driver and passenger door horizontal tubes. See Fig 1.

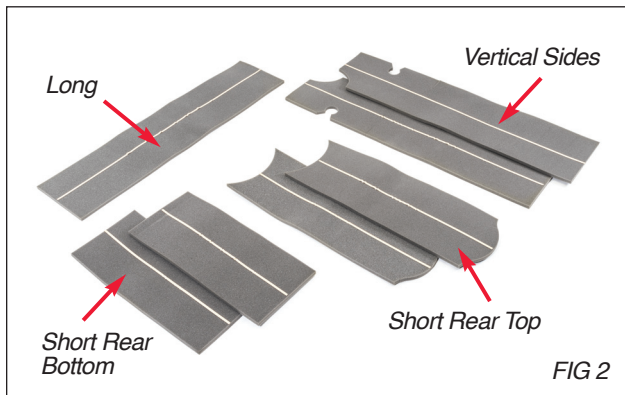

Step 2: Installing Top Foam to Cover

Identify each foam piece as shown in Fig 2. Lay the long piece of foam, with the tape side down, on the top portion of the fabric assembly identified in Fig 1. This foam piece runs from one end of the zipper to the other. Make sure that the foam is centered on the fabric. Lift the foam up enough to remove the protective strip from the adhesive and press the foam firmly into place on the fabric. See Fig 3A.



NOTICE

The adhesive tape installed on the foam is designed to assist in installation only and is not designed for permanent adhesion.



Installation of Sport Bar Covers:



FIG 3b

Step 3: Installing The Vertical Foam to the Cover

Identify the Vertical foam piece as shown in Fig 2.

Lay the vertical piece of foam, with the tape side down, on each of the legs of the fabric assembly on each side of the Top foam identified in Fig 1. The seat belt cutouts on each piece of foam should be facing up towards the center. Make sure that the foam is centered on the fabric. Lift the foam up enough to remove the protective strip from the adhesive and press the foam firmly into place on the fabric. See Fig 3B.

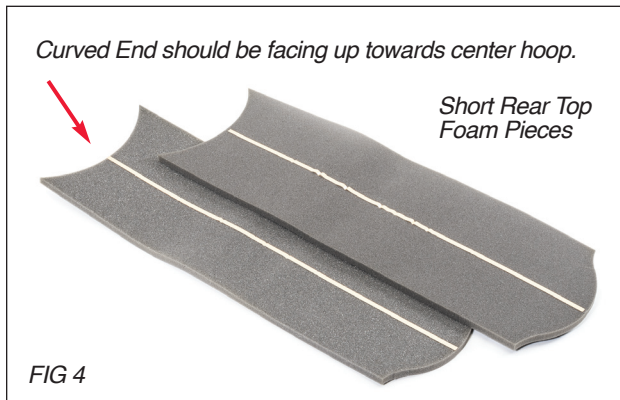

FIG 4

Step 4: Installing the Short Rear Top Foam to the Cover

Identify the Short Rear Top foam piece as shown in Fig 2 and at left.

Lay the Short Rear Top foam, with the tape side down and the curved Portion facing up, on each of the legs of the fabric assembly identified in Fig 1. Make sure that the foam is centered on the fabric.

Lift the foam up enough to remove the protective strip from the adhesive and press the foam firmly into place on the fabric. See Fig 4

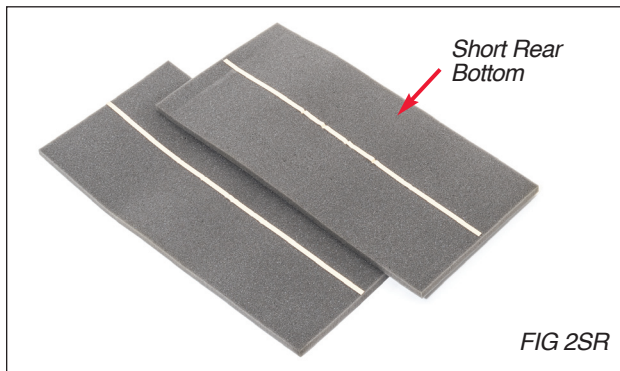

FIG 2SR

Step 5: Installing the Short Rear Bottom Foam to the Cover

Identify the short rear bottom foam pieces as shown in Fig 2SR at left.

Lay the short bottom piece of foam, with the tape side down, on each of the long legs starting at the bottom of the leg, just under the short top pieces installed in step four. Make sure that the foam is centered on the fabric. Lift the foam up enough to remove the protective strip from the adhesive and press the foam firmly into place on the fabric.



Note: Driver Rear Seatbelt hole cutout not shown.

FIG 5

Step 6: Placing the Sport Bar Cover onto the vehicle

This step will be easier with an extra set of hands.

Carefully take the cover with all foam attached and place it on top of the Sport Bar with zippers facing down on the underside of the bars.

Do the same with the rear legs. Make sure the front and rear Horizontal tube cutouts are properly placed and that all 4 front and back seat belt hole cutouts are properly located. See Fig 5

Installation of Sport Bar Covers:

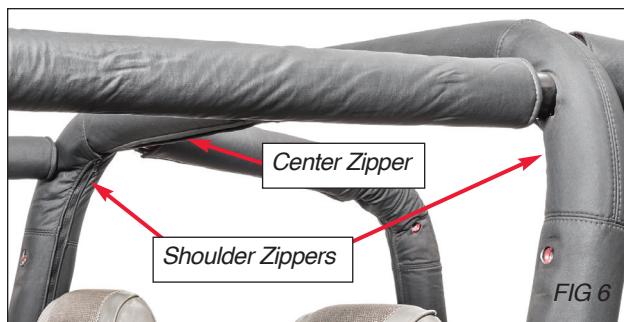

Step 7: Zip Up Top Portion of the Cover

The zippers should be located on the underside of the sport bars. Start the front shoulder zippers 1-2 inches to hold the cover in place. Zip closed the center hoop section then zip up the remaining front shoulder zippers on each side.

Make sure that the fabric is centered on the bar. The fabric and foam should fit snugly around the Sport bar. When zipping, make sure the foam does not interfere with the zipping process. See Fig 6

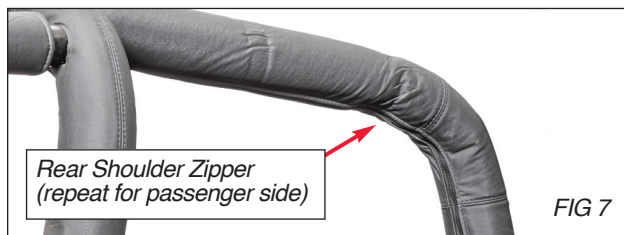

Step 8: Zip Up Long Rear Legs of the Cover

Close the zipper on the shoulders of the rear legs.

Then zip the bottom of the rear leg closed. Make sure that the fabric is centered on the bar. The fabric and foam should fit snugly around the Sport bar. When zipping, make sure the foam does not interfere with the zipping process. See Fig 7



Step 9: Zip Up Horizontal Tube Covers

Place a fabric covered foam tube onto each of the horizontal bars. Orient the tubes so that the zipper closes from front to back. Once the tube is in place and zipped closed, tuck the extension of the zipper into the end of the Horizontal cover. See Fig 8



Step 10: Re-install Seat Belt Bolts

Using a #50 Torx bit and socket driver, re-install the seat belt bolts on the front and rear Sport bars (4 total). See Figs 9 & 10. Make sure these bolts are completely tight and secure. Replace the Bolt cap over the bolt head.

WARNING

You must re-install your Seat belts, front and rear into the Sport Bar upon completion of the cover installation. Failure to do so may cause severe injury or death if you are in an accident. The seat belt bolts must be tightened until you can no longer turn the bolt. Never leave these bolts partially tightened.

*Sport Bar Covers
for Later 92-95
Wrangler YJ*



Care and Maintenance of your MasterTop Sport Bar Covers:

Your MasterTop Sport Bar Cover is made of the finest materials available but to keep it looking new and for the maximum possible wear, it will need periodic cleaning and basic maintenance. The main threat to your soft top is pollutants, dirt and grime. By keeping your cover clean you will prolong the life of your purchase.

We recommend the following to keep your top like new:

Washing:

The cover fabric should be washed often using a mild soap, warm water and a soft bristle brush. You can also use special soft top cleaners available on our Distributors websites. Make sure that after cleaning you rinse with clear water to remove all traces of soap to avoid residue. Air Dry. Do not put in dryer.

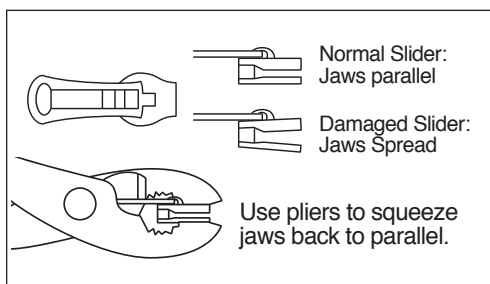

Zippers:

Keeping the zipper cleaned and lubricated with a silicone lubricant (available online) will help prevent damage and keep the zippers in a smooth working condition. If zipper opens behind the slider, the slider may have been spread apart. This problem can usually be fixed by using an ordinary pair of pliers to bring the sides back into parallel. Return slider to the end of the zipper in the normal Open position. Squeeze lightly at first and test zipper. If the zipper continues to remain open squeeze more firmly with pliers and try the zipper again. Repeat procedure until your zipper operates correctly.

For more information on MasterTop:

This and other helpful product information is available on www.mastertop.com
Please visit our website frequently for product updates and exciting news.





Other Summer Soft Tops & Accessories

Introducing MasterTop®

High Quality Soft Accessories Custom Made for Jeep® Wrangler!

MasterTop is the most exciting new entry into the Jeep® accessories market with a wide assortment of superior quality products designed to maximize your Jeep experience. MasterTop is unlike existing companies who have switched to imported materials of average quality for their products to increase profits while subtracting real value. Savvy Jeepers have noticed. Starting in the summer of 2016 MasterTop was created to counter this negative trend and offer modern Jeep Wrangler owners only highest quality products, sold through select Jeep accessory retailers. Based in Golden, Colorado, MasterTop's staff has decades of experience in both original equipment and Jeep aftermarket manufacturing and product development. This expertise combined with North American manufacturing and using only the finest materials make MasterTop the new standard for knowledgeable Jeepers.



The MasterTop Quality Commitment:

- Every MasterTop Summer Accessory has been engineered to ensure the best fit and performance of any product on the market today.
- Only MasterTop Black Diamond Summer Accessories use heavy duty 28oz OEM Approved Sail Cloth material.
- MasterTop fabric Summer Accessories use only original equipment approved fabrics in their construction*.

**Excludes Mesh products for which there is no OEM approved standard.*

MasterTop Summer Soft Tops Include:

-  EASY ON/EASY OFF DESIGN
-  GRAB HANDLE FRIENDLY DESIGN
-  NO DRILL INSTALLATION
-  DURABLE OEM APPROVED TOP FABRICS
-  PROUDLY CONSTRUCTED IN NORTH AMERICA
-  INSTALLATION REQUIRES USE OF A NO DRILL WINDSHIELD HEADER CHANNEL



ShadeMaker™ Mesh Tops



Complete product line available for all Jeep Wrangler 1987-2017

For more information and updates
visit mastertop.com





Limited 3 Year Warranty

Your MasterTop® accessory is covered by the following Limited Warranty provided exclusively by MasterTop, Inc., 420 J Corporate Circle, Golden, CO 80401.

This Limited Warranty is the only warranty made in connection with your purchase. MasterTop neither assumes nor authorizes any vendor, retailer or other person or entity to assume for it any other obligation or liability in connection with this product or Limited Warranty. This Limited Warranty does not apply and is not cumulative to any accessory or part distributed by any MasterTop distributor for which the Manufacturer provides a separate written warranty.

What is Covered: Subject to the terms, exclusions and limitations herein and with respect only to MasterTop branded accessories first sold in the United States, MasterTop warrants to the initial retail purchaser only that your MasterTop accessory shall be free of defects in material and workmanship; **for a period of 3 years from date of initial retail sale.**

All other warranties are hereby disclaimed, except to the extent prohibited by applicable law in which case any implied warranty of merchantability or fitness for a particular purpose on this product is **limited to 3 years from date of initial retail sale.** MasterTop reserves the rights to: (a.) require invoice or other proof your product is within the terms of this Limited Warranty as a condition of warranty service and, (b.) make future revisions to this product and Limited Warranty without prior notice or obligation to upgrade your product.

What is Not Covered: Your MasterTop Limited Warranty does not cover products or parts MasterTop determines to have been damaged by or subjected to: (a.) installation damage, alteration, modification, failure to maintain or attempted repair or service by anyone not authorized by MasterTop, (b.) normal wear and tear, cosmetic damage or damage from water immersion, (c.) Acts of God, accidents, misuse, negligence, inadequate mounting or impact with vehicle(s), obstacles or other aspects of the environment, (d.) theft, vandalism or other intentional damage, (e.) fleet, rental or commercial use, (f.) use in competition or racing.

Remedy Limited to Repair/Replacement: The exclusive remedy provided hereunder shall, upon MasterTop inspection and at MasterTop's option, be either repair or replacement of product or parts (new or refurbished) covered under this Limited Warranty. Customers requesting warranty consideration on MasterTop Products should first contact MasterTop to obtain a RGA number (720-575-5440). All labor, removal, shipping and installation costs are customer's responsibility.

Other Limitations - Exclusion of Damages - Your Rights Under State Law:

In consideration of the purchase price paid, neither MasterTop nor any independent MasterTop distributor /licensee are responsible for any time loss, rental costs, or for any incidental, consequential, punitive or other damages you may have or incur in connection with any part or product purchased. Your exclusive remedy hereunder for covered parts is repair/replacement as described above.

This Limited Warranty gives you specific rights. You may also have other rights that vary from state to state. For example, some states do not allow limitations of how long an implied warranty lasts and/or do not allow the exclusion or limitation of incidental or consequential damages, so the limitations and exclusions herein may not apply to you.

©MasterTop, Inc. 2017. All Rights Reserved. The term MasterTop® is a Registered Trademark of MasterTop Incorporated, Registered in U.S. Patent and Trademark Office.

www.MasterTop.com

Part #941012.01 Version 8.08.17 LTR

