

7929 Lincoln Ave. Riverside, CA 92504  
 Phone: 951.689.ICON | Fax: 951.689.1016

PART #	DESCRIPTION
48500DJ	21-UP BRONCO BILLET UCA DJ PRO KIT

COMPONENTS INCLUDED	
(1) 147000 BRONCO BILLET UCA DRIVER (1) 147001 BRONCO BILLET UCA PASSENGER	(2) 297165 DELTA PRO BILLET UCA DUST COVER
HARDWARE INCLUDED	
(2) 147019 21 BRONCO UCA SPACER SHORT (2) 147020 21 BRONCO UCA SPACER LONG (4) 297010 HEIM SPACER JM12 TO 14MM X 1.875 X 1.47 CZINC	(8) 605002 6-32 X 0.500 SHCS 18-8 RAW (8) 605145 3/8-16 X 1.000 12 PT FLANGED CAP SCREW GR8 CZINC (1) 605968 VIBRATITE BLUE 2ML BULLET
TOOLS REQUIRED	
JACK JACK STANDS RATCHETS EXTENSIONS PHILLIPS SCREWDRIVER BODY CLIP REMOVAL TOOL TORQUE WRENCH	3/8 12-PT 8MM SOCKET / WRENCH 10MM SOCKET / WRENCH 18MM SOCKET / WRENCH 21MM SOCKET / WRENCH 24MM SOCKET / WRENCH
TECH NOTES	
<p>1. ALL ICON UPPER CONTROL ARMS HAVE BEEN ENGINEERED TO ALLOW FOR THE MOST POSSIBLE CASTER, WHILE STILL ALLOWING THE VEHICLE TO BE PROPERLY ALIGNED. NOTIFY YOUR PROFESSIONAL ALIGNMENT SHOP OF THIS INFORMATION SO THAT MAXIMUM RIDE QUALITY CAN BE ACHIEVED.</p> <p>2. ICON DELTA JOINTS ARE PRE-GREASED FROM THE FACTORY. ICON RECOMMENDS GREASING THE DELTA JOINT EVERY 3,000 MILES (OR EVERY OIL CHANGE). ADD NEW GREASE UNTIL ALL OF THE OLD GREASE IS EXPELLED FROM THE BOTTOM OF THE DELTA JOINT ASSEMBLY, WIPE AWAY EXCESS WITH A RAG OR SHOP TOWEL.</p> <p>3. DO NOT EXCEED 1.875" ADJUSTMENT FROM THE CENTER OF THE ROD END TO THE EDGE OF THE BILLET UPPER CONTROL ARM. FAILURE CAUSED BY EXCESSIVE ADJUSTMENT WILL NOT BE COVERED UNDER ICON'S WARRANTY POLICY. REFER TO TECH NOTE PHOTO ON PAGE 3.</p>	

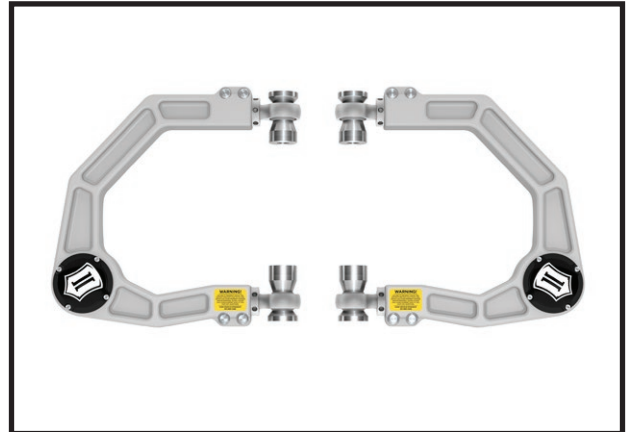

WARNING!
<p>** READ ALL INSTRUCTIONS THOROUGHLY FROM START TO FINISH BEFORE BEGINNING INSTALLATION! IF THESE INSTRUCTIONS ARE NOT PROPERLY FOLLOWED SEVERE FRAME, SUSPENSION AND TIRE DAMAGE MAY RESULT TO THE VEHICLE!</p> <p>** ICON VEHICLE DYNAMICS RECOMMENDS THAT YOU EXERCISE EXTREME CAUTION WHEN WORKING UNDER A VEHICLE THAT IS SUPPORTED WITH JACK STANDS.</p> <p>** ICON VEHICLE DYNAMICS RECOMMENDS ALL INSTALLATION TO BE PERFORMED BY A PROFESSIONAL SHOP/SERVICE TECHNICIAN. PRODUCT FAILURE CAUSED BY IMPROPER INSTALLATION WILL NOT BE COVERED UNDER ICON'S WARRANTY POLICY.</p>

## INSTALLATION

- Lift vehicle and securely place heavy duty jack stands under the manufacturer recommended lifting locations for the front of the vehicle. Take care when lifting the vehicle, and allow 3-4" of ground clearance from the tire. Remove front tires. NEVER WORK UNDER AN UNSUPPORTED VEHICLE. Remove the wheels.
- Remove fender line for easier access to bolts. (UCA removal and installation can be done without removing the fender liner) Four 7mm screws holding the liner to the fender. 14 phillips push pins spread through the rest of the liner. Apply pressure behind the pin while unscrewing the plastic screw. Once the screw is out, pull the rest of the pin assembly out. [FIGURE 1]

FIG.1



**3.** On Driver side only, disconnect the steering shaft coupler. Remove the 10mm bolt and push the black grooved shaft into the body. Before removal, make sure the steering wheel is straight. Do not turn steering while disconnected. [FIGURE 2 & 3]

FIG.2

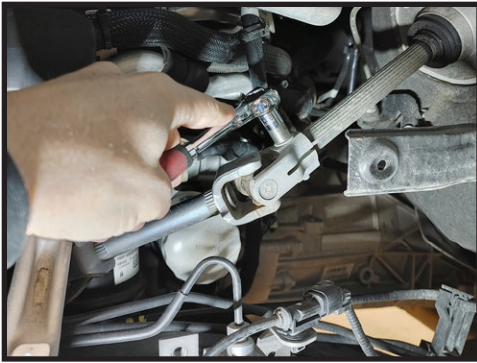
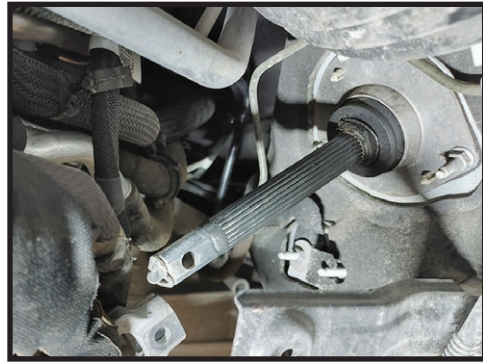

FIG.3



**4.** On passenger side of 4 cylinder models, remove the heatshield using an 8mm. [FIGURE 4]

FIG.4



**5.** Remove balljoint from the spindle using an 18mm, leave the nut on loosely. To free the taper from the spindle, a hammer or balljoint separator can be used. [FIGURE 5]

FIG.5



**6.** Support the spindle so the CV joints do not overextend and remove the balljoint nut.

**7.** Loosen and remove the UCA pivot bolt from the frame, using a 21 and 24 mm. remove the UCA.

**8.** Before installing the ICON billet UCA, make sure the heim spacers are correctly installed (Driver side shown). [FIGURE 6]

FIG.6



**9.** Install UCA using the factory pivot bolt and torque to factory specs.

**10.** Install delta joint into the spindle using the supplied 21mm nylock nut and torque to 75 ft-lbs. **[FIGURE 7]**

**FIG.7**



**11.** Reconnect the steering shafts. Apply a small amount of blue thread locker to the bolt and torque to factory specs.

**12.** Reinstall the heatshield on passenger side, if applicable.

**13.** Reinstall the fender liner if removed.

**14.** Reinstall wheels and tires, lower vehicle to ground and get professionally aligned.

#### **ALIGNMENT NOTE**

*ICON SHIPS THE BILLET UPPER CONTROL ARM AT THE MOST COMMON ALIGNMENT SETTING. ONE OF THE MAJOR PERFORMANCE ADVANTAGES OF AN ICON BILLET ADJUSTABLE UPPER CONTROL ARM IS THE ABILITY TO IMPROVE WHEEL POSITION. IMPROVING WHEEL POSITION IMPROVES FIREWALL CLEARANCE ALLOWING FOR LARGER TIRES AS THE SUSPENSION CYCLES. IN ORDER TO TAKE ADVANTAGE OF THIS FEATURE, DISCUSS WITH YOUR PROFESSIONAL ALIGNMENT SHOP THAT YOU WOULD LIKE TO CAM THE LOWER CONTROL ARM TO MAXIMIZE WHEEL POSITION FORWARD AND THEN ADJUST CAMBER AND CASTER WITH THE UPPER THREADED ADJUSTERS.*

*A MAJOR PERFORMANCE ADVANTAGE OF ALL ICON UPPER CONTROL ARMS IS INCREASED CASTER OVER STOCK. DISCUSS WITH A PROFESSIONAL ALIGNMENT SHOP THAT YOU WANT THE VEHICLE ALIGNED WITH THE CASTER AT THE MAX OF THE FACTORY RECOMMENDED SETTINGS IF YOU WANT TO TAKE ADVANTAGE OF THE DYNAMIC EFFECTS OF INCREASED CASTER.*

#### **[TECH NOTE #3]**



***VERIFY ALL FASTENERS ARE PROPERLY TORQUED BEFORE DRIVING VEHICLE.***

***RETORQUE ALL NUTS, BOLTS AND LUGS AFTER 100 MILES AND PERIODICALLY THEREAFTER.***

## ICON VEHICLE DYNAMICS LIMITED LIFETIME WARRANTY

ICON Vehicle Dynamics warrants to the original retail purchaser who owns the vehicle on which the product was originally installed. ICON Vehicle Dynamics does not warrant the product for finish, alterations, modifications and/or installation contrary to ICON Vehicle Dynamics instructions. ICON Vehicle Dynamics products are not designed, nor are they intended to be installed on vehicles used in race applications, for racing purposes or for similar activities. (A "race" is defined as any contest between two or more vehicles, or a contest of one or more vehicles against the clock, whether or not such contest is for a prize). This warranty does not include coverage for police or taxi vehicles, race vehicles, or vehicles used for government or commercial purposes. Also excluded from this warranty are sales outside of the United States of America and Canada.

ICON Vehicle Dynamics' obligation under this warranty is limited to the repair or replacement, at ICON Vehicle Dynamics' discretion, of the defective product. Any and all costs of removal, installation or re-installation, freight charges and incidental or consequential damages are expressly excluded from this warranty. Items that are subject to wear are not considered defective when worn and are not covered.

ICON Vehicle Dynamics components must be installed as a complete kit as shown in our current application guide. Any substitutions or exemptions of required components will immediately void the warranty. Some finish damage may happen to parts during shipping and is not covered under warranty.

This warranty is expressly in lieu of all other warranties expressed or implied. This warranty shall not apply to any product that has been improperly installed, modified or customized subject to accident, negligence, abuse or misuse.



**ICON VEHICLE DYNAMICS®**  
PERFORMANCE SUSPENSION SYSTEMS AND SHOCK ABSORBERS

7929 Lincoln Ave. Riverside, CA 92504 Phone: 951.689.ICON Fax: 951.689.1016  
[www.iconvehicledynamics.com](http://www.iconvehicledynamics.com)



**FOLLOW US ON FACEBOOK!**



7929 Lincoln Ave. Riverside, CA 92504  
Phone: 951.689.ICON | Fax: 951.689.1016

PART #	DESCRIPTION
48700	21-UP FORD BRONCO FRONT VS RR COILOVER KIT

### COMPONENTS INCLUDED

(1) 144930RD 21-UP BRONCO FRONT 0-3.5" 2.5 C/O RR UPKG DRIVER	(1) 2500020 7.50 UNIVERSAL RESI MT PLATE OFFSET CZINC
(1) 144930RP 21-UP BRONCO FRONT 0-3.5" 2.5 C/O RR UPKG PASSENGER	(2) 141007 21-UP BRONCO RESI MOUNT
(1) 250002 D 7.50 UNIVERSAL RESI MT PLATE CZINC	(1) 611019 COILOVER HARDWARE KIT
	(1) 611052 COILOVER LOWER HARDWARE KIT
	(1) 611083 BRONCO SWAY BAR DROP KIT

### HARDWARE INCLUDED

(4) 605144 3/8-12 X .750 FLANGED SELF TAP BOLT CZINC	(4) 611051 #36 1.188-2.750 STAINLESS HOSE CLAMP KIT
611019 COILOVER HARDWARE KIT	
(6) 605101 3/8-16 X 1.000 HHCS GR8 YZINC	(6) 605131 3/8 SPLIT LOCK WASHER GR8 YZINC
611052 COILOVER LOWER HARDWARE KIT	
(4) 605205 7/16-14 X 2.750 HHCS GR8 YZINC	(4) 605231 WASHER 1.00 X .469 X .125 BOXIDE
(4) 605230 7/16 SAE FLAT WASHER GR8 YZINC	
611083 BRONCO SWAY BAR DROP KIT	
(2) 147042 SWAY BAR SPACER	(4) 605749 7/16-14 X .750 HHCS GR8 YZINC
(2) 290025 WASHER 1" X .505" X .375"	(4) 605918 M12 X 1.75" X 30MM BHCS ZINC
(4) 605230 7/16 SAE FLAT WASHER GR8 YZINC	(1) 605968 VIBRATITE BLUE 2ML BULLET

### TOOLS REQUIRED

JACK	6MM HEX KEY
JACK STANDS	8MM SOCKET / WRENCH
TORQUE WRENCH	10MM SOCKET / WRENCH
RATCHET	15MM SOCKET / WRENCH
EXTENSIONS	18MM SOCKET / WRENCH
5/16" SOCKET / WRENCH	21MM SOCKET / WRENCH
9/16" SOCKET / WRENCH	22MM SOCKET / WRENCH
5/8" SOCKET / WRENCH	24MM SOCKET / WRENCH

### TECH NOTES

1. YOUR ICON COILOVER ASSEMBLIES COME FACTORY CHARGED TO 150 PSI. RELEASING NITROGEN PRESSURE MAY LEAD TO SHOCK MALFUNCTION AND REDUCED RIDE QUALITY. FAILURE CAUSED BY LOW NITROGEN PRESSURE IS NOT COVERED UNDER ICON'S WARRANTY POLICY.
2. YOUR ICON COILOVER ASSEMBLIES COME SHIPPED AT ICON'S RECOMMENDED RIDE HEIGHT. REDUCING DROOP TRAVEL WILL REDUCE RIDE QUALITY. DO NOT PRELOAD THE COIL BEYOND 2.6" OF EXPOSED THREADS BETWEEN THE BOTTOM OF THE TOP CAP AND THE TOP OF THE COIL ADJUSTER NUT. ADJUSTING PRELOAD BEYOND THIS SETTING WILL CAUSE THE COIL TO BIND AND DAMAGE WILL OCCUR TO COILOVER AND/OR VEHICLE.
3. ESTIMATED INSTALL TIME: 4-5 HOURS.



### WARNING!

**\*\* READ ALL INSTRUCTIONS THOROUGHLY FROM START TO FINISH BEFORE BEGINNING INSTALLATION! IF THESE INSTRUCTIONS ARE NOT PROPERLY FOLLOWED SEVERE FRAME, SUSPENSION AND TIRE DAMAGE MAY RESULT TO THE VEHICLE!**

**\*\* ICON VEHICLE DYNAMICS RECOMMENDS THAT YOU EXERCISE EXTREME CAUTION WHEN WORKING UNDER A VEHICLE THAT IS SUPPORTED WITH JACK STANDS.**

**\*\* ICON VEHICLE DYNAMICS RECOMMENDS ALL INSTALLATION TO BE PERFORMED BY A PROFESSIONAL SHOP/SERVICE TECHNICIAN. PRODUCT FAILURE CAUSED BY IMPROPER INSTALLATION WILL NOT BE COVERED UNDER ICON'S WARRANTY POLICY.**

## INSTALLATION

**1.** Lift vehicle and securely place heavy duty jack stands under the manufacturer recommended lifting locations for the front of the vehicle. Take care when lifting the vehicle, and allow 3-4" of ground clearance from the tire. Remove front tires. NEVER WORK UNDER AN UNSUPPORTED VEHICLE. Remove the wheels.

**2.** Disconnect sway bar from both lower control arms using a 6mm and 21mm wrench. Rotate sway bar and links up away from the lower arm. [FIGURE 1]



FIG.1

**3.** Remove the sway bar skid plate to gain access to the sway bar brackets (4 x 15mm bolts). [FIGURE 2]

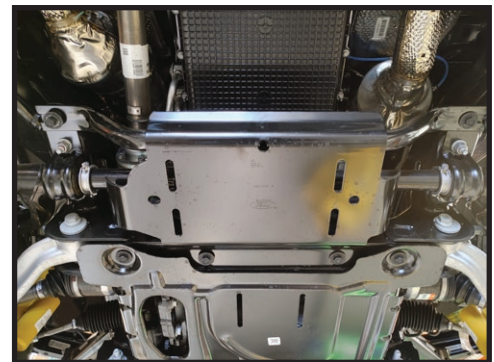
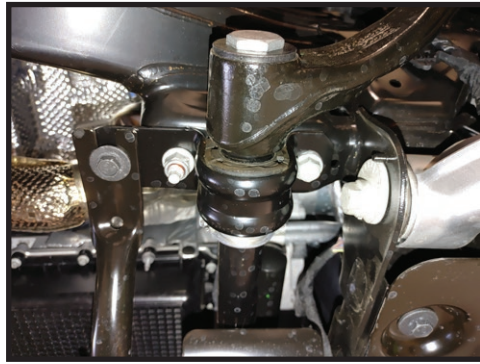

FIG.2

4. Remove one side of the sway bar from the frame to gain access to the lower control arm bolts (18mm). [FIGURE 3]

FIG.3



5. Support the lower control arm and remove the bolts from the frame. Remove the 15mm nuts from the top of the coilover. [FIGURE 4]

FIG.4



6. Remove the 18mm nuts from the bottom of the coilover. [FIGURE 5]

FIG.5



7. Lower the arm down so the coilover can be removed. [FIGURE 6]

FIG.6

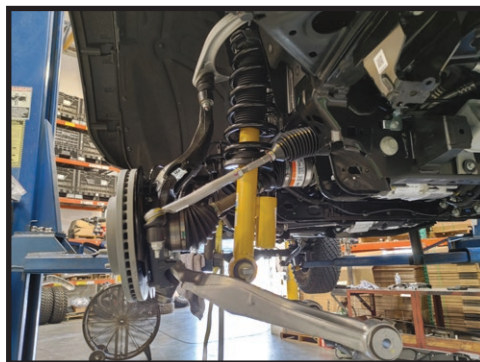

**8.** With the factory coilover removed, install the ICON coilover. Upper mount first using the supplied 3/8-16 x 1.00 GR8 bolts and split lock washers. Torque to 35 ft-lbs using a 9/16. [FIGURE 7]

FIG.7



**9.** Reinstall the lower control arm into the frame pockets using factory hardware (snug bolts only) and connect the lower shock to the control arm using the supplied 7/16 bolts and washers. Torque to 70 ft-lbs. Refer to the photo for proper bolt/washer orientation. [FIGURE 8]

FIG.8

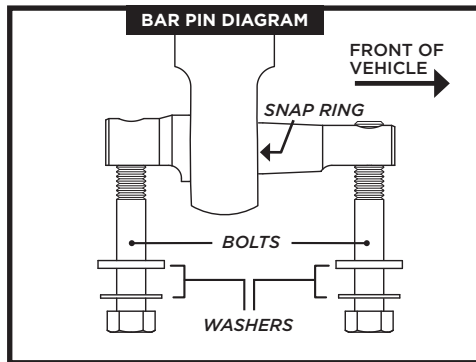

**10.** Install the sway bar relocation brackets now before reinstalling the sway bar.

**11.** Remove the stud from each side using an 8mm. [FIGURE 9]

FIG.9



**12.** Install the ICON sway bar relocation bracket using the supplied 12mm socket head bolts using an 8mm hex key. Apply thread locker to the bolts. Make sure the threaded holes in the relocation bracket are towards the back of the truck. Torque to 55 ft-lbs. [FIGURE 10]

FIG.10



**13.** Using the supplied 7/16 x 3/4 bolts and washer (apply thread locker) install the sway bar back into place. Torque bolts to 50 ft-lbs using a 5/8. [FIGURE 11]

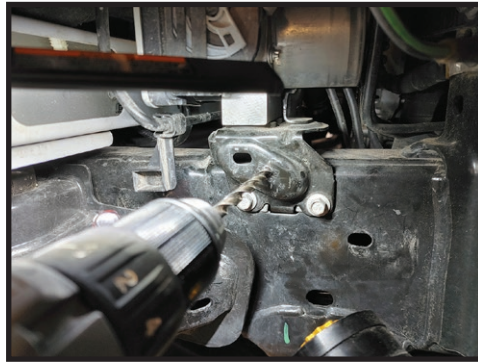

**FIG.11**

**14.** For models with the electronic disconnect sway bar, reinstall the factory skid plate with the supplied washers between the frame cross member and skid plate. The rear will bolt back to the sway bar bracket like factory.

**15.** For remote reservoir coilovers on 4-cylinder models:

- a. Remove the lower rubber fender liner and move the fabric fender liner out of the way to gain access to the ABS control module. Complete removal of fender liner can make install easier. Four 7mm screws and 14 phillips push pins retain the liner.
- b. Drill a 5/16 hole into the ABS bracket as shown. [FIGURE 12]



**FIG.12**

**16.** Install the 250002 bracket as shown using one 3/8" self tapping bolt. [FIGURE 13]



**FIG.13**

**17.** Passenger side install on 4 cylinder models. Remove the lower rubber fender line and move the fabric liner out of the way. Remove the rear 10mm bolt that holds the heater lines. Place the 2500020 bracket in position and reinstall factory bolt, as shown. Use supplied hose clamps to secure reservoir to brackets. [FIGURE 14 & 15]

FIG.14

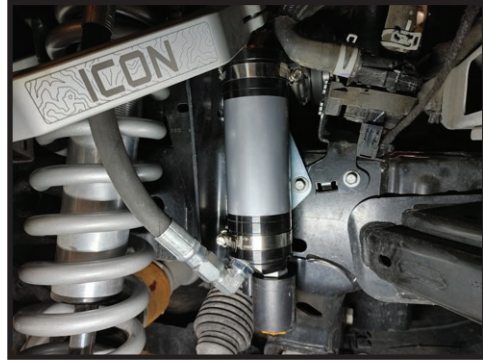

FIG.15

**18.** Cut and trim the fender liner as needed to show off your new reservoirs.

**19.** On V6 models, remove the rubber fender liner and move the fabric line out of the way. Using a 5/16" drill bit, drill 2 holes and mount the supplied reservoir bracket as shown. Use supplied hose clamps to secure reservoir. Cut and trim the fender liners as needed to show off your new reservoirs. [FIGURE 16 & 17]

FIG.16



FIG.17

**20.** Make sure all bolts and nuts are tight. Install wheels and tires.

**21.** Lower vehicle to the ground and tighten the lower control arm pivot bolts.

**22.** Get vehicle professionally aligned.

***VERIFY ALL FASTENERS ARE PROPERLY TORQUED BEFORE DRIVING VEHICLE.***

***RETORQUE ALL NUTS, BOLTS AND LUGS AFTER 100 MILES AND PERIODICALLY THEREAFTER.***

## 2.5 VS SERIES SHOCK & COILOVER TECHNICAL INFORMATION

### MAINTENANCE

ICON shock absorbers are a high quality rebuildable race style shock absorber designed for optimal performance. With a unit of this caliber on your vehicle, routine maintenance is required to keep them looking and operating in like new condition. Residual oil and assembly lube may be present at all seal paths from the factory out of the box and is considered normal. Pooling of oil however is not acceptable at any time and one should contact the ICON dealer where purchased.

**BELOW ARE GUIDELINES BASED ON HOW YOU USE YOUR VEHICLE BUT YOUR MILEAGE MAY VARY:**

#### **STREET USE:**

- Send in for factory servicing every 40,000 miles or if a leak develops, ride quality decreases, or they begin to make excessive noise.
- Remove any buildup of road salt, mud, or debris from shocks and coil springs anytime accrued
- Clean with mild soap and water with each oil change or anytime you notice build up.
- Wax the cylinders yearly with automotive wax to prevent corrosion.
- Check nitrogen pressure yearly. (252004 charge needle assembly available at any ICON distributor)
- Check bearings for excessive wear yearly.
- DO NOT apply any type of lube to the upper and lower bearings.

#### **STREET/DIRT:**

- Send in for factory servicing every 15,000 miles or if a leak develops, ride quality decreases, or they begin to make excessive noise.
- Clean with mild soap and water with each oil change, offroad trip, or anytime you notice build up.
- Wax the cylinders yearly with automotive wax to prevent corrosion.
- Check nitrogen pressure each dirt outing. (252004 charge needle assembly available at any ICON distributor)
- Check bearings for excessive wear yearly.
- DO NOT apply any type of lube to the upper and lower bearings.

#### **DIRT USE:**

- Send in for factory servicing every 1,000 miles.
- Check nitrogen pressure each outing. (252004 charge needle assembly available at any ICON distributor)
- Remove any buildup of mud or debris from shocks and coil springs after every outing.

#### **SELF-SERVICE:**

- Contact ICON for service kits & tools at (951) 689-4266.

### PRODUCT REGISTRATION

Please visit: <http://www.iconvehicledynamics.com/tech-support/registration/> to register your product.

### ICON VEHICLE DYNAMICS SHOCK ABSORBER WARRANTY

This shock absorber has a 1 year warranty against any manufacturer's defects. If a shock fails within the initial year of ownership, the shock must be shipped to ICON Vehicle Dynamics for inspection and service. If a shock is inspected and it has been determined the shock failed due to neglect, damage caused by improper installation or any other reason besides "normal wear and tear", the owner of said shock is responsible for all service costs. This includes labor, parts, and shipping.

ICON Vehicle Dynamics warrants to the original retail purchaser who owns the vehicle on which the product was originally installed. ICON Vehicle Dynamics does not warrant the product for finish, alterations, modifications and/or installation contrary to ICON Vehicle Dynamics instructions. ICON Vehicle Dynamics products are not designed, nor are they intended to be installed on vehicles used in race applications, for racing purposes or for similar activities. (A "race" is defined as any contest between two or more vehicles, or a contest of one or more vehicles against the clock, whether or not such contest is for a prize). This warranty does not include coverage for police or taxi vehicles, race vehicles, or vehicles used for government or commercial purposes. Also excluded from this warranty are sales outside of the United States of America and Canada.

ICON Vehicle Dynamics' obligation under this warranty is limited to the repair or replacement, at ICON Vehicle Dynamics' discretion, of the defective product. Any and all costs of removal, installation or re-installation, freight charges and incidental or consequential damages are expressly excluded from this warranty. Items that are subject to wear are not considered defective when worn and are not covered.

ICON Vehicle Dynamics components must be installed as a complete kit as shown in our current application guide. Any substitutions or exemptions of required components will immediately void the warranty. Some finish damage may happen to parts during shipping and is not covered under warranty.

This warranty is expressly in lieu of all other warranties expressed or implied. This warranty shall not apply to any product that has been improperly installed, modified or customized subject to accident, negligence, abuse or misuse.

To send a shock in for warranty please visit our website <http://www.iconvehicledynamics.com/tech-support/shock-service/>



**ICON VEHICLE DYNAMICS®**  
PERFORMANCE SUSPENSION SYSTEMS AND SHOCK ABSORBERS

7929 Lincoln Ave. Riverside, CA 92504 Phone: 951.689.ICON Fax: 951.689.1016  
[www.iconvehicledynamics.com](http://www.iconvehicledynamics.com)



**FOLLOW US ON FACEBOOK!**



7929 Lincoln Ave. Riverside, CA 92504  
 Phone: 951.689.ICON | Fax: 951.689.1016

PART #	DESCRIPTION
48711	21-UP BRONCO REAR 2.5 VS RR COILOVER KIT HEAVY RATE SPRING

COMPONENTS INCLUDED	
(1) 144932RD 21-UP BRONCO REAR RR C/O 2.5 VS DRV Heavy Rate Spring (1) 144932RP 21-UP BRONCO REAR RR C/O 2.5 VS PASS Heavy Rate Spring	(1) 611051 #36 1.188-2.750 STAINLESS HOSE CLAMP KIT (4)
HARDWARE INCLUDED	
(1) 140001 21-UP BRONCO STUD PLATE, REAR UPPER (1) 140002 21-UP BRONCO REAR RESI MOUNT DRV (1) 140003 21-UP BRONCO REAR RESI MOUNT PASS (2) 144005 21-UP BRONCO REAR RESI NUT PLATE (1) 147010 21-UP BRONCO UPPER REAR C/O MOUNT (4) 257172 HEIM SPACER COM12 X .500 X 1.250 CZINC	(4) 257194 HEIM SPACER COM14 X 20MM X 85MM CZINC (4) 605053 1/4 SAE FLAT WASHER GR8 YZINC (2) 605202 7/16-14 X 1.250 HHCS GR8 YZINC (2) 605334 1/2-13 X 2.250 12 PT FLANGED CAP SCREW BLK ZINC (4) 605876 1/4-20 X 1 HHCS GR8 YZINC (4) 605881 M12-1.50 NYLOCK FLANGE NUT CZINC (1) 605970 VIBRATITE ANTI SEIZE INDIVIDUAL USE TUBE
TOOLS REQUIRED	
JACK JACK STANDS RATCHET, EXTENSIONS TORQUE WRENCH #2 PHILLIPS SCREWDRIVER FLAT HEAD SCREWDRIVER BODY PANEL CLIP REMOVAL TOOL GRINDER/SANDER (OPTIONAL)	5/16" SOCKET / WRENCH 7/16" SOCKET / WRENCH 1/2 12PT SOCKET / WRENCH 5/8 SOCKET / WRENCH 15MM SOCKET / WRENCH 18MM SOCKET / WRENCH 27MM SOCKET / WRENCH
TECH NOTES	
<p>1. YOUR ICON COILOVER ASSEMBLIES COME FACTORY CHARGED TO 150 PSI. RELEASING NITROGEN PRESSURE MAY LEAD TO SHOCK MALFUNCTION AND REDUCED RIDE QUALITY. FAILURE CAUSED BY LOW NITROGEN PRESSURE IS NOT COVERED UNDER ICON'S WARRANTY POLICY.</p> <p>2. YOUR ICON COILOVER ASSEMBLIES COME SHIPPED AT ICON'S RECOMMENDED RIDE HEIGHT. REDUCING DROOP TRAVEL WILL REDUCE RIDE QUALITY. DO NOT PRELOAD THE COIL BEYOND 5.75" OF EXPOSED THREADS BETWEEN THE BOTTOM OF THE TOP CAP AND THE TOP OF THE COIL ADJUSTER NUT. ADJUSTING PRELOAD BEYOND THIS SETTING WILL CAUSE THE COIL TO BIND AND DAMAGE WILL OCCUR TO COILOVER AND/OR VEHICLE.</p> <p>3. RESERVOIR HOSE CLAMPS CAN BE PURCHASED FOR FACTORY TUBE LINKS, ICON TUBE LINKS OR COME STANDARD WITH ICON BILLET LINKS.</p> <p>4. SPRING OPTION DIAGRAM ON PAGE 5.</p> <p>5. ESTIMATED INSTALL TIME: 3-5 HOURS.</p>	



WARNING!
<p><b>** READ ALL INSTRUCTIONS THOROUGHLY FROM START TO FINISH BEFORE BEGINNING INSTALLATION! IF THESE INSTRUCTIONS ARE NOT PROPERLY FOLLOWED SEVERE FRAME, SUSPENSION AND TIRE DAMAGE MAY RESULT TO THE VEHICLE!</b></p> <p><b>** ICON VEHICLE DYNAMICS RECOMMENDS THAT YOU EXERCISE EXTREME CAUTION WHEN WORKING UNDER A VEHICLE THAT IS SUPPORTED WITH JACK STANDS.</b></p> <p><b>** ICON VEHICLE DYNAMICS RECOMMENDS ALL INSTALLATION TO BE PERFORMED BY A PROFESSIONAL SHOP/SERVICE TECHNICIAN. PRODUCT FAILURE CAUSED BY IMPROPER INSTALLATION WILL NOT BE COVERED UNDER ICON'S WARRANTY POLICY.</b></p>

**2.** Remove Fender flare. Turn the 1/4 turn fasteners counter clockwise to release the flare. Then pull on flare and it will pop off the vehicle.

**3.** Remove inner fender liner. There are 10 plastic phillip head screw clips, 3 small phillip screws, 1 (driver side), 2 (passenger side) wing nuts to remove. [FIGURE 1 & 2]

## INSTALLATION

**1.** Lift vehicle and securely place heavy duty jack stands under the manufacturer recommended lifting locations for the front of the vehicle. Take care when lifting the vehicle, and allow 3-4" of ground clearance from the tire. Remove front tires. NEVER WORK UNDER AN UNSUPPORTED VEHICLE. Remove the wheels.

FIG.1



FIG.2



4. Support the rear axle. Remove upper shock mount nuts (15mm). [FIGURE 3]

FIG.3



5. Remove lower shock bolt and nut using a 27mm and remove the factory coilover. [FIGURE 4]

FIG.4



6. Install the upper mount and stud plate as shown, the stud plate installs from under the frame mount, and the upper mount installed on top of the frame with the 2 studs/nuts accessible from the wheel well and the 7/16" bolt towards the inside (Driver side shown). Torque the 7/16 bolt to 65 ft-lbs. Torque the 12mm nuts to 65 ft-lbs. [FIGURE 5 & 6]

FIG.5



FIG.6



7. Install the reservoir mount to the frame above the lower link pivot. Use the supplied 1/4" nut plate and 1/4" bolts and washers. Grind any high spots in the factory weld to allow the reservoir mount to sit flush against the frame. [FIGURE 6 & 7]

FIG.6

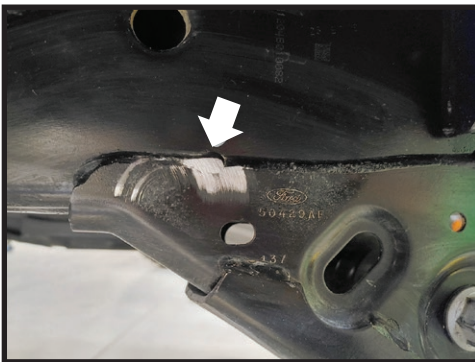

FIG.7



**8.** On the reservoir mount, mark the front hole and drill the frame to 7/32 then use the 1/4" self-tapping bolt to secure the front of the mount to the frame. [FIGURE 8 & 9]

FIG.8



FIG.9



**9.** Install the Icon coilover into the upper mount with the 257172 spacers and 605334 1/2-13 12pt bolt (Apply a small amount of anti-seize to the spacers and bolt). Torque to 90 ft-lbs with a 1/2" 12pt socket. [FIGURE 10]

FIG.10



**10.** Install lower shock eyelet with 257194 spacers into the factory mount and torque the bolt to factory spec (Apply a small amount of anti-seize to the spacers before installing them into the rod end). [FIGURE 11]

FIG.11



**11.** Route the hose along the lower control arm and place on top of the reservoir mount, using the supplied stainless steel hose clamps to loosely secure it. Then secure the hose to the lower link with the clamps provided with the billet links, or the clamps purchased for the tube links. If non ICON or factory links are installed, cable ties are the next option. [FIGURE 12 & 13]

FIG.12



FIG.13



**12.** Secure the reservoir hose clamps with the reservoir in the correct position, as shown. [FIGURE 14 & 15]

FIG.14



FIG.15

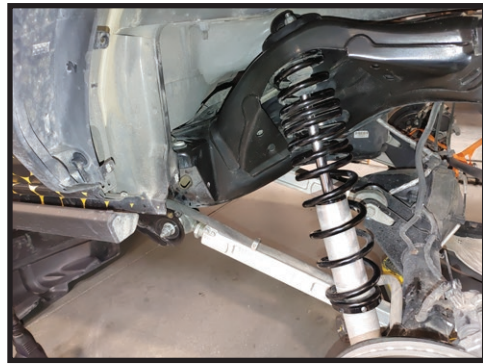

**13.** Repeat steps on passenger side.

**14.** Reinstall wheels/tires. Torque lug nuts. Lower vehicle back to the ground.

***VERIFY ALL FASTENERS ARE PROPERLY TORQUED BEFORE DRIVING VEHICLE.  
RETORQUE ALL NUTS, BOLTS AND LUGS AFTER 100 MILES AND PERIODICALLY THEREAFTER.***

## OPTION 1

1

SPRING INSTALLED  
AT THE  
LOWEST SETTING

IMAGE SHOWN WITH  
OVERLAND SPRING  
INSTALLED WITH NO  
ADDITIONAL WEIGHT



## OPTION 2

2

SPRING SET IN THE  
LOWEST POSITION  
WITH A LEVELED  
STANCE

**150 lbs**  
IN CARGO AREA



## OPTION 3

3

SPRING SET IN THE  
LOWEST POSITION  
WITH A SLIGHTLY  
LOWER REAR

**280 lbs**  
IN CARGO AREA

**520 lbs**  
BACKSEAT



## 2.5 VS SERIES SHOCK & COILOVER TECHNICAL INFORMATION

### MAINTENANCE

ICON shock absorbers are a high quality rebuildable race style shock absorber designed for optimal performance. With a unit of this caliber on your vehicle, routine maintenance is required to keep them looking and operating in like new condition. Residual oil and assembly lube may be present at all seal paths from the factory out of the box and is considered normal. Pooling of oil however is not acceptable at any time and one should contact the ICON dealer where purchased.

**BELOW ARE GUIDELINES BASED ON HOW YOU USE YOUR VEHICLE BUT YOUR MILEAGE MAY VARY:**

#### **STREET USE:**

- Send in for factory servicing every 40,000 miles or if a leak develops, ride quality decreases, or they begin to make excessive noise.
- Remove any buildup of road salt, mud, or debris from shocks and coil springs anytime accrued
- Clean with mild soap and water with each oil change or anytime you notice build up.
- Wax the cylinders yearly with automotive wax to prevent corrosion.
- Check nitrogen pressure yearly. (252004 charge needle assembly available at any ICON distributor)
- Check bearings for excessive wear yearly.
- DO NOT apply any type of lube to the upper and lower bearings.

#### **STREET/DIRT:**

- Send in for factory servicing every 15,000 miles or if a leak develops, ride quality decreases, or they begin to make excessive noise.
- Clean with mild soap and water with each oil change, offroad trip, or anytime you notice build up.
- Wax the cylinders yearly with automotive wax to prevent corrosion.
- Check nitrogen pressure each dirt outing. (252004 charge needle assembly available at any ICON distributor)
- Check bearings for excessive wear yearly.
- DO NOT apply any type of lube to the upper and lower bearings.

#### **DIRT USE:**

- Send in for factory servicing every 1,000 miles.
- Check nitrogen pressure each outing. (252004 charge needle assembly available at any ICON distributor)
- Remove any buildup of mud or debris from shocks and coil springs after every outing.

#### **SELF-SERVICE:**

- Contact ICON for service kits & tools at (951) 689-4266.

### PRODUCT REGISTRATION

Please visit: <http://www.iconvehicledynamics.com/tech-support/registration/> to register your product.

### ICON VEHICLE DYNAMICS SHOCK ABSORBER WARRANTY

This shock absorber has a 1 year warranty against any manufacturer's defects. If a shock fails within the initial year of ownership, the shock must be shipped to ICON Vehicle Dynamics for inspection and service. If a shock is inspected and it has been determined the shock failed due to neglect, damage caused by improper installation or any other reason besides "normal wear and tear", the owner of said shock is responsible for all service costs. This includes labor, parts, and shipping.

ICON Vehicle Dynamics warrants to the original retail purchaser who owns the vehicle on which the product was originally installed. ICON Vehicle Dynamics does not warrant the product for finish, alterations, modifications and/or installation contrary to ICON Vehicle Dynamics instructions. ICON Vehicle Dynamics products are not designed, nor are they intended to be installed on vehicles used in race applications, for racing purposes or for similar activities. (A "race" is defined as any contest between two or more vehicles, or a contest of one or more vehicles against the clock, whether or not such contest is for a prize). This warranty does not include coverage for police or taxi vehicles, race vehicles, or vehicles used for government or commercial purposes. Also excluded from this warranty are sales outside of the United States of America and Canada.

ICON Vehicle Dynamics' obligation under this warranty is limited to the repair or replacement, at ICON Vehicle Dynamics' discretion, of the defective product. Any and all costs of removal, installation or re-installation, freight charges and incidental or consequential damages are expressly excluded from this warranty. Items that are subject to wear are not considered defective when worn and are not covered.

ICON Vehicle Dynamics components must be installed as a complete kit as shown in our current application guide. Any substitutions or exemptions of required components will immediately void the warranty. Some finish damage may happen to parts during shipping and is not covered under warranty.

This warranty is expressly in lieu of all other warranties expressed or implied. This warranty shall not apply to any product that has been improperly installed, modified or customized subject to accident, negligence, abuse or misuse.

To send a shock in for warranty please visit our website <http://www.iconvehicledynamics.com/tech-support/shock-service/>



**ICON VEHICLE DYNAMICS®**  
PERFORMANCE SUSPENSION SYSTEMS AND SHOCK ABSORBERS

7929 Lincoln Ave. Riverside, CA 92504 Phone: 951.689.ICON Fax: 951.689.1016  
[www.iconvehicledynamics.com](http://www.iconvehicledynamics.com)



**FOLLOW US ON FACEBOOK!**



7929 Lincoln Ave. Riverside, CA 92504  
Phone: 951.689.ICON | Fax: 951.689.1016

PART #	DESCRIPTION
611072	21-UP BRONCO HOSE ROUTE KIT OEM REAR LINK 1.9"

COMPONENTS INCLUDED	
(2) 147026 21-UP BRONCO, FACTORY LINK HOSE CLAMP	
HARDWARE INCLUDED	
(4) 605073 10-24 X 1.250 SHSS 18-8 RAW	(1) 605989-03 TUBING, BLACK PVC, 1/4" - 3/4" CUT LENGTH
TOOLS REQUIRED	
JACK JACK STANDS	ADJUSTABLE PLIERS 3/32 HEX KEY
TECH NOTES	
1. CLAMPS CAN BE INSTALLED WHILE LINKS ARE INSTALLED ON VEHICLE.	

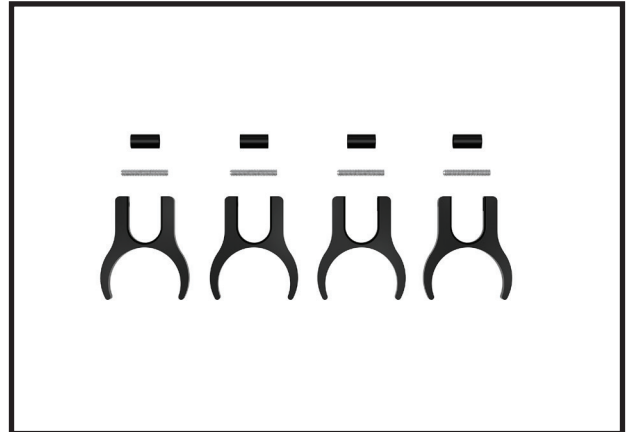

WARNING!
** READ ALL INSTRUCTIONS THOROUGHLY FROM START TO FINISH BEFORE BEGINNING INSTALLATION! IF THESE INSTRUCTIONS ARE NOT PROPERLY FOLLOWED SEVERE FRAME, SUSPENSION AND TIRE DAMAGE MAY RESULT TO THE VEHICLE!
** ICON VEHICLE DYNAMICS RECOMMENDS THAT YOU EXERCISE EXTREME CAUTION WHEN WORKING UNDER A VEHICLE THAT IS SUPPORTED WITH JACK STANDS.
** ICON VEHICLE DYNAMICS RECOMMENDS ALL INSTALLATION TO BE PERFORMED BY A PROFESSIONAL SHOP/SERVICE TECHNICIAN. PRODUCT FAILURE CAUSED BY IMPROPER INSTALLATION WILL NOT BE COVERED UNDER ICON'S WARRANTY POLICY.

## INSTALLATION

- For easy access to the rear lower links, lift vehicle and securely place heavy duty jack stands under the manufacturer recommended lifting locations for the front of the vehicle. Take care when lifting the vehicle, and allow 3-4" of ground clearance from the tire. Remove rear tires. NEVER WORK UNDER AN UNSUPPORTED VEHICLE. Remove the wheels.
- Grab the aluminum clamps and slip them over the ends of the link where the tube is flattened. [FIGURE 1]



FIG.1

- Slide the first clamp down the link, so it is approximately 16.75" from the frame pivot. The second clamp should be about 10" from the frame pivot. Both clamps should be oriented with the hose clamp section facing up.

If the clamp is too tight to slide over the tube, grab an adjustable pliers and squeeze the 'U' which will open up the tube section and allow it to slide. (Wrap the plier jaws with a rag or tape to keep from scratching the clamps). [FIGURE 2]



FIG.2

4. With the clamps in the correct position on the link, position the reservoir hose into the clamp and thread the supplied 10-24 x 1.25" set screw into the clamp, position the supplied black PVC tubing over the set screw and tighten. [FIGURE 3 & 4]



FIG.3

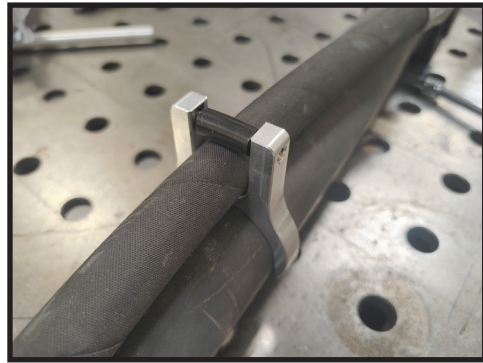

FIG.4

5. The reservoir hose should still move freely. Do not try to tighten the set screw down so much that the hose becomes tight, you could break the clamp.

6. Repeat steps on opposite side.

7. Reinstall wheels and tires, torque lug nuts to factory spec.

**VERIFY ALL FASTENERS ARE PROPERLY TORQUED BEFORE DRIVING VEHICLE.**

**RETORQUE ALL NUTS, BOLTS AND LUGS AFTER 100 MILES AND PERIODICALLY THEREAFTER.**

### **ICON VEHICLE DYNAMICS LIMITED LIFETIME WARRANTY**

ICON Vehicle Dynamics warrants to the original retail purchaser who owns the vehicle on which the product was originally installed. ICON Vehicle Dynamics does not warrant the product for finish, alterations, modifications and/or installation contrary to ICON Vehicle Dynamics instructions. ICON Vehicle Dynamics products are not designed, nor are they intended to be installed on vehicles used in race applications, for racing purposes or for similar activities. (A "race" is defined as any contest between two or more vehicles, or a contest of one or more vehicles against the clock, whether or not such contest is for a prize). This warranty does not include coverage for police or taxi vehicles, race vehicles, or vehicles used for government or commercial purposes. Also excluded from this warranty are sales outside of the United States of America and Canada.

ICON Vehicle Dynamics' obligation under this warranty is limited to the repair or replacement, at ICON Vehicle Dynamics' discretion, of the defective product. Any and all costs of removal, installation or re-installation, freight charges and incidental or consequential damages are expressly excluded from this warranty. Items that are subject to wear are not considered defective when worn and are not covered.

ICON Vehicle Dynamics components must be installed as a complete kit as shown in our current application guide. Any substitutions or exemptions of required components will immediately void the warranty. Some finish damage may happen to parts during shipping and is not covered under warranty.

This warranty is expressly in lieu of all other warranties expressed or implied. This warranty shall not apply to any product that has been improperly installed, modified or customized subject to accident, negligence, abuse or misuse.



**ICON VEHICLE DYNAMICS®**  
PERFORMANCE SUSPENSION SYSTEMS AND SHOCK ABSORBERS

7929 Lincoln Ave. Riverside, CA 92504 Phone: 951.689.ICON Fax: 951.689.1016  
[www.iconvehicledynamics.com](http://www.iconvehicledynamics.com)



**FOLLOW US ON FACEBOOK!**

