



# INSTALLATION INSTRUCTIONS

## 2021+ FORD BRONCO ROOF RACK SR MOUNT KIT



### PRODUCTS INCLUDE:

- (2) MOUNTS #46725
- \*Lights sold separately.

### RECOMMENDED TOOLS:

- T30 Torx bit

- 7/16" Socket

### IMPORTANT

THANK YOU FOR PURCHASING RIGID INDUSTRIES' PRODUCTS FOR YOUR VEHICLE.

Please read through all of these Instructions and tips before proceeding with the installation. We do our best to provide a simple installation process for all applications however a professional installation is always recommended.

**Always disconnect any power sources connected to your vehicle before servicing fuses or electrical systems.**

### STEP: 1

Remove the factory bolts from the rack with a T30 Torx.



# RIGID® INSTALLATION INSTRUCTIONS

## STEP: 2

Install the rubber isolator into each bracket as shown in the photo.

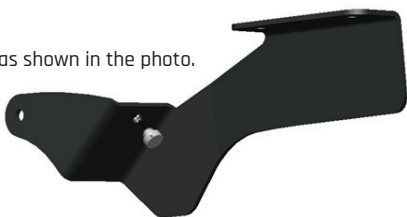

## STEP: 3

Install the brackets to the light on both sides as shown below. Use the hardware included with the light and the black washers included in this kit.

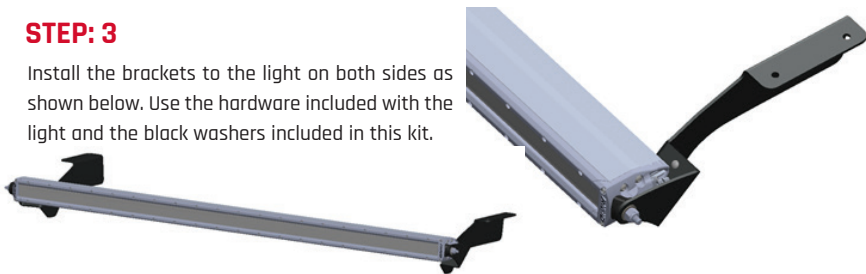

## STEP: 4

Install brackets to the roof rack using the supplied hardware, using a T30 Torx to install. Torque to 8Nm (70.8 in-lbs).



## STEP: 5

Tighten the nuts on each end of the light bar using a 7/16" socket. Then use the supplied rubber caps to finish the install. Recommended routing for light wiring is along the top edge of the roof line. Peel back rubber seal for access (image continued on the next page).



# RIGID® INSTALLATION INSTRUCTIONS

## STEP: 5 CONTINUED

Peel back rubber seal for access.



## STEP: 6

Insert the air dampener into the bottom fins located on the rear of the light to reduce wind noise.

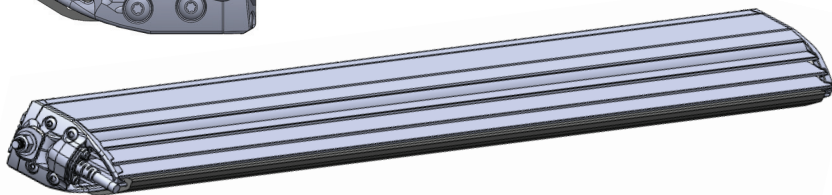
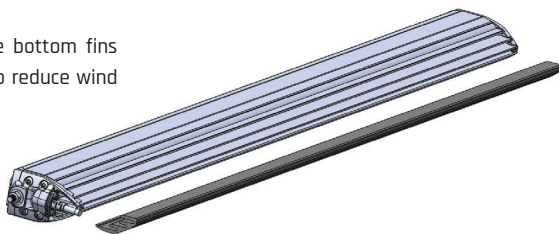
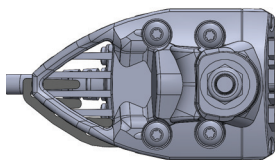

**Wiring:** Wire your lights according to the instructions included with the light. Take care to avoid any heat sources and sharp or abrasive surfaces.

Your installation is now complete.  
**Welcome to the Rigid Nation!**

### WARRANTY INFORMATION

For warranty information, visit [www.rigidindustries.com/about/warranty](http://www.rigidindustries.com/about/warranty) 779 N Colorado St, Gilbert, AZ 85233 • 855-760-5337  
[www.rigidindustries.com](http://www.rigidindustries.com)

RIGID, SR-Series and Rigid Industries are registered and/or common law marks owned by JST Performance, LLC, a Delaware limited liability company d/b/a Rigid Industries.

11-13981-B



*SA-SERIES®*

*SA-SERIES®*

*SA-SERIES®*  
**INSTALLATION INSTRUCTIONS**



**KIT INCLUDES**

- |                              |   |
|------------------------------|---|
| (2) ¼" Hex Head Bolt         | (2) Tall Mounting Bracket               |
| (2) ¼" Nylon Insert Lock Nut | (2) Compression Spacers                 |
| (2) ¼" Flat Washer           | (1) Light Bar                           |
| (2) Short Mounting Bracket   | (1) Wire Harness with 2 Position Switch |

**IMPORTANT**

Thank you for purchasing Rigid Industries' products. Installation is fairly simple with the right tools and good mechanical abilities. If you are not confident in your mechanical skills, please seek the help of a professional to perform the installation. Please read through all of these instructions and tips before proceeding with the installation. **It is strongly recommended that this product be installed by a professional.**

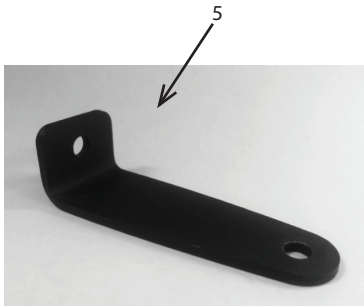
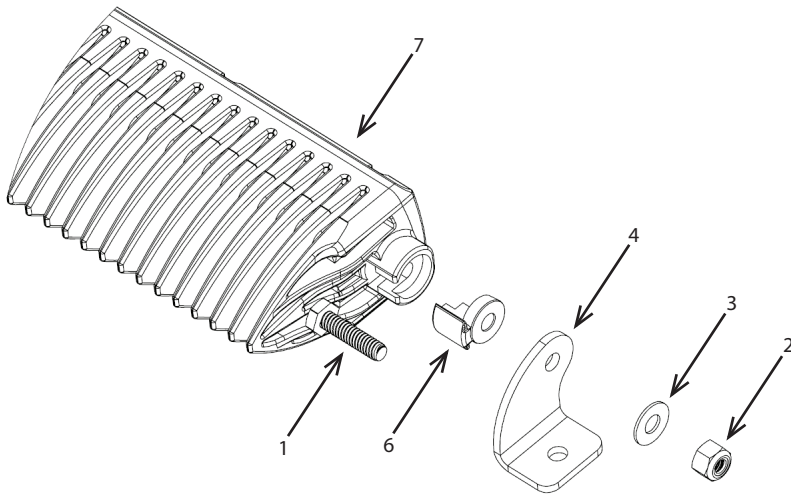

**\* Install the Tall Mounting Bracket (5) in place of the Short Mounting Bracket (4) if a taller mounting position is desired\***

Item	Description	Qty Single
1	¼" Hex Head Bolt	2
2	¼" Nylon Insert Lock Nut	2
3	¼" Flat Washer	2
4	Short Mounting Bracket	2
5	Tall Mounting Bracket	2
6	Compression Spacers	2
7	Light Bar	1
8	Wire Harness with 2 Position Switch	1

**Always disconnect any power sources connected to your vehicle before servicing fuses or electrical systems.**

## STEP 1

The SR Series® light bar includes bolts that slide into each side of the light before compression spacers and brackets are attached for mounting. Insert mounting brackets onto the light as shown in Figure 1. Secure hardware and mount light onto desired location.

Figure 1:

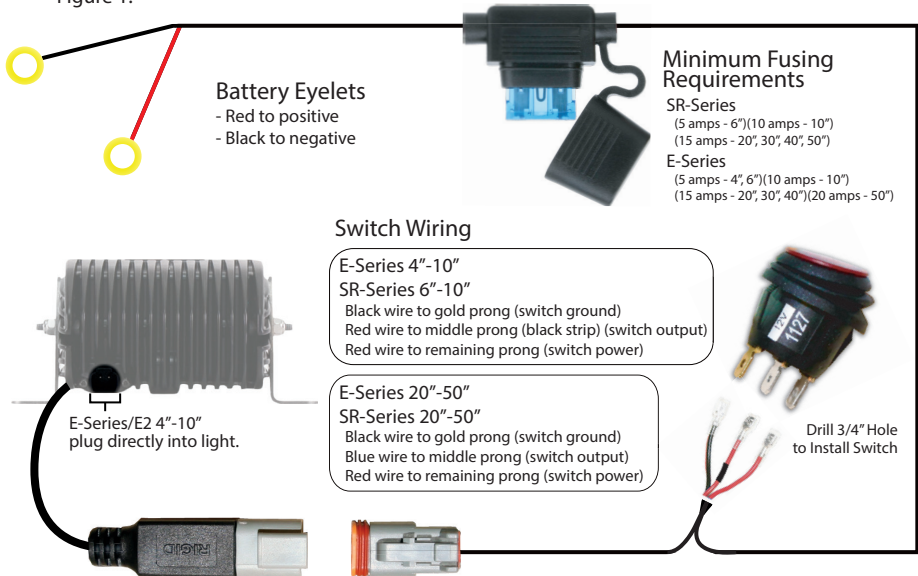

## STEP 2

Attach the eyelet at the end of the red wire to the positive terminal of your battery or to any 12V DC source. Secure the black wire to the negative battery terminal or any suitable ground as shown in Figure 2. Route the wire harness to the desired switch secure with zip ties. Take care to avoid any heat sources and sharp or abrasive surfaces. When installing Rigid lights on a 24V DC system use a 24V relay. When installing multiple lights be sure to use adequate fusing.

## STEP 3

Test lights to ensure proper function and secure mounting hardware according to desired light beam angle.



**Your installation is now complete.**

**Welcome to the Rigid Nation!**



## WARRANTY INFORMATION

Rigid Industries warrants that this product will be free from defects in material and workmanship. If you believe your Rigid Industries product is defective, it must be returned to Rigid Industries for inspection by our warranty claims department. If, after inspection, Rigid Industries verifies that the defect was not caused by negligence, abuse, unauthorized repair or disassembly, Rigid Industries will determine whether the product will be repaired or replaced in accordance with Rigid Industries Limited Lifetime Warranty\*.

### **Warranty Periods:**

- All LED Lights – Limited Lifetime
- Flashlights – 1 year
- Accessories and Mounts – 2 years
- Batteries – 90 days

### **Warranty Coverage:**

To begin your warranty claim, you must have a Return Merchandise Authorization (RMA) number. To get your RMA number, please contact our warranty department by phone at 480-655-0100 ext. 1008, or by filling out the Return Merchandise Authorization Form on our website.

All of the following will immediately void all warranties:

- Customer negligence – The customer has modified the light and/or is not using it for the recommend application.
- Customer abuse – Damage to the light beyond normal wear and tear.
- Repair work done by unauthorized personnel without Rigid Industries' approval.
- If the light has been opened or any screws have been removed.

All warranties are non-transferable. Warranty terms and policies are subject to change without notice.

\*For all information regarding the Rigid Industries' Limited Lifetime Warranty please call 855-760-5337 ext. 1008, email [warranty@RigidIndustries.com](mailto:warranty@RigidIndustries.com), or visit our warranty page online at [rigidindustries.com/about/warranty](http://rigidindustries.com/about/warranty).

**Follow us on facebook at**

[Facebook.com/RigidIndustries](https://www.facebook.com/RigidIndustries)

779 N Colorado St, Gilbert, AZ 85233 • 855-760-5337 ext 1008 • [www.rigidindustries.com](http://www.rigidindustries.com)

PKG-IS-134 REV1

SR-Series and Rigid Industries are registered and/or common law marks owned by JST Performance, Inc. d/b/a Rigid Industries.